

**International Journal on**

**Advances in Life Sciences**

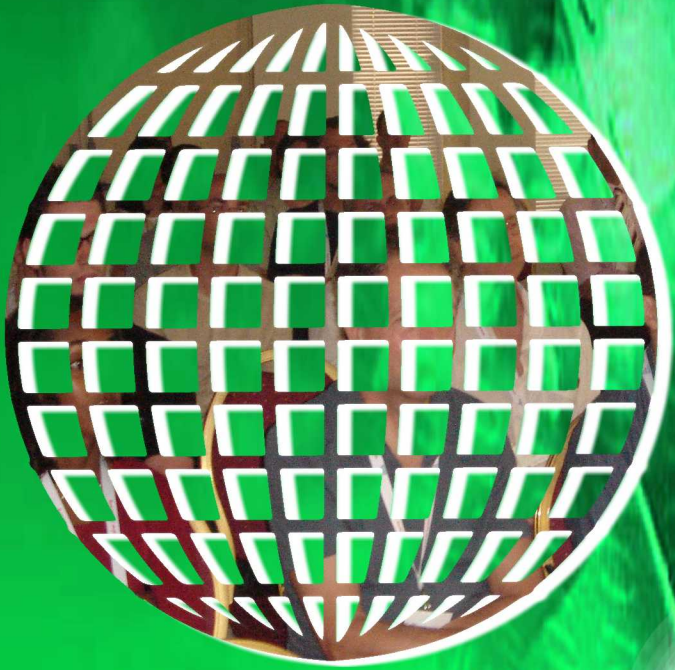

2018 vol. 10 nr. 3&4

The *International Journal on Advances in Life Sciences* is published by IARIA.

ISSN: 1942-2660

journals site: <http://www.ariajournals.org>

contact: [petre@aria.org](mailto:petre@aria.org)

Responsibility for the contents rests upon the authors and not upon IARIA, nor on IARIA volunteers, staff, or contractors.

IARIA is the owner of the publication and of editorial aspects. IARIA reserves the right to update the content for quality improvements.

Abstracting is permitted with credit to the source. Libraries are permitted to photocopy or print, providing the reference is mentioned and that the resulting material is made available at no cost.

Reference should mention:

*International Journal on Advances in Life Sciences, issn 1942-2660*  
*vol. 10, no. 3 & 4, year 2018, [http://www.ariajournals.org/life\\_sciences/](http://www.ariajournals.org/life_sciences/)*

The copyright for each included paper belongs to the authors. Republishing of same material, by authors or persons or organizations, is not allowed. Reprint rights can be granted by IARIA or by the authors, and must include proper reference.

Reference to an article in the journal is as follows:

<Author list>, "<Article title>"  
*International Journal on Advances in Life Sciences, issn 1942-2660*  
*vol. 10, no. 3 & 4, year 2018, <start page>:<end page>, [http://www.ariajournals.org/life\\_sciences/](http://www.ariajournals.org/life_sciences/)*

IARIA journals are made available for free, proving the appropriate references are made when their content is used.

Sponsored by IARIA

[www.aria.org](http://www.aria.org)

Copyright © 2018 IARIA

**Editor-in-Chief**

Lisette Van Gemert-Pijnen, University of Twente - Enschede, The Netherlands  
Marieke Hettinga, Windesheim University of Applied Sciences, The Netherlands

**Editorial Advisory Board**

Åsa Smedberg, Stockholm University, Sweden  
Piero Giacomelli, SPAC SPA -Arzignano (Vicenza), Italia  
Ramesh Krishnamurthy, Health Systems and Innovation Cluster, World Health Organization - Geneva, Switzerland  
Anthony Glascock, Drexel University, USA  
Hassan Ghazal, Moroccan Society for Telemedicine and eHealth, Morocco  
Hans C. Ossebaard, University of Twente, the Netherlands  
Juergen Eils, DKFZ, German  
Trine S Bergmo, Norwegian Centre for Integrated Care and Telemedicine, Norway  
Anne G. Ekeland, Norwegian Centre for Integrated Care and Telemedicine / University Hospital of North Norway |  
University of Tromsø, Norway  
Kari Dyb, Norwegian Centre for Integrated Care and Telemedicine / University Hospital of North Norway |  
University of Tromsø, Norway  
Hassan Khachfe, Lebanese International University, Lebanon  
Ivan Evgeniev, TU Sofia, Bulgaria  
Matthieu-P. Schapranow, Hasso Plattner Institute, Germany

**Editorial Board**

Dimitrios Alexandrou, UBITECH Research, Greece  
Giner Alor Hernández, Instituto Tecnológico de Orizaba, Mexico  
Ezendu Ariwa, London Metropolitan University, UK  
Eduard Babulak, University of Maryland University College, USA  
Ganesharam Balagopal, Ontario Ministry of the Environment, Canada  
Kazi S. Bennoor, National Institute of Diseases of Chest & Hospital - Mohakhali, Bangladesh  
Trine S Bergmo, Norwegian Centre for Integrated Care and Telemedicine, Norway  
Jorge Bernardino, ISEC - Institute Polytechnic of Coimbra, Portugal  
Tom Bersano, University of Michigan Cancer Center and University of Michigan Biomedical Engineering  
Department, USA  
Werner Beuschel, IBAW / Institute of Business Application Systems, Brandenburg, Germany  
Razvan Bocu, Transilvania University of Brasov, Romania  
Freimut Bodendorf, Universität Erlangen-Nürnberg, Germany  
Eileen Brebner, Royal Society of Medicine - London, UK  
Julien Broisin, IRIT, France  
Sabine Bruaux, Sup de Co Amiens, France  
Dumitru Burdescu, University of Craiova, Romania

Vanco Cabukovski, Ss. Cyril and Methodius University in Skopje, Republic of Macedonia  
Yang Cao, Virginia Tech, USA  
Rupp Carriveau, University of Windsor, Canada  
Maiga Chang, Athabasca University - Edmonton, Canada  
Longjian Chen, College of Engineering, China Agricultural University, China  
Dickson Chiu, Dickson Computer Systems, Hong Kong  
Bee Bee Chua, University of Technology, Sydney, Australia  
Udi Davidovich, Amsterdam Health Service - GGD Amsterdam, The Netherlands  
Maria do Carmo Barros de Melo, Telehealth Center, School of Medicine - Universidade Federal de Minas Gerais (Federal University of Minas Gerais), Brazil  
Kari Dyb, Norwegian Centre for Integrated Care and Telemedicine / University Hospital of North Norway | University of Tromsø, Norway  
Juergen Eils, DKFZ, German  
Anne G. Ekeland, Norwegian Centre for Integrated Care and Telemedicine / University Hospital of North Norway | University of Tromsø, Norway  
El-Sayed M. El-Horbaty, Ain Shams University, Egypt  
Ivan Evgeniev, TU Sofia, Bulgaria  
Karla Felix Navarro, University of Technology, Sydney, Australia  
Joseph Finkelstein, The Johns Hopkins Medical Institutions, USA  
Stanley M. Finkelstein, University of Minnesota - Minneapolis, USA  
Adam M. Gadomski, Università degli Studi di Roma La Sapienza, Italy  
Ivan Ganchev, University of Limerick, Ireland / University of Plovdiv "Paisii Hilendarski", Bulgaria  
Jerekias Gandure, University of Botswana, Botswana  
Xiaohong Wang Gao, Middlesex University - London, UK  
Josean Garrués-Irurzun, University of Granada, Spain  
Hassan Ghazal, Moroccan Society for Telemedicine and eHealth, Morocco  
Piero Giacomelli, SPAC SPA -Arzignano (Vicenza), Italia  
Alejandro Giorgetti, University of Verona, Italy  
Anthony Glascock, Drexel University, USA  
Wojciech Glinkowski, Polish Telemedicine Society / Center of Excellence "TeleOrto", Poland  
Francisco J. Grajales III, eHealth Strategy Office / University of British Columbia, Canada  
Conceição Granja, Conceição Granja, University Hospital of North Norway / Norwegian Centre for Integrated Care and Telemedicine, Norway  
William I. Grosky, University of Michigan-Dearborn, USA  
Richard Gunstone, Bournemouth University, UK  
Amir Hajjam-El-Hassani, University of Technology of Belfort-Montbéliard, France  
Lynne Hall, University of Sunderland, UK  
Päivi Hämäläinen, National Institute for Health and Welfare, Finland  
Anja Henner, Oulu University of Applied Sciences, Finland  
Marika Hettinga, Windesheim University of Applied Sciences, Netherlands  
Stefan Hey, Karlsruhe Institute of Technology (KIT) , Germany  
Dragan Ivetic, University of Novi Sad, Serbia  
Sundaresan Jayaraman, Georgia Institute of Technology - Atlanta, USA  
Malina Jordanova, Space Research & Technology Institute, Bulgarian Academy of Sciences, Bulgaria  
Attila Kertesz-Farkas, University of Washington, USA  
Hassan Khachfe, Lebanese International University, Lebanon



Valentinas Klevas, Kaunas University of Technology / Lithuaniaian Energy Institute, Lithuania  
Anant R Koppar, PET Research Center / KTwo technology Solutions, India  
Bernd Krämer, FernUniversität in Hagen, Germany  
Ramesh Krishnamurthy, Health Systems and Innovation Cluster, World Health Organization - Geneva, Switzerland  
Roger Mailler, University of Tulsa, USA  
Dirk Malzahn, OrgaTech GmbH / Hamburg Open University, Germany  
Salah H. Mandil, eStrategies & eHealth for WHO and ITU - Geneva, Switzerland  
Herwig Mannaert, University of Antwerp, Belgium  
Agostino Marengo, University of Bari, Italy  
Igor V. Maslov, EvoCo, Inc., Japan  
Ali Masoudi-Nejad, University of Tehran , Iran  
Cezary Mazurek, Poznan Supercomputing and Networking Center, Poland  
Teresa Meneu, Univ. Politécnic de Valencia, Spain  
Kalogiannakis Michail, University of Crete, Greece  
José Manuel Molina López, Universidad Carlos III de Madrid, Spain  
Karsten Morisse, University of Applied Sciences Osnabrück, Germany  
Ali Mostafaeipour, Industrial engineering Department, Yazd University, Yazd, Iran  
Katarzyna Musial, King's College London, UK  
Hasan Ogul, Baskent University - Ankara, Turkey  
José Luis Oliveira, University of Aveiro, Portugal  
Hans C. Ossebaard, National Institute for Public Health and the Environment - Bilthoven, The Netherlands  
Carlos-Andrés Peña, University of Applied Sciences of Western Switzerland, Switzerland  
Tamara Powell, Kennesaw State University, USA  
Cédric Pruski, CR SANTEC - Centre de Recherche Public Henri Tudor, Luxembourg  
Andry Rakotonirainy, Queensland University of Technology, Australia  
Robert Reynolds, Wayne State University, USA  
Joel Rodrigues, Institute of Telecommunications / University of Beira Interior, Portugal  
Alejandro Rodríguez González, University Carlos III of Madrid, Spain  
Nicla Rossini, Université du Luxembourg / Università del Piemonte Orientale / Università di Pavia, Italy  
Addisson Salazar, Universidad Politecnica de Valencia, Spain  
Abdel-Badeeh Salem, Ain Shams University, Egypt  
Matthieu-P. Schapranow, Hasso Plattner Institute, Germany  
Åsa Smedberg, Stockholm University, Sweden  
Chitsutha Soomlek, University of Regina, Canada  
Monika Steinberg, University of Applied Sciences and Arts Hanover, Germany  
Jacqui Taylor, Bournemouth University, UK  
Andrea Valente, University of Southern Denmark, Denmark  
Jan Martijn van der Werf, Utrecht University, The Netherlands  
Liezl van Dyk, Stellenbosch University, South Africa  
Lisette van Gemert-Pijnen, University of Twente, The Netherlands  
Sofie Van Hoecke, Ghent University, Belgium  
Iraklis Varlamis, Harokopio University of Athens, Greece  
Genny Villa, Université de Montréal, Canada  
Stephen White, University of Huddersfield, UK  
Levent Yilmaz, Auburn University, USA  
Eiko Yoneki, University of Cambridge, UK

**CONTENTS**

*pages: 127 - 137*

**A Quantitative Assessment of the Microbiological Quality of Lebanese Tahini (Sesame Paste)**

Zeinab Alaouie, International University of Beirut, Lebanon  
Ali AlKhatib, International University of Beirut, Lebanon  
Hassan M. Khachfe, Lebanese International University, Lebanon

*pages: 138 - 146*

**An Electronic Nose using a Protein-Biosensor and a Camera-Based Application**

Noor Alrabeeh, Lebanese International University, Lebanon  
Omar Osman, Lebanese International University, Lebanon  
Ali Hage-Diab, Lebanese International University, Lebanon  
Houssein Hajj-Hassan, Lebanese International University, Lebanon  
Hassan M. Khachfe, Lebanese International University, Lebanon

*pages: 147 - 155*

**“OPeN” - The National Adverse Reactions Database in the Croatian eHealth System**

Arian Rajh, Agency for Medicinal Products and Medical Devices of Croatia, Croatia  
Dubravka Sudić, Agency for Medicinal Products and Medical Devices of Croatia, Croatia  
Katarina Gvozdanović, Agency for Medicinal Products and Medical Devices of Croatia, Croatia

*pages: 156 - 168*

**Evaluating an Evidence-Based mHealth Application, MS Assistant, for Individuals Aging with Multiple Sclerosis**

Ljilja Ruzic, Georgia Institute of Technology, United States  
Harshal Mahajan, Georgia Institute of Technology, United States  
Jon Sanford, Georgia Institute of Technology, United States

*pages: 169 - 182*

**Achieving Good Worklife Ergonomics in eHealth Co-Creation -The ‘What’, the ‘Why’ and the ‘How’**

Niels Frederik Garmann-Johnsen, NORCE - Norwegian Research Center, and University of Agder, Norge  
Migle Helmersen, NORCE - Norwegian Research Center, Norge  
Tom Roar Eikebrokk, University of Agder, Norge

*pages: 183 - 197*

**The Physiometrics as the Main Principle of architectural Forming and Aesthetic Emotions**

Olga Chebereva, Nizhny Novgorod State University of Architecture and, Russia

*pages: 198 - 210*

**Feature Extraction from Body Postures: Towards an Emotion Recognition System Based on Digital Imaging**

Bruno Barbosa, University of Aveiro, Portugal  
Antonio Neves, University of Aveiro, Portugal  
Sandra C. Soares, University of Aveiro, Portugal  
Isabel Dimas, University of Aveiro, Portugal

*pages: 211 - 220*

**Analyzing the Potential Occurrence of Osteoporosis and its Correlation to Cardiovascular Disease Using**

**Predictive Analytic**

Kae Sawada, Jet Propulsion Laboratory, United States

Michael Wayne Clark, Pasadena City College, United States

Zilong Ye, California State University, Los Angeles, United States

Nabil Alshurafa, Northwestern University, United States

Mohammad Pourhomayoun, California State University, Los Angeles, United States

*pages: 221 - 231*

**The Sustainable Growth Use of Renewable Energy Based on Spatial Energy Planning: Lithuanian Case**

Valentinas Klevas, Lithuanian Energy Institute, Lithuania

Audrone Kleviene, Lithuanian Energy Institute, Lithuania

*pages: 232 - 239*

**A Smart Healthcare Tracking and Monitoring System**

Ali Bazzi, International University of Beirut, BIU, Lebanon

Majd Ghareeb, International University of Beirut, BIU, Lebanon

Samih Abdul-Nabi, International University of Beirut, BIU, Lebanon

Muslem Ghamloush, Lebanese Institute for Biomedical Research and Application Lebanese International University, LIU, Lebanon

Mostafa Ibrahim, Lebanese Institute for Biomedical Research and Application Lebanese International University, LIU, Lebanon

Hassan Khachfe, Lebanese Institute for Biomedical Research and Application Lebanese International University, LIU, Lebanon

## A Quantitative Assessment of the Microbiological Quality of Lebanese Tahini (Sesame Paste)

Zeinab Alaouie, Ali AlKhatib

Department of Nutrition and Food Sciences  
International University of Beirut  
Beirut, Lebanon

Email: zeinab.h.alaouie@gmail.com, ali.alkhatib@b-  
iu.edu.lb

Hassan M. Khachfe

Lebanese Institute for Biomedical Research and Application  
(LIBRA)  
Lebanese International University

Beirut, Lebanon

Email: hassan.khachfe@liu.edu.lb

**Abstract**-The microbiological quality of tahini produced by several manufacturers in Lebanon was evaluated. Sixty-three tahini samples were collected randomly from retail markets throughout the country with production dates ranging from October 2015 to September 2017. The majority of the samples were from companies that are international exporters of the product. Nine of the obtained samples were from a traditional tahini manufacturer. All samples were assessed for the total Aerobic Plate Count, the presence and enumeration of *Staphylococcus aureus*, yeasts and molds, *Salmonella*, coliforms and *Escherichia coli*. Spread plate methods were used for detection and enumeration. The following results were obtained: the Aerobic Plate Count of the samples ranged between  $1 \times 10^2$  CFU/g and  $8.2 \times 10^5$  CFU/g with an average of  $8.2 \times 10^4$  CFU/g. *S. aureus* counts ranged between  $<20$  CFU/g and  $9.2 \times 10^3$  CFU/g with an average of  $8.3 \times 10^2$  CFU/g. Yeasts and molds were present at counts ranging from  $<10$  CFU/g to  $2.2 \times 10^5$  CFU/g with an average of  $2.5 \times 10^4$  CFU/g. Total coliform counts ranged between  $<30$  CFU/g and  $3.4 \times 10^5$  CFU/g with an average of  $2.3 \times 10^4$  CFU/g. *E. coli* was present in ~37% of the samples (23 out of 63), while *Salmonella* was confirmed present in ~16% of the samples (10 out of 63). When compared with local and international standards, many of the samples showed unacceptable levels of microbial contamination. Certain impact factors were also determined when the samples were grouped according to their respective manufacturer, age, and processing method.

**Keywords**-Tahini; Sesame Paste; Microbiology; Lebanon.

### I. INTRODUCTION

Tahini is a well-known Middle Eastern condiment made from toasted ground hulled sesame seeds [1]. The paste has gained popularity all over the globe as a result of its health and culinary benefits [2]. In 2014, the Middle East and Mediterranean tahini market was estimated to be at a value of \$783.9 Million, with forecasts of a further escalation by 2020. Lebanon has been an important exporter of tahini, and is home to many key players in the market [3].

The importance of tahini comes from the fact that it is used commercially and at a household level as an ingredient in many cultural delicacies. These include products that have gained international popularity, such as hummus (chickpeas with tahini), and mtabal betegen (roasted eggplant and tahini) [4]. The paste is also used as a sauce for meats like *shawarma*, and as a sauce (known as *tarator*) for fish and *falafel*. Tahini also makes up about 50% of *halwa*

(or *halawa*), a sweet made up of tahini, sugar, citric acid and *Saponaria officinalis* root extract [5]. Tahini is of high nutritive value. It is rich in lipids, proteins, carbohydrates, niacin, thiamin, and some minerals like calcium, and phosphorous [6]. The traditional way of tahini processing in Lebanon includes: sorting the seeds to remove dark or imperfect seeds, followed by soaking the seeds in salt water. This helps settle impurities and dirt at the bottom and ease the peeling process. The seeds that are floating on the surface of the water are then collected, peeled and washed. The next step involves roasting the seeds, followed by the stone-grinding phase, which brings out the oil in the sesame and turns it into a paste. Many tahini manufacturers, however, rely on a fully automated process. Instead of soaking the seeds in salt water, they are passed into a centrifuge that separates any impurities. The sesame then enters a washing machine, followed by a drying machine and then a roaster. The roasted sesame is cleaned once again and sorted by color. The accepted seeds then undergo grinding, are homogenized and then finally pasteurized at a high temperature for several hours to get rid of any potential bacteria [7][8] (Figure 1).

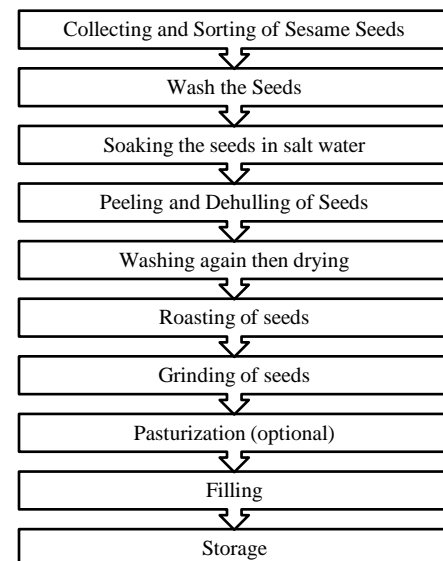

Figure 1. Schematic diagram showing the basic steps for tahini processing from sesame seeds.

After production tahini is stored at room temperature and has a shelf life up to 2 years [9]. It is typically consumed directly and does not require any further processing. Therefore, it should be free from any pathogenic bacteria upon packaging. The raw sesame itself should also be free from microbes, so as not to increase the risk of contamination [10]. However, despite the development of a hazard analysis critical control point (HACCP) plan for the manufacturing of tahini [11], in recent years, sesame paste has emerged as a product of concern, with many of the end products containing *Salmonella*, *Staphylococcus aureus*, *Escherichia coli*, and a number of other hazardous microbes. In addition tahini has a low water activity (~0.16) as well as low pH (~5.9) [11], conditions that permit the growth of many foodborne microorganisms [12].

The presence of microbes has been attributed to a number of reasons including, the microbial quality of sesame seeds, poor hygiene and sanitation, and improper processing and storage conditions [10]. Outbreaks of *Salmonella* infections have been traced back to tahini, some particularly correlated with Lebanese products [13]. Though some studies have dealt with the microbiological quality of sesame seed products, a collective investigation into tahini products in Lebanon using conventional plating methods has yet to be established. Therefore, the objective of this study will be to detect and enumerate microbial contamination of tahini in Lebanon, while also checking for possible impact factors including the processing method, storage time, or difference among products due to difference in manufacturer.

This paper includes four sections. Aside from the introduction, Section II includes a detailed description of the materials and methods used in the study. In Section III we mention the microbial results obtained and whether grouping the samples according to their corresponding manufacturer, method of processing, or sample age may have had an impact on the obtained results, which we discuss in accordance to similar studies. In the final section, Section IV, we wrap up our research in a concluding statement and mention some limitations, as well as possible future work in the related area.

## II. MATERIALS AND METHODS

### A. Sampling

Sixty-three tahini samples with production dates varying from October 2015 to September 2017 were collected from retailers and producers throughout certain areas in Lebanon. Nine of the samples were obtained from a traditional manufacturer (no automated machinery). Sample weights varied between 200g and 900g. All samples were held at room temperature (25°C) and collected in their original packages, which were wiped with ethanol before testing. The samples were given a letter based on the manufacturer as shown in Table I. Using a sterilized rod, the samples were thoroughly mixed. 25 g of each sample were then transferred aseptically into separate sterile plastic bags containing 225 ml of buffered peptone water for homogenization. Homogenization was carried out using a

stomacher (Model, 1605 BL Smart) for 2 minutes. Following homogenization ten-fold serial dilutions up to  $10^3$  were prepared, and inoculated on appropriate media.

### B. Microbial Analysis

Aerobic Plate Counts (APC), *Staphylococcus aureus*, coliforms, and yeasts/mold counts were determined for each sample, as well as the presence or absence of *Escherichia coli*, and *Salmonella*.

**Aerobic Plate Count.** APC was determined according to the procedure specified by Morton R.D [14]. 0.1 ml of each dilution was inoculated and spread onto Plate Count Agar (PCA) (HiMedia) and left to dry. The plates were then incubated at  $35 \pm 1^\circ\text{C}$  for  $48 \pm 2$  hours.

***Staphylococcus aureus.*** *S. aureus* was detected and enumerated via surface plating 0.5 ml on Mannitol Salt Agar (MSA) (HiMedia) and incubating plates at  $35 \pm 1^\circ\text{C}$  for  $48 \pm 2$  hours. Colonies with typical and atypical *S. aureus* morphology were confirmed by the catalase and coagulase tests. This method is in accordance with that specified by the British Standards Institution, with a modification of the agar [15].

**Yeast and Mold.** Yeast and mold counts were determined following spread plate inoculation onto Sabouraud Dextrose Agar (SDA) (HiMedia). Plates were incubated at  $25 \pm 1^\circ\text{C}$  for 5 days. This procedure was taken from the United States Food and Drug administration (FDA) [16] however the proposed agar was substituted with SDA.

**Total coliforms and *Escherichia coli*.** Total coliforms were enumerated on Eosin Methylene Blue Agar (EMB) (HiMedia) [17]. An addition to the procedure determined by Gehm & Heukelekian included pre-enrichment of 1 ml of the samples with 10 ml Lactose Broth (HiMedia) for 48 hours, at an incubation temp of  $35 \pm 1^\circ\text{C}$ . Following the pre-enrichment step, 1 ml of each dilution was surface plated onto EMB agar plates and incubated at  $35 \pm 1^\circ\text{C}$  for  $48 \pm 2$  hours. Plates with typical *E. coli* colonies were confirmed for presence of the bacteria via biochemical IMViC tests (HiMedia).

***Salmonella.*** For detecting *Salmonella*, the FDA Bacteriological Analytical Manual (BAM) procedure was implemented, with some modifications [18]. Pre-enrichment was carried out by suspending 25g of each sample in 225ml of Lactose Broth (HiMedia), followed by incubation at  $35 \pm 1^\circ\text{C}$  for  $24 \pm 2$  hours. 1 ml of each sample was then transferred to 10 ml tubes of Selenite F Broth (SFB) (HiMedia) and incubated at  $35 \pm 1^\circ\text{C}$  for  $24 \pm 2$  hours. After incubation, 3 mm loopfuls were streaked onto *Salmonella* Shigella agar (SS)(HiMedia) and incubated for another  $24 \pm 2$  hours. Typical and atypical colonies for presumptive *Salmonella* were then transferred to Kligler Iron Agar (KIA) (HiMedia). Confirmation was carried out via IMViC biochemical tests (HiMedia), Urea Broth (HiMedia), and Phenol D broth (HiMedia).

### C. Statistical analysis

The data was analyzed using analysis of variance (ANOVA) completely randomized design. Differences

among means of the treatments were analyzed using Duncan. Significant differences were determined when  $p \leq 0.05$ . Significant differences for means obtained after grouping the samples based on the processing method, were determined using independent t-test analysis.

### III. RESULTS AND DISCUSSION

#### A. Microbial Counts

APC, *S. aureus*, total coliform, and yeast and mold counts, as well as the presence or absence of *Salmonella* and *E. coli* obtained following assessment of sixty-three tahini samples in Lebanon are shown in Table I. APCs for the samples ranged between  $1 \times 10^2$  colony forming unit per gram (CFU/g) and  $8.2 \times 10^5$  CFU/g with an average of  $8.2 \times 10^4$  CFU/g. *S. aureus* counts ranged between  $<20$  CFU/g and  $9.2 \times 10^3$  CFU/g with an average of  $8.3 \times 10^2$  CFU/g. Yeasts and molds were present at counts ranging from  $<10$  CFU/g to  $2.2 \times 10^5$  CFU/g with an average of  $2.5 \times 10^4$  CFU/g. Total coliform counts ranged between  $<30$  CFU/g and  $3.4 \times 10^5$  CFU/g with an average of  $2.3 \times 10^4$  CFU/g. *E. coli* was present in 36.5% of the samples (23 out of 63), while *Salmonella* was confirmed present in 15.9% of the samples (10 out of 63).

Similar studies have been done on the microbial quality of tahini and similar results were obtained. A similar study in Saudi Arabia, revealed APC levels for 50 tahini samples at an average of  $2 \times 10^4$  CFU/g, slightly lower than the obtained average of the current study [19]. Another study on tahini samples, assessed directly after manufacturing and 4 months after production, was done in Jordan, and the highest average for APC of  $5.3 \times 10^3$  CFU/g was still lower than the obtained average [11]. Al-Sogair et al. (1986) revealed lower averages for *S. aureus* at 56 CFU/g and much lower levels of yeast and mold, ranging from  $<10$  to 50 CFU/g [19]. Yamani & Isa (2006) determined *S. aureus* levels to also be at 54 CFU/g respectively while the average for yeast and mold counts was  $1 \times 10^2$  CFU/g [11]. The current average value for total coliform counts was  $2.3 \times 10^4$  CFU/g, also a high average compared to average counts of 49 CFU/g, and  $6 \times 10^2$  CFU/g for comparable studies [19][11].

This is not the first time *Salmonella* is detected in tahini. The microbial assessment of tahini samples on the shelves of retail markets has led to the recall of some products [20][13]. Al-Sogair et al. (1986), in a similar study, detected *Salmonella* in 20% of the examined samples as well [19].

The microbial quality of sesame paste products, such as halva and hummus, have also been investigated. Figure 2 compares microbial counts obtained from some literature with those obtained from Lebanese manufactured tahini associated with this study, and shows somewhat similar results. However, *S. aureus* levels were the highest in tahini manufactured in Lebanon, while APC and total coliform counts were also the second highest compared to other literature. Comparing these values to standards of acceptance will determine just how much of a health hazard Lebanese tahini is.

TABLE I. LABENESE TAHINI MICROBIAL ANALYSIS RESULTS

Manu- facturer	APC	Microbial Quality CFU/g <sup>a</sup>				
		<i>S. aureus</i>	Yeast/Molds	Total coliforms	<i>E. coli</i>	<i>Salmo- nella</i>
A	$3 \times 10^2$	60	$4 \times 10^2$	$1.4 \times 10^4$	+	-
B	$5 \times 10^2$	60	$1 \times 10^2$	$2.2 \times 10^2$	-	-
C	$4 \times 10^2$	60	$1 \times 10^2$	$3.7 \times 10^3$	+	+
D	$6.8 \times 10^2$	$<20$	$<10$	$7.30 \times 10^3$	+	-
E	$2.3 \times 10^3$	$2.2 \times 10^2$	$<10$	$2.1 \times 10^4$	-	+
F	$7 \times 10^2$	60	$6 \times 10^2$	$>300$	-	+
G	$8.8 \times 10^4$	$3.8 \times 10^2$	$3 \times 10^3$	$3 \times 10^4$	+	-
A	$1 \times 10^2$	$2 \times 10^2$	$<10$	$<30$	-	+
B	$1.2 \times 10^4$	$1.8 \times 10^2$	$6.2 \times 10^3$	$2.5 \times 10^4$	+	-
C	$4.5 \times 10^4$	$9.2 \times 10^3$	$4.4 \times 10^4$	$4.8 \times 10^3$	+	-
D	$3 \times 10^2$	60	$4 \times 10^4$	$6.6 \times 10^2$	-	-
E	$6 \times 10^2$	$<20$	$7 \times 10^2$	$7 \times 10^4$	+	-
F	$1 \times 10^3$	$3.2 \times 10^2$	$1 \times 10^2$	$<30$	-	-
G	$3 \times 10^2$	40	$4 \times 10^2$	$2 \times 10^2$	+	-
A	$7.5 \times 10^3$	$2.8 \times 10^2$	$1.5 \times 10^3$	$2.5 \times 10^3$	-	-
B	$1.4 \times 10^3$	$1.3 \times 10^2$	$1.9 \times 10^3$	$4 \times 10^2$	-	-
C	$3.2 \times 10^3$	$2 \times 10^2$	$8.3 \times 10^3$	$2.3 \times 10^2$	-	+
D	$6.3 \times 10^3$	50	$3 \times 10^2$	$<30$	-	-
E	$2.5 \times 10^3$	$1.1 \times 10^2$	$<10$	$5 \times 10^2$	-	-
F	$2 \times 10^2$	$<20$	$<10$	$2.6 \times 10^3$	+	-
G	$1.2 \times 10^4$	60	$1.2 \times 10^4$	$1.2 \times 10^4$	-	-
A	$7 \times 10^2$	60	$2.3 \times 10^3$	$1.3 \times 10^4$	+	-
B	$1 \times 10^2$	$<20$	$1.5 \times 10^3$	$1 \times 10^2$	-	-
C	$4 \times 10^4$	$1.2 \times 10^2$	$1.5 \times 10^5$	$4 \times 10^2$	+	-
D	$3.1 \times 10^5$	$1.2 \times 10^2$	$7 \times 10^2$	$2.9 \times 10^2$	-	-
E	$2.5 \times 10^2$	$<20$	$1 \times 10^2$	$1.6 \times 10^4$	+	+
F	$6.5 \times 10^4$	$5.6 \times 10^3$	$1.2 \times 10^5$	$4.3 \times 10^3$	+	-
G	$2.3 \times 10^4$	$<20$	$5.2 \times 10^4$	$4.1 \times 10^3$	+	-
A	$5 \times 10^4$	40	$1.8 \times 10^4$	$1 \times 10^2$	-	-
B	$1.5 \times 10^4$	$2.2 \times 10^2$	$7.8 \times 10^4$	$2 \times 10^4$	-	+
C	$2.3 \times 10^5$	$1.6 \times 10^2$	$3.8 \times 10^4$	$4 \times 10^4$	+	-
D	$5 \times 10^2$	$<20$	$6.2 \times 10^3$	$2.2 \times 10^2$	-	-
E	$6 \times 10^3$	80	$3 \times 10^2$	$3.5 \times 10^4$	-	-
F	$2.2 \times 10^3$	$3 \times 10^2$	$1.2 \times 10^4$	$2.2 \times 10^4$	-	-
G	$2 \times 10^2$	$<20$	$1.9 \times 10^4$	$1.5 \times 10^3$	+	-
A	$5.5 \times 10^4$	$3.2 \times 10^2$	$3.4 \times 10^4$	$3.2 \times 10^2$	-	-
B	$6.2 \times 10^5$	$1 \times 10^2$	$1.2 \times 10^5$	$2.2 \times 10^2$	-	-
C	$3.3 \times 10^5$	$5.4 \times 10^2$	$1.1 \times 10^5$	$3.4 \times 10^2$	-	-
D	$3.3 \times 10^5$	80	$6.4 \times 10^3$	$1.2 \times 10^4$	+	-
E	$1.5 \times 10^3$	40	$1.1 \times 10^5$	$9.3 \times 10^4$	-	-
F	$1.1 \times 10^3$	$2.2 \times 10^2$	$8.4 \times 10^3$	$5.2 \times 10^3$	+	-
G	$1.3 \times 10^4$	$<20$	$3.2 \times 10^2$	$1 \times 10^2$	-	-
A	$1.1 \times 10^3$	$6.8 \times 10^2$	$7.8 \times 10^2$	$2.6 \times 10^2$	+	-
B	$1.4 \times 10^3$	$5 \times 10^2$	$1.4 \times 10^4$	$1.8 \times 10^3$	-	-
C	$2.4 \times 10^3$	$3.6 \times 10^2$	$8.2 \times 10^4$	$1.9 \times 10^4$	-	-
D	$1.7 \times 10^4$	$3.4 \times 10^2$	$5.4 \times 10^3$	$3.6 \times 10^2$	+	-
E	$1.5 \times 10^4$	80	$3 \times 10^2$	$5.6 \times 10^2$	-	+
F	$1.2 \times 10^5$	$5 \times 10^3$	$7.6 \times 10^4$	$1.2 \times 10^4$	+	-
G	$5.8 \times 10^3$	$<20$	$9 \times 10^2$	$<30$	-	-
A	$3.3 \times 10^3$	$1.4 \times 10^3$	$4.5 \times 10^4$	$2 \times 10^2$	-	-
B	$1 \times 10^4$	$1.2 \times 10^3$	$6 \times 10^2$	$<30$	-	+
C	$9.6 \times 10^3$	$9.2 \times 10^3$	$2.1 \times 10^2$	$6.3 \times 10^2$	-	-
D	$2.4 \times 10^4$	$3.6 \times 10^2$	$7 \times 10^2$	$2.3 \times 10^3$	+	-
E	$8.3 \times 10^3$	$8.8 \times 10^2$	$3.3 \times 10^4$	$9.2 \times 10^2$	-	-
F	$5.3 \times 10^3$	$<20$	$2.4 \times 10^3$	$1.6 \times 10^2$	-	-
G	$1.5 \times 10^3$	$<20$	900	$<30$	-	-
A	$5.3 \times 10^4$	$2.4 \times 10^2$	$8.2 \times 10^3$	$5.2 \times 10^2$	-	-
B	$3.2 \times 10^5$	40	$5.6 \times 10^4$	60	-	-
C	$2.5 \times 10^3$	$6.6 \times 10^3$	$2.2 \times 10^3$	$2.4 \times 10^4$	-	-
D	$2 \times 10^4$	$8.4 \times 10^2$	$<10$	$<30$	-	-
E	$8.2 \times 10^5$	$4.8 \times 10^3$	$1.5 \times 10^3$	$5.3 \times 10^2$	+	+
F	$8.3 \times 10^3$	80	$2.5 \times 10^4$	$1.3 \times 10^4$	-	-
G	$3.4 \times 10^4$	80	$2.7 \times 10^4$	$3.3 \times 10^2$	-	-
Average	$8.2 \times 10^4$	$8.3 \times 10^2$	$2.5 \times 10^4$	$2.3 \times 10^4$	36.5%	15.9%

<sup>a</sup> Average of duplicate replications, CFU/g=Colony forming unit per gram, Note: + unacceptable microbe quantities, - absence of microbe/ present but in acceptable amount

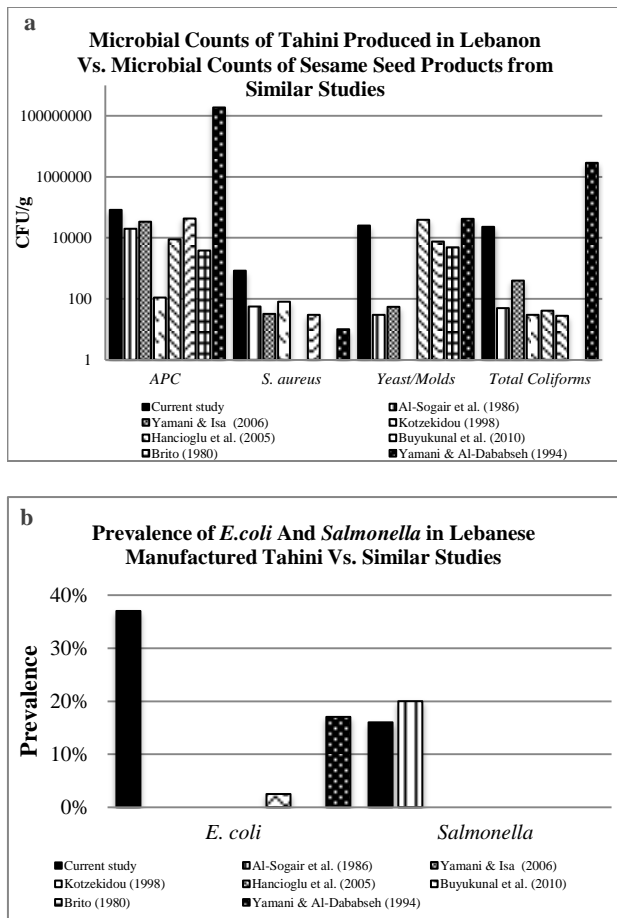

Figure 2. Microbial counts of tahini produced in Lebanon vs. Microbial counts of sesame seed products from similar studies. (a) APC, *S. aureus*, Yeast/mold, total coliform counts. (b) Prevalence of *E. coli* and *Salmonella*, CFU/g= Colony forming unit per gram. References [11], [19], [21],[22], [23], [24], [25] were used.

**B. Comparing Microbial Levels to Local and International Standards**

Lebanese standards set the maximum limit for APCs, yeast and molds, *E. coli* and *Salmonella* at  $1 \times 10^4$  CFU/g,  $1 \times 10^3$  CFU/g, 10 CFU/g, and 0 CFU/g respectively, beyond which microbial content could prove hazardous upon consumption [26]. As seen in Table II, a considerable amount of the samples analyzed contained unacceptable microbial content. Almost half of the samples, (46%) contained unacceptable quantities of APC, while more than half of the samples showed unacceptable quantities of *S. aureus* (52%), yeast and mold quantities (67%), and coliform counts (83%). *E. coli* was detected in 37% of the samples. Even minute amounts of *Salmonella* are detrimental to one's health and therefore 16% of the samples were found to be hazardous.

Standards available from the Gulf countries set the limit for APCs, *S. aureus*, and yeast and molds in tahini at  $10^7$ ,  $10^2$ , and  $10^3$  CFU/g [27]. Similar studies and other official institutions have also set acceptable standards for tahini and

ready-to-eat foods, as shown in Table III. According to Table III, the highest levels of acceptable microbial counts for APC, *S. aureus*, yeasts and molds, total coliforms, *E. coli* and *Salmonella* in CFU/g were as follows:  $10^7$  [27],  $10^4$  [28],  $<10^6$  [28],  $10^2$  [28][29],  $<10$  [26],  $<3$  [29].

TABLE II. COMPARISON OF MICROBIAL RESULTS WITH LOCAL STANDARDS

Micro-organism	Unacceptable Limits	Unacceptable Samples N	% Unacceptable
APC <sup>a</sup>	$1 \times 10^4$ CFU/g	29	46%
<i>S. aureus</i> <sup>b</sup>	$1 \times 10^2$ CFU/g	33	52%
Yeast and molds <sup>a</sup>	$1 \times 10^3$ CFU/g	42	67%
Total coliforms <sup>a</sup>	$1 \times 10^2$ CFU/g	52	83%
<i>E. coli</i> <sup>a</sup>	10 CFU/g	23	37%
<i>Salmonella</i> <sup>a</sup>	0 CFU/g	10	16%

<sup>a</sup> obtained from LIBNOR standards <sup>b</sup> obtained from GSO standards N= Number of Samples

TABLE III. COMPARISON OF LIBNOR STANDARDS WITH INTERNATIONAL STANDARDS

Microbial Standards	Microorganism CFU/g <sup>a</sup>					
	APC	<i>S. aureus</i>	Yeast/Molds	Coli-forms	<i>E. coli</i>	<i>Salmonella</i>
LIBNOR [26]	$10^4$	-----	$10^3$	$10^2$	$<10$	0
FDA [30]	$10^4$	-----	$10^3$	$10^2$	-----	0
Boderck et al., (1990) [29]	$<10^5$	$<20$	-----	$<10^2$	$<3$	$<3$
GSO [27]	$10^7$	$10^2$	$10^3$	-----	0	0
Health Protection Agency [28]	$10^6$	$10^4$	$<10^6$	$<10^2$	0	0
Buyukunal, et al. (2010) [24]	$10^5$	$10^2$	$10^4$	460	9	0
New Zealand Ministry of health [31]	$10^5$	$10^3$	-----	-----	0	0

<sup>a</sup> CFU/g Colony forming units per gram

When compared to those standards, the APC, *S. aureus*, and yeast and mold counts for all the examined samples in this study are considered acceptable. However, many samples would still remain unacceptable with regards to total coliform counts, and the presence of *E. coli* and *Salmonella*. None of the tested samples should contain *Salmonella* due to its characteristic as a health hazard. According to GSO standards, none of the samples should contain even traces of *E. coli* [27]. The remaining samples should contain microbial levels below the acceptable limits in order to indicate good



implementation of manufacturing procedures as well as safe product manufacturing.

C. Impact Factors

Furthermore, the samples were grouped according to their respective manufacturer, processing method, and storage time, in order to identify certain impact factors.

Impact by manufacturer. Table IV shows the results obtained when the samples were grouped according to the manufacturer (also refer to figures 3 & 4). This is determined by ANOVA analysis, with significance indicated by a 95% confidence interval. Significant differences were seen for *S. aureus* counts, yeast and molds, and for the presence of *Salmonella*. For *S. aureus* counts, companies F and C showed significantly higher levels of average counts compared to other manufacturers. Manufacturer C also showed significantly higher levels of yeast and molds. Meanwhile manufacturers D, and G showed no signs of *Salmonella*, compared to other companies and differed significantly from company E, which showed the highest prevalence of *Salmonella* in the tested samples. No significant differences were detected for APC, coliform, and *E. coli* counts. Therefore there seems to be slight differences in microbial quality depending on the manufacturer, as well as the microbe under investigation.

These results are consistent with a similar study that determined significant differences between samples of tahini produced by different manufacturers [11]. The variations in microbial levels could be due to different manufacturing procedures and processing parameters. For example, the temperature and time of roasting for one manufacturer may be more efficient for reducing microbial levels than the time and temperature implemented by a different company. Also, the source of sesame seeds and water may differ according to manufacturer, which may also depend on the place of production. Another factor could be the temperature of the facility. Companies that are located in areas with elevated heights usually experience lower temperatures than companies located in coastal areas. Therefore, processing and storage conditions that favor the growth of microbes may lead to the variations in microbial levels, which could drastically increase in hot, humid areas.

TABLE IV. AVERAGE MICROBIAL COUNTS OF TAHINI SAMPLES GROUPED BY MANUFACTURER

Manu- facturer	Microorganisms CFU/g					
	APC	<i>S. aureus</i>	Yeast/ Molds	Total Coli- forms	<i>E. coli</i> %	<i>Salmo- nella</i> %
A	1.9x10 <sup>4a</sup>	3.6x10 <sup>2a</sup>	1.2x10 <sup>4a</sup>	3.9x10 <sup>4a</sup>	33 <sup>a</sup>	11 <sup>ab</sup>
B	1.1x10 <sup>3a</sup>	2.7x10 <sup>2a</sup>	3.2x10 <sup>4a</sup>	3x10 <sup>4a</sup>	11 <sup>a</sup>	22 <sup>ab</sup>
C	1x10 <sup>3a</sup>	2.9x10 <sup>3b</sup>	7.3x10 <sup>4b</sup>	5x10 <sup>4a</sup>	44 <sup>a</sup>	22 <sup>ab</sup>
D	7.9x10 <sup>4a</sup>	2.1x10 <sup>3a</sup>	2.6x10 <sup>3a</sup>	1.9x10 <sup>4a</sup>	44 <sup>a</sup>	0 <sup>a</sup>
E	1.5x10 <sup>3a</sup>	6.9x10 <sup>2a</sup>	1.6x10 <sup>4a</sup>	1.7x10 <sup>4a</sup>	33 <sup>a</sup>	44 <sup>b</sup>
F	9.3x10 <sup>4a</sup>	1.3x10 <sup>3ab</sup>	2.7x10 <sup>4a</sup>	5.4x10 <sup>3a</sup>	44 <sup>a</sup>	11 <sup>ab</sup>
G	2x10 <sup>4a</sup>	73 <sup>a</sup>	1.3x10 <sup>4a</sup>	2.6x10 <sup>3a</sup>	44 <sup>a</sup>	0 <sup>a</sup>

\*Means within same row with different letters are significantly different (p≤0.05), CFU/g= Colony forming units per gram, Note: Nine samples were tested from each manufacturer

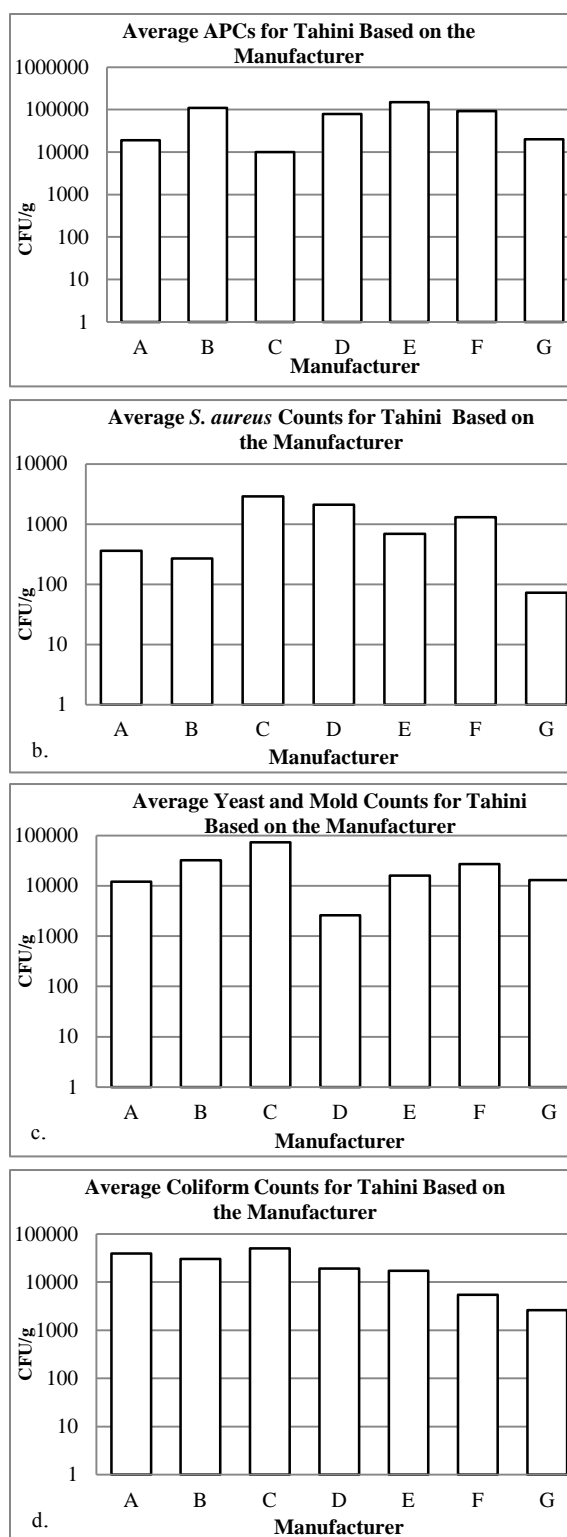

Figure 3. Average microbial counts in tahini samples according to the manufacturer (a) APC (b) *S. aureus* (c) Yeast/molds (d) Total coliform

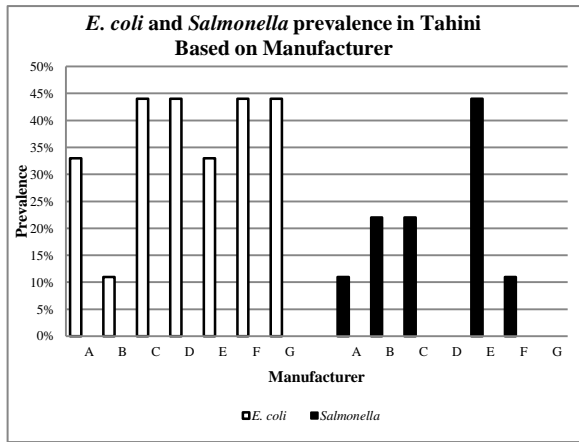

Figure 4. Prevalence of *E. coli* and *Salmonella* in tahini after grouping samples according to manufacturer

Another aspect may be the enforcement of HACCP plans and GMPs for production. Although the Lebanese government requires this, adherences to the regulations may be strictly enforced in one company yet loosely enforced in another. Whether or not the manufacturer produces tahini via the traditional or modern method may also play a role in determining levels of contamination as will be discussed.

**Impact of Processing Method.** The tahini samples were also grouped based on the processing method, i.e., whether the samples were produced via the traditional or modern method (solely automated machinery), and results were statistically interpreted based on a confidence interval of 95%. Significance was obtained via independent t-test analysis. Results are shown in Table V and Figures 5 & 6.

APCs were slightly higher for tahini produced by the modern method ( $9.2 \times 10^4$  CFU/g) in comparison to the average APC levels for tahini produced by the traditional method ( $2 \times 10^4$  CFU/g). The p-value for the differences was  $\leq 0.05$  and therefore it was significant. For average levels of *S. aureus*, tahini produced by the traditional method showed significantly lower counts (73 CFU/g) than tahini produced by the modern method ( $9.6 \times 10^2$  CFU/g). The p-value for *S. aureus* averages was also  $\leq 0.05$  and therefore the differences were significant. In the case of yeast and molds, the average for tahini produced by the modern method was slighter higher than the average for tahini produced by the traditional method. However, statistical analysis shows that this difference is not significant (Table V). Meanwhile, the average for total coliforms was  $2.6 \times 10^3$  CFU/g for traditionally produced tahini, and  $2.7 \times 10^4$  CFU/g for tahini produced by the modern method, with a p-value  $\leq 0.05$ , which signals significant differences. Meanwhile, although there appeared to be a somewhat recognizable difference in *E. coli* levels, statistical analysis indicates that there is no significant difference between both groups for *E. coli* counts ( $p > 0.05$ ).

Additionally, no *Salmonella* was detected in tahini produced via traditional methods. All the samples containing *Salmonella* were produced by the modern method and this difference was also significant ( $p \leq 0.05$ ).

Hence, it appears that the manufacturing of tahini via the modern “machinery” method is contributing to higher microbial levels in the products.

In a similar study however, tahini samples produced by the traditional method came out as more contaminated than samples produced by the automated method with regards to average APCs, and *S. aureus* counts [11], however the study’s results were consistent with our findings with regards to average counts for yeast and molds, which were higher for the modern manufacturing process.

TABLE V. AVERAGE MICROBIAL COUNTS OF TAHINI SAMPLES GROUPED BY PROCESSING METHOD

Microorganism CFU/g	Tahini Processing Method	
	Traditional	Modern
N	9	54
APC	$2 \times 10^{4a}$	$9.2 \times 10^{4b}$
<i>S. aureus</i>	73 <sup>a</sup>	$9.6 \times 10^{2b}$
Yeast & molds	$1.3 \times 10^{4a}$	$2.7 \times 10^{4a}$
Total coliforms	$2.6 \times 10^{3a}$	$2.7 \times 10^{4b}$
<i>E. coli</i> %	44 <sup>a</sup>	35 <sup>a</sup>
<i>Salmonella</i> %	0 <sup>a</sup>	19 <sup>b</sup>

\*Means within same row with different letters are significantly different ( $p < 0.05$ ), N= Number of samples, CFU/g=Colony forming unit per gram

It would have been expected that products obtained from traditional manufacturers contain higher levels of microbes, than products produced modernly due to a number of reasons including: lack of knowledge in HACCP principles, or the adherence to traditional production methods that may sometimes be unsanitary, as well as, the need to incorporate many staff members in small companies, which large manufacturing industries replace with machines. However, this was not the case in this study’s findings. Therefore, the reason behind the high microbial levels is most likely due to the source of water used in production, as well as the roasting time. The traditional manufacturer usually roasts the seeds until confident that the seeds are free from contamination, usually determined by certain indicators, such as the color, smell, etc. Roasting in a modern industry, however, is done via a machine with fixated time and temperature, and whether or not all the seeds have been roasted to the sufficient level, they will move along on the processing line and any microbial growth will remain. Furthermore, seeds that are stored in large industries are packed together in large amounts. This atmosphere increases chances for microbial growth specifically, yeast and mold. Another factor could be difficulty in accessing guidelines for standards, safety procedures, and GMP policies, which are not readily available in Lebanon.

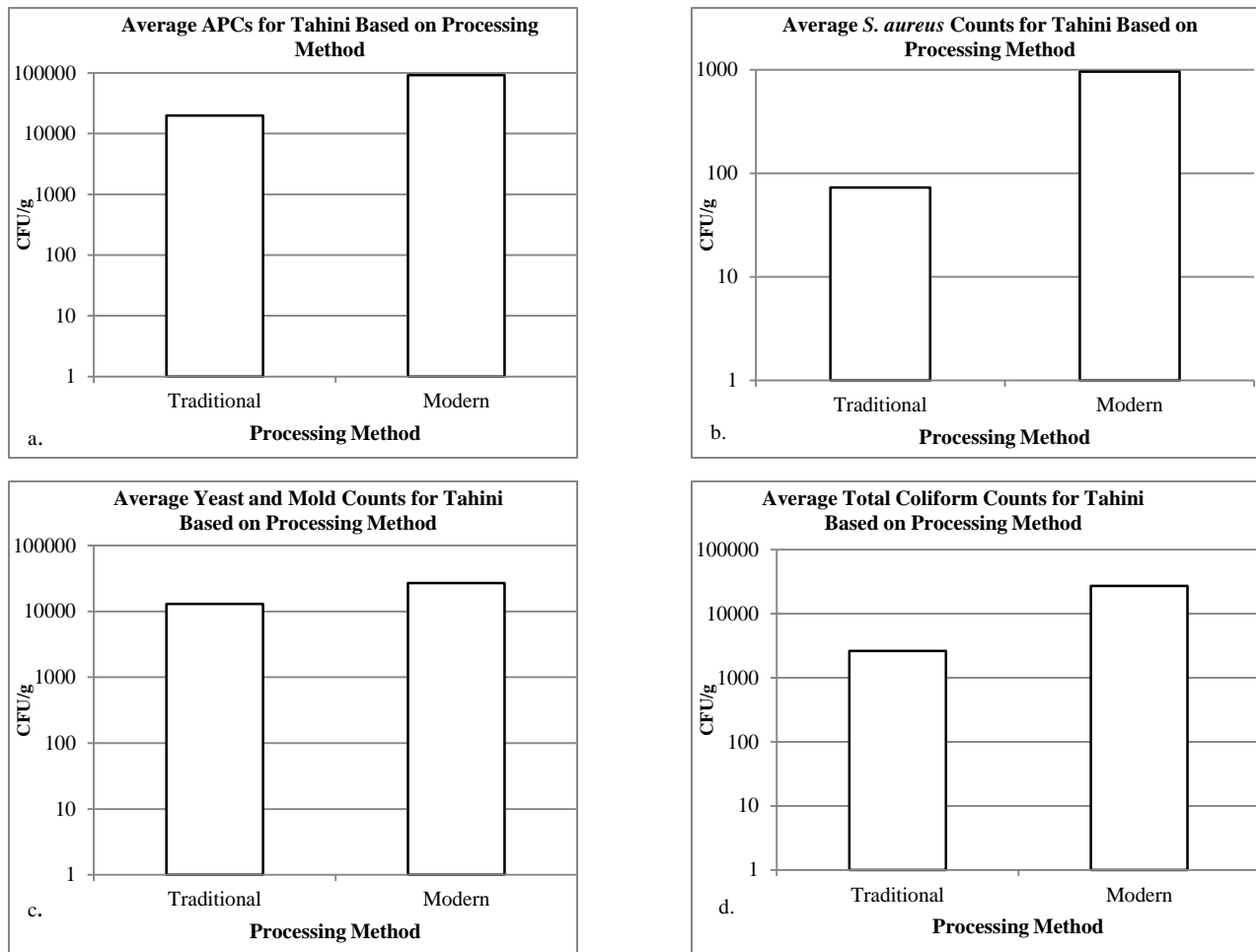

Figure 5. Average microbial counts for tahini based on processing method: (a) APC, (b) *S. aureus*, (c) Yeast and molds, (d) Total coliforms

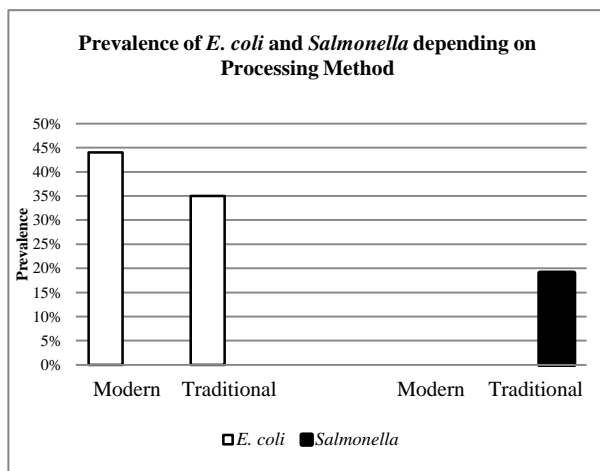

Figure 6. Prevalence of *E. coli* and *Salmonella* in tahini samples grouped according to sample age

**Impact of Storage Time.** The impact of the storage time was also assessed and the results of the statistical outcomes for the microbial counts are shown in Table VI (refer also to Figures 7&8). The samples were grouped based on whether the product was obtained directly from the manufacturer (fresh) or whether it spent a certain period of time (from 1 month to over 10 months) on the shelf. There were no significant differences among the samples with consideration for the sample age ( $p > 0.05$ ). Therefore the storage time seemed to have no significant impact on the microbial quality.

Although microbial counts were higher in products with a shelf life of over three months, products with shelf lives of over ten months showed sharp decreases in microbial quality. The fresh samples also appeared to have lower microbial qualities than older samples, yet similar to levels attained by samples over ten months.

In a similar study however, the microbial counts of tahini were seen to have significantly decreased after four months of storage [11]. The variations in our findings could be due to the fact it was not the same fresh sample but rather

samples from different batches that were examined, regardless of attribution to a same manufacturer.

TABLE VI. AVERAGE MICROBIAL COUNTS OF TAHINI SAMPLES GROUPED BY SAMPLE AGE

Sample age (Month/s)	N	Microorganisms CFU/g					
		APC	<i>S. aureus</i>	Yeast /Molds	Coli-forms	<i>E. coli</i> %	<i>Salmon-ella</i> %
Fresh	8	1.8x10 <sup>4</sup>	72	1.1x10 <sup>4</sup>	2.8x10 <sup>3</sup>	50	0
1	8	2x10 <sup>4</sup>	1.4x10 <sup>3</sup>	1.5x10 <sup>4</sup>	4.5x10 <sup>4</sup>	38	13
2	5	1.4x10 <sup>4</sup>	4.1x10 <sup>2</sup>	1.6x10 <sup>4</sup>	4x10 <sup>3</sup>	20	20
3	9	4.3x10 <sup>4</sup>	1.3x10 <sup>3</sup>	3.1x10 <sup>4</sup>	4.5x10 <sup>4</sup>	22	22
4	12	1.5x10 <sup>5</sup>	7.3x10 <sup>2</sup>	3.7x10 <sup>4</sup>	3.1x10 <sup>4</sup>	50	25
5	12	1.6x10 <sup>5</sup>	1.4x10 <sup>3</sup>	3.9x10 <sup>4</sup>	1.2x10 <sup>4</sup>	42	25
6-8	5	1.3x10 <sup>5</sup>	62	7.9x10 <sup>3</sup>	2.4x10 <sup>4</sup>	20	0
>10	4	5.8x10 <sup>3</sup>	4.2x10 <sup>2</sup>	1.4x10 <sup>4</sup>	7.9x10 <sup>3</sup>	25	0

Note: N=number of samples, CFU/g= Colony forming units per gram

Regardless however, it is evident that fresh samples and aged samples are vulnerable to microbial contamination. In addition, the results of the current study are uniform with results of similar studies that proved the existence of hazardous microbes in sesame paste products even after prolonged storage time.

Al-Holy et al. (2017) witnessed a decrease in *Salmonella* counts in halva with increased storage time [32]. The decrease in microbial levels could be due to bacterial competition for resources, which are limited in vacuum-sealed packages. However, even after a long period, the microbe was still present in hazardous levels, possibly due to the protective effect of high fat low moisture foods, for some bacteria [33][34]. Bacteria do not generally survive in dry environments, but some are able to survive in a dormant state, and when conditions are suitable once again, they are active, as is the case for *Salmonella*. Similar studies found that *Salmonella* survived in tahini even after 16 weeks of storage [35]. *Salmonella* was also seen to survive in tahini up to 8 months [36]. Meanwhile, Al-Holy et al. (2013) found that *E. coli* survived in tahini after 28 days of storage [37]. In halva, *S. aureus* was still present in the samples even after 9 months [23].

Tahini has a low water activity, and low water activity foods are considered safe from microbial contamination. However, this has not been the case. In the United States, 5,141 low-water activity food products were recalled from 2007 to 2012, due to bacterial pathogens [38]. Foodborne and waterborne pathogens can have deteriorative impacts on the quality of food, negative consequences to a person's health, and remain a major source for the spread of disease worldwide [40]. In general, contamination may occur from the use of contaminated water during washing, soaking, or brining, or cross contamination during processes that are open to air, for example, grinding or filling, or bad storage conditions within the factory [10].

On a more specific front, *S. aureus* often enter foods from the skin surfaces of employees [39]. The bacteria can be airborne and therefore exposure to the atmosphere for long periods of time can lead to high *S. aureus* counts.

Major health implications can result from high microbial counts of *S. aureus*, which can also include toxin production [40].

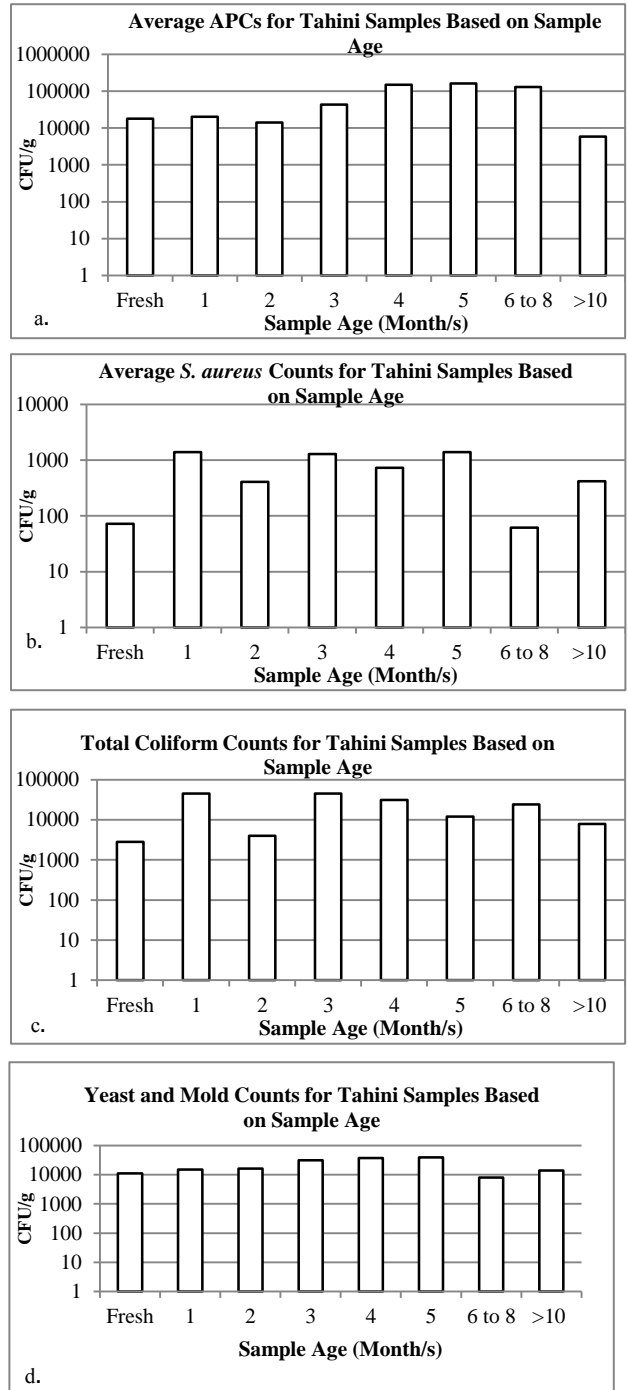

Figure 7. Average microbial counts in tahini samples grouped according to the sample age (a) APC, (b) *S. aureus*, (c) Yeast and molds, (d) Total coliforms

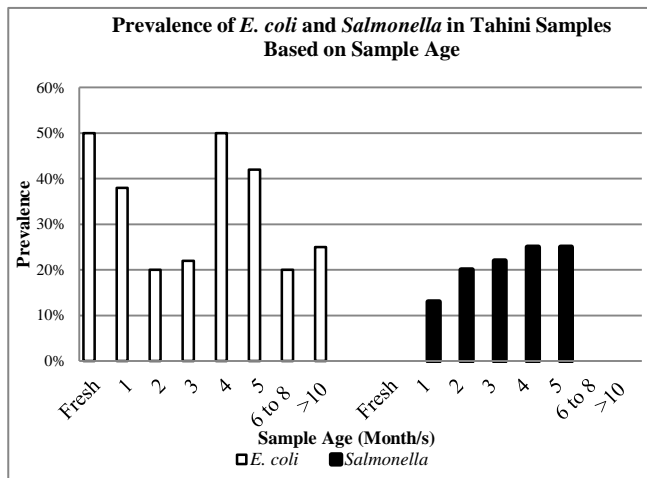

Figure 8. Prevalence of *E. coli* and *Salmonella* in tahini samples grouped according to sample age

Yeasts and molds are distributed widely in the environment as contaminants of air, water, soil and dust and present a potential threat due to mycotoxin production and allergic reactions [41]. During the study worms emerged on SDA agar, indicating the presence of insect eggs within the corresponding samples. Insect eggs can come as a result of improper handling and storage conditions and can also have negative implications to a person's health.

Coliforms on the other hand, principally *E. coli*, are widely used as indicators of human fecal contamination. Coliforms can cause gastrointestinal infections, and some strains of *E. coli* are also capable of causing serious kidney disease and can be fatal [39]. Presence of high coliform counts in food has been attributed to use of contaminated water during manufacturing [10]. Another microbe with fatal consequences upon ingestion is *Salmonella*. Various *Salmonella* species are commonly the etiological agents of salmonellosis, bacteremia, and typhoid fever, which require only minute amounts of *Salmonella typhi* [39]. The most commonly identified sources of *Salmonella* infections include birds and domestic fowl, including their eggs [39]. Contaminated water supplies and the handling of food products by individuals infected with this bacterium, could also lead to the spread of the microbe [10]. Insects, as well, are capable of transferring *Salmonella* upon ingestion or physical contact [42]. Inadequate roasting temperatures could lead to inadequate removal of *Salmonella* [10].

The obtained results indicate that some tahini produced in Lebanon is hazardous and could pose life-threatening consequences. In addition, about 35 percent of tahini produced in the country is exported, specifically to the USA, EU, Australia and the GCC. The products tested in this study include some of the country's major producers and exporters. The fact that Lebanese tahini has had incidents where *Salmonella* was detected, has reduced the quantities for export, especially to the USA [43]. Therefore the results indicate that Lebanese tahini could also have threatening consequences to health on a global scale, or to the country's

profits from tahini exports.

This is the first collective study in Lebanon that determines the quality of tahini produced in the country by studying the microbial quality of the products via conventional plating methods, while also considering the sample age as well as the processing methods as possible impact factors. Although the paper does only consider Lebanese products, it is worth noting that all the studied samples are from companies that export tahini worldwide, making the problem a global concern. Also, other major worldwide exporters (e.g., Turkish, Jordanian, and Saudi Arabian companies) also carried out similar studies on the microbial quality of tahini and other sesame paste products, in their respective countries [9][11][19], and hence, this study is to complement the others. Furthermore the discovery of contaminated tahini products in other countries, (Turkey, Jordan, and Saudi Arabia) [9][11][19] motivated us to test the quality of tahini in Lebanon.

#### IV. CONCLUSION

The results of this study provided an evaluation into the microbial quality of sixty-three tahini products manufactured in Lebanon and showed that some products are unacceptable in accordance to local and international standards. The results were also determined to be somewhat influenced by the manufacturer, to which each sample belonged to, the processing method used for production, as well as the time the sample spent on the shelf.

Limitations include unequal sample sizes for the different factors studied (sample age, processing method) due to limited resources, and the randomization procedure.

Further testing will be required to determine the source of contamination in order to contain it. Furthermore, the study could be a basis for further research aimed to eradicate high microbial counts in tahini without impacting the overall physiochemical quality. A number of recommendations are advised for the government, industry, and consumer.

It is recommended that tahini manufacturers, as should be the case with all food manufacturers of ready-to-eat foods, adhere to and strictly enforce Good Manufacturing Procedures (GMPs), and HACCP procedures, and amend regulations if need be the case.

It is also recommended that further inspection of tahini, as well as other sesame seed products be tested for microbial stability to ensure safe manufacturing of products.

It is also advised that food manufacturing facilities implement HACCP plans set by the government, and when violations of such plans due occur, it is advised that severe consequences are imposed. Furthermore, strict regulations should ensure that exported tahini meets the regulations of the target countries to prevent recalls. It is suggested that government standards, HACCP plans, safety procedures, and other regulations be readily available to the manufacturer in order to encourage and ease implementation of GMPs.

#### REFERENCES

- [1] Z. Alaouie, N. Hallal, A. Alkhatib, H. Khachfe, "Assessing the Microbial quality of tahini (Sesame Paste) in Lebanon," in

- The Sixth International Conference on Global Health Challenges*, Barcelona, 2017.
- [2] B. Ab-Jdayil, K. Al-Malah, H. Asoud, "Rheological Characterization of Milled Sesame (tahineh)," *Food Hydrocolloid*, vol. 16, pp: 5561, 2002.
  - [3] Future Market Insights, "Tahini Market: Middle East and Mediterranean Industry Analysis and Opportunity Assessment 2014 – 2020," Valley cottage, London, [Retrieved Online: July, 2017], Available from: <http://www.futuremarketinsights.com/reports/details/tahini-market>, 2015.
  - [4] M. Yamani and B. Al-Dababseh, "Microbial Quality of Houmas Commercially Produced in Jordan." *J. Food production*, vol. 57, pp. 431-435, 1994.
  - [5] H. A. Eissa and A. Zohair, "Quality and Safety of Halawa Modified with Mushroom," *Journal of Science and Food Agriculture*, Vol. 86, pp. 2551-2559, 2006.
  - [6] S. Birer, "The Production of Tahini Halva and Importance on Nutrition," *Gida*, Vol. 10, pp. 133-5, 1985.
  - [7] Blom Invest Bank, "The Lebanese Tahini and Halawa Production a Success Story Locally and Abroad," [Retrieved Online: July, 2017] Available from: <http://blog.blominvestbank.com/wp-content/uploads/2016/07/The-Lebanese-Tahini-and-Halawa-Production-A-Success-Story-Locally-and-Abroad-3.pdf> Beirut, Lebanon, 2016.
  - [8] World Health Organization, WHO Regional Office for the Eastern Mediterranean, "Hazard Analysis and Critical Control Point Generic Models for Some Traditional Foods: A Manual for the Eastern Mediterranean Region," Cairo, WHO EMRO publications, 2008.
  - [9] T. Kahraman, G. Issa, G. Ozmen, S. Buyukunal, "Microbiological and Chemical Quality of Tahini Halva" *British Food Journal*, vol.112, pp. 608 –616, 2010.
  - [10] United Nations Industrial Development Organization. "Food Series HACCP guidelines: Tahineh and Halaweh, Hazard Analysis Critical Control Point." Retrieved on June 2017 from: [https://www.unido.org/fileadmin/user\\_media/Publications/Pub\\_free/Tahineh\\_and\\_halaweh.Pdf](https://www.unido.org/fileadmin/user_media/Publications/Pub_free/Tahineh_and_halaweh.Pdf), UNIDO, 2003
  - [11] M. I. Yamani and J. K. Isa, "Microbiological Quality of Tehena and Development of a Generic HACCP Plan for its Production," *World Journal of Agricultural Sciences*, vol.2, pp. 290-7, 2006.
  - [12] International Commission on Microbiological Specifications for Foods, *Microbial Ecology of Foods*, Vol.1, Factors affecting life and death of microorganisms, London: Academic Press, pp: 70-110, 1980.
  - [13] Australian gov. Department of Agriculture, "Failing Food Report," Canberra city, Australian government, [Retrieved Online: July 2017], Retrieved from: <http://www.agriculture.gov.au/import/goods/food/inspection-compliance/failing-food-reports/2015/june-2015#risk--food-tests-targeted-monitoring-of-food-for-compliance-to-safety-standards>, 2015.
  - [14] R. D. Morton, F. P. Downes, K. Ito, "Aerobic plate count," *Compendium of Methods for the Microbiological Examination of Foods*, 4th edition. Washington, American Public Health Association, Chapter 6, pp. 63–67, 2001.
  - [15] British Standards Institution, BS5763, "Methods for Microbiological Examination of Food and Animal Feeding Stuffs. Part 7 - Enumeration of *Staphylococcus aureus* by Colony Count Method," London, BSI, 1983.
  - [16] Food and Drug Administration, FDA, *Bacteriological Analytical Manual*, 8th Edition, Revision A, Chapter 18, Association of Official Analytical Chemists, Official Method of Analysis, 15th ed., AOAC Arlington, VA., 1990.
  - [17] H. W. Gehm, and H. Heukelekian, "Eosin Methylene Blue Agar for Rapid Direct Count of *E. coli*," *American Journal of Public Health and the Nation's Health*, vol. 25, no. 8, pp. 920– 923, 1935.
  - [18] Food and Drug Administration, FDA, *Bacteriological Analytical Manual*, 8th Edition, Revision A, Chapter 4, Association of Official Analytical Chemists Official Methods of Analysis, 17th ed., Methods 967.25 -967.28, 978.24, 989.12, 991.13, 994.04, and 995.20. Gaithersburg, MD, 2000.
  - [19] M. Ayaz, W. N. Sawaya, and A. Al-Sogair "Microbiological Quality of Tehineh Manufactured in Saudi Arabia" *Journal of Food Protection*, Vol. 49, No. 7, pp. 504-506, July 1986.
  - [20] L. Unicomb, G. Simmons, T. Merritt, J. Gregory, C. Nicol, P. Jelfs,...C. Dalton(2005). *Sesame Seed Products Contaminated with Salmonella: Three Outbreaks Associated with Tahini*. *Epidemiology and Infection*, 133(6), 1065-1072. Doi:10.1017/S0950268805004085.
  - [21] I.Y.Sengun, O. Hancioglu, & M. Karapinar, "Microbiological Profile of Helva Sold at Retail Markets in Izmir City and the Survival of *Staphylococcus Aureus* in this Product." *Food Control*, 16, 840-844, 2005.
  - [22] O. J. Brito, "Usage of Sesame As a Source of Protein for Human Consumption." PhD. Thesis, University of Wisconsin, Madison, 1980.
  - [23] P. Kotzekidou, "Microbial Stability and Fate of *Salmonella* Enteritidis in Halva, a Low- Moisture Confection." *Journal of Food Protection*, 61, 181-185,1998.
  - [24] T. Kahraman, G. Issa, G. Ozmen, S. Buyukunal, "Microbiological and Chemical Quality of Tahini Halva." *British Food Journal*, 112(2), 608-616. Doi: <https://doi.org/10.1108/00070701011052691>, 2010.
  - [25] M. I. Yamani, and B. A. Al-Dababseh, "Microbial Quality of Hoummos (Chickpea Dip) Commercially Produced in Jordan." *Journal of Food Protection*, 57(5), pp. 431-435, 1994.
  - [26] Lebanese Standardization Institution. LIBNOR Standard number: NL 71 :2012 "Regional Standard for Tehena," Codex Stan 259-R-2007, 2012.
  - [27] GCC Standardization Organization. GSO standard number: 1016/2014 "Microbiological Criteria for Foodstuffs" Standard organization for G.C.C, pp.26, 2014.
  - [28] Health Protection Agency. (November, 2009). *Guidelines for Assessing the Microbiological Safety of Ready-to-Eat Foods*. London: Health Protection Agency. Retrieved online on August 2017 from: [https://www.gov.uk/government/uploads/system/uploads/attachment\\_data/file/363146/Guidelines\\_for\\_assessing\\_the\\_microbiological\\_safety\\_of\\_ready-to-eat\\_foods\\_on\\_the\\_market.pdf](https://www.gov.uk/government/uploads/system/uploads/attachment_data/file/363146/Guidelines_for_assessing_the_microbiological_safety_of_ready-to-eat_foods_on_the_market.pdf).
  - [29] M. Solberg, J. J. Buckalew, C. M. Chen, D. W. Shafiner, K. O'Neil, J. McDowell,..., M. Boderck, "Microbiological Safety Assurance System for Food Service Facilities." *Food Technology*, 44(12), 68-73,1990.
  - [30] Food and Drug Administration, "Guidelines for the Assessment of Microbiological Quality of Processed Foods," Phillipines: Department of Health, 2013.
  - [31] New Zealand Ministry of health. (October, 1995). *Microbiological Reference Criteria for Food*. Food administration Manual, Standards 11, 2, p.15
  - [32] A. Olaimat, A. Al-Nabulsi, T. Osaili, M. Al-Holy, M. Ayyash, G. Mehyar,..., M. Ghoush, "Survival and Inhibition of *Staphylococcus Aureus* in Commercial and Hydrated Tahini Using Acetic and Citric Acids." *Food Control*, 77, 179-186. Doi: 10.1016/j.foodcont.2017.02.022., 2017.

- [33] H. Li, H. Wang, J. Y. D'Aoust, J. Maurer, "Salmonella Species." In: M.P. Doyle, L.R. Beuchat, (eds.). *Food microbiology: Fundamentals and frontiers* (4th ed., Ch. 10 , pp:255-261). Washington D.C.: ASM Press, 2013.
- [34] Food Standards Australia New Zealand *Agents of Foodborne Illness*. 2<sup>nd</sup> ed., Canberra, Retrieved on July 2017 from: [http://www.foodstandards.gov.au/publications/Documents/FSANZ\\_FoodborneIllness\\_2013\\_WEB.pdf](http://www.foodstandards.gov.au/publications/Documents/FSANZ_FoodborneIllness_2013_WEB.pdf). 2013.
- [35] E. Torlak, D. Sert, & P. Serin. (2013). Fate of *Salmonella* during Sesame Seeds Roasting and Storage of Tahini. *International Journal of Food Microbiology*, 163, 214–217
- [36] A. A. Al-Nabulsi *et al.*, "Use of Acetic and Citric Acids to Control *Salmonella* Typhimurium in Tahini (Sesame Paste)." *Food Microbiology*, 42, 102–108, 2014.
- [37] A. A. Al-Nabulsi *et al.*, "Survival of *E. coli* O157:H7 and *Listeria innocua* in Tahini (Sesame Paste)." *Journal of Food Agriculture and Environment*, 11(3-4), 303–306, 2013.
- [38] United States Food and Drug Administration. (2012). Archive for Recalls, Market Withdrawals & Safety Alerts. Accessed November 2017 from: <http://www.fda.gov/Safety/Recalls/Archive/Recalls/default.htm>.
- [39] R. M. Atlas, "The Handbook of Microbiological Media for the Examination of Food." 2nd edition. Taylor and Francis Group, Boca Raton, FL, 2006.
- [40] Minnesota Department of Health. (2010). Causes and Symptoms of *Staphylococcus aureus*. Accessed online: <http://www.health.state.mn.us/divs/idepc/diseases/staph/staph.pdf>, Retrieved: November 2017.
- [41] B. Jarvis, D. A. L. Seiler, A. J. L. Ould, & A. P. Williams, "Observations on the Enumeration of Moulds in Food and Feeding Stuffs." *Journal of Applied Bacteriology*, 55, 325-36, 1983.
- [42] J. P. Soto-Arias, R. L. Groves, & J. D. Barak, "Transmission and Retention of *Salmonella* enterica by Phytophagous Hemipteran Insects." *Applied and Environmental Microbiology*, 80(17), 5447–5456. Retrieved on November 2017 from: <https://www.ncbi.nlm.nih.gov/pmc/articles/PMC4136094/>. Doi: 10.1128/AEM.01444-14, 2014.
- [43] US AID/Lebanon "Processed Foods Value Chain Assessment Report. Lebanon Industry Value Chain Development (LIVCD) Project," p:72-73, [Retrieved online: September, 2017], Available at: [http://pdf.usaid.gov/pdf\\_docs/PA00K5WW.pdf](http://pdf.usaid.gov/pdf_docs/PA00K5WW.pdf) February 2014.



## An Electronic Nose using a Protein-Biosensor and a Camera-Based Application

Noor Alrabeeah<sup>1</sup>, Omar Osman<sup>1</sup>, Ali Hage-Diab<sup>1,3</sup>, Houssein Hajj-Hassan<sup>2,3</sup>, Hassan M. Khachfe<sup>1,2,3</sup>, ✉

<sup>1</sup>Department of Biomedical Engineering

<sup>2</sup>Department of Biological & Chemical Sciences

<sup>3</sup>Lebanese Institute for Biomedical Research & Applications (*LIBRA*)

Lebanese International University

Beirut - Lebanon

{31230440, 11310051}@students.liu.edu.lb, {ali.hagediab, houssein.hajjhassan, hassan.khachfe}@liu.edu.lb

**Abstract** – Human’s olfactory system has a large number of receptors that respond only to a limited number of molecules. Since human noses are subject to fatigue, inconsistency and lack the sensitivity to low-concentration molecules, scientists have developed the Electronic nose (E-nose). E-nose is a device that identifies the specific components of volatiles and analyzes the chemical makeup to identify them. Regarding the applications of this device, they include, but not limited to, detection of odors specific to diseases for medical diagnosis and are used for the detection of gas leaks for environmental protection. An E-nose consists of both, a mechanism for chemical detection through an array of electronic sensors and mechanism for pattern recognition like that of the neural network. As for chemical detection and relating to the previous work of our fellow colleagues and major development of the E-nose by scientists at Tufts University, our E-nose developed here consists of a Biosensor, which is a protein extracted from animals and a labeling component that is a chemical dye that is suitable compatible to the protein used. As for the electronic part of the prototype that is responsible for the detection of color change of the dye during the interaction with the odors, it is made up of an application programmed for this specific purpose that ensures proper detection of RGB (red, green and blue) value color change. Several trials were, and will be, further performed to validate the interaction between Biosensors and odor samples, in both liquid and solid phases.

**Keywords** – E-nose; Volatiles; Biosensors; Chemical dye; RGB values

### I. INTRODUCTION

The olfactory system is one of the most intelligent sensory systems to be developed in the mother’s womb. The primary pathway consists of two components, the olfactory epithelium and the olfactory bulb. Olfaction means the sense of smell. The main organ involved in olfaction is the nose, which has millions of receptors for smelling that are present within olfactory epithelium. This epithelium has three kinds of cells: basal, supporting, and olfactory receptor cells [1][2]. Olfactory receptors are bipolar neurons that are made up of dendrites and an axon that ends at the olfactory bulb. The most important part of this receptor is the olfactory hairs that respond to chemicals that are breathed in. When odorants enter the nose, the olfactory hairs that are present inside the

nose become activated, generating the potential that then initiates the response [3]. Signals move from the olfactory cells to the olfactory bulb and move on to different parts of the brain, depending on what kind of signals.

Human sniffers are costly when compared to electronic noses. Electronic noses are quick and use reliable new technology of gas sensors. One major point is detection of hazardous or poisonous gas that is not possible with human sniffers that could be overcome by electronic devices.

Scientists thought of coming up with a device to overcome these complications. The solution to these difficulties would also advance the relationship between biology and technology. An e-nose is a device that identifies the specific components of an odor and analyzes its chemical makeup to identify it. Electronic noses have been around for several years but have typically been large and expensive. Current research is focused on making the devices smaller, less expensive, and more sensitive [4].

A next-generation artificial nose developed by Tufts neuroscientists [4] uses DNA (Deoxyribonucleic Acid) to detect odors, and possible applications range from medical, to commercial, and to defense. Researchers at Tufts have pioneered the use of DNA molecules to detect millions of odors. In early versions of the electronic nose, airborne odors passed over a square of silk screen treated with a mixture of a reactive polymer (a large molecule comprising a chain of smaller ones) and a fluorescent dye. If any property of the odor, its molecular shape, polarity or charge, interacted with the polymer, the fluorescent dye would glow in response. The trouble was, for each odor they wanted to detect, the researchers had to find, mainly through trial and error, the specific polymer that could serve as a sensor. Over 15 years, the Tufts team and researchers elsewhere discovered 20 to 30 polymers capable of detecting a handful of odors. Tuft’s University device where it could be tailored to be used in the food and beverage industry, ensuring high quality products and detecting possible contaminants [5].

As for the medical field, other researchers have come up with a device, later called Nano Artificial Nose (Na-Nose) [6]. In the absence of clear surrogate clinical markers that could discriminate between various sources of respiratory

infections, over-treatments with antibiotic prescriptions are evidenced in a large portion of the treated cases. There has been an increasing interest in recent years in improved methods for diagnosis of many metabolic and infectious diseases. These new methods are expected to be non-invasive and inexpensive, while allowing: (1) screening of high-risk populations for emerging diseases; (2) early detection and prediction of diseases; and (3) evaluation and monitoring of therapy efficacy.

A prototype of cross-sensitive nanowire-based sensors to be integrated in the 'Nano Artificial Nose' was trained to detect target disease related mixtures of biomarkers. Advanced development of the Nano Artificial Nose disease detection capabilities is present for the detection of the following indications (bacteria and other pathogens) from exhaled breath: Streptococcus; Methicillin resistant (MRSA); Staphylococcus; etc. Na-nose technology detects specific disease biomarkers based on a change in the blood chemistry or metabolic activity (which is reflected in the chemical composition of the exhaled breath and cell/tissue headspace) rather than by other forms of imaging or invasive blood analysis [6].

Relating to Tuft's University scientists' work, our prototype was initially intended to mimic the structure and functionality of the earlier projects. During experimentations, some modifications were performed that made way into what advancements in materials used in this project and composition of testing procedures along with the results.

The rest of the paper is structured as follows. Section II represents the materials used, the requirements and device design, the project working process and the methods used. Afterwards, in Section III, experiments, results and data analysis are described. Then, in Section IV, results are discussed and explained. Finally, in Section V, a conclusion summarizes the requirements of this project and enhancements that meet the market requirements.

## II. MATERIALS AND METHODS

E-Nose technology joins several analysis techniques that make way to understanding the structures and composition of odors. Figure 1 below shows the simplicity of the system; it is composed of the color sensor (middle), Arduino circuit (bottom) that acts as the brain of the system, and the required sample (upper images) to be tested. Following, Figure 2 illustrates the diagram of the device that consists of a chamber containing the fan and battery, biopolymer sensor, and odor receiving duct that is analyzed using a programmed application that recognizes the color change. Figure 3 describes the LIU (Lebanese International University) E-nose Application screens.

The following diagram describes the initial method of detecting change in color of the Biopolymer. It consists of the Arduino Uno microcontroller, which acts as the brain of the system and communicates between the color sensor and computer.

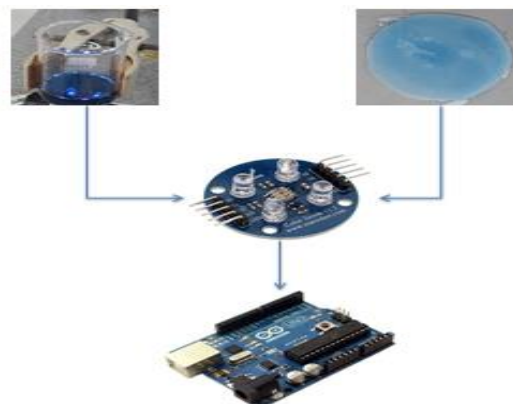

Figure 1. Color Sensor and Arduino Block Diagram.

The color sensor identifies the RGB spectrum of colors of the biopolymer, and then the results are visualized on the computer after being converted and processed by the Arduino. The experiment conducted is performed in both, the liquid and solid phase of the biopolymer.

This experiment was a proof of concept of the experiment done by Tufts University and the initial step of the upcoming experiments.

The diagram illustrated in Figure 2 describes the second and main method for detecting color change. The fan acts in drawing the odors from one part of the chamber with the least amount of turbulence towards the biopolymer sensor. After the biosensor and odor interact, change in color of the sensor composition is recorded by the phone camera. The phone flash light acts in transmitting visible light towards the sensor and the camera in receiving the light reflected. The data is analyzed and processed by an application programmed for this specific project. The application identifies the RGB spectrum, records the received data through an image taken, and saves the results in the phone library.

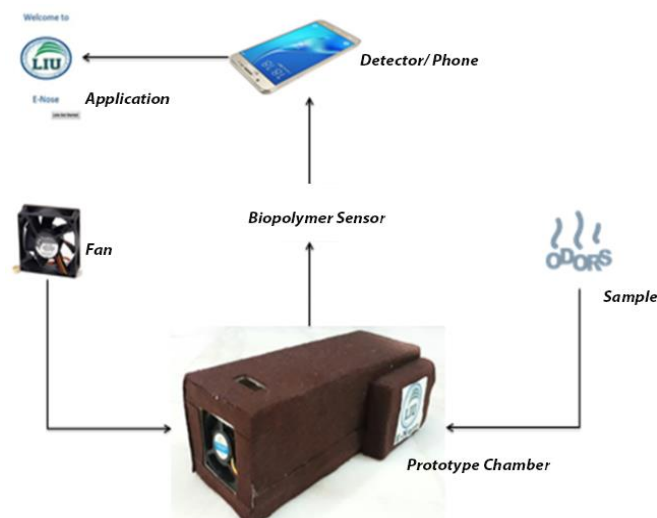

Figure 2. LIU (Lebanese International University) E-Nose Block Diagram.

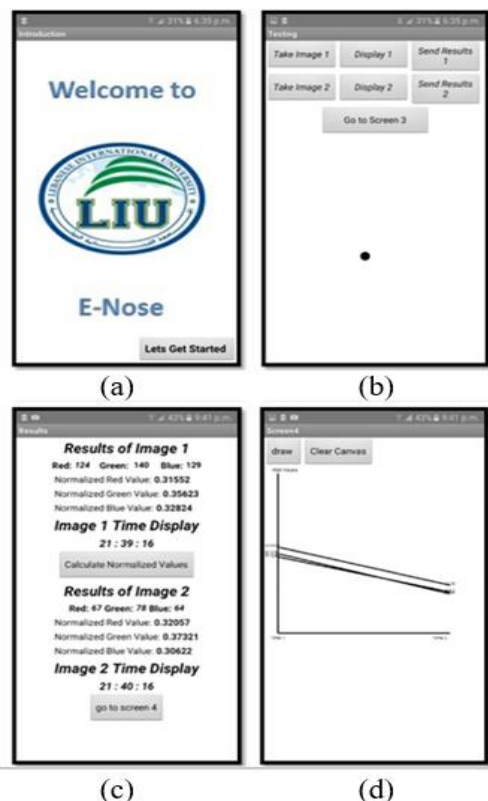

Figure 3. LIU E-Nose Application Stages: (a) Screen 1, (b) Screen 2, (c) Screen 3, (d) Screen 4.

Throughout the experiments performed on both methods, it was found more specific, accurate, and easier to choose the phone camera to identify and detect the color change.

The application is divided into four main screens. Screen 1 is the cover page of the application, which we can get started from. Screen 2 is the testing phase of the application. The user inputs the two images; the first one is that of the biosensor prior to interaction with the odor, then image two is taken after the fan draws the odor towards the biosensor and interacts with it. We display the images, one and two, and the ball is dragged to a pre-specified point that relates to the location of the biosensor in the chamber. The specified point relevant to the ball location is where the RGB values are extracted and are then saved. Then the results are sent to screen 3; the results screen. Each image taken on screen two has its RGB values saved here and displayed. In addition to the RGB values and normalized values, the time at which each image was taken is saved and displayed on this screen. Finally, in screen 4, a graphical diagram displays the change in RGB values before and after the interaction took place.

LIU E-nose application serves as the image processing software programmed using MIT (Massachusetts Institute of Technology) App inventor [7]. The software makes use of a typical phone with 13-megapixel rear autofocus, a wide aperture for extra light reaching image sensor, and an LED (light emitting diodes) flash. Software attains RGB values at

fixed distance from the samples as well as exact focused point in all the tubes to minimize light differences and have more precise results.

#### A. Proteins

One major factor that describes these chosen proteins is their amphipathicity. Amphipathicity describes the surfaces on a protein, particularly the alpha helix, which mean that one surface of the alpha helix has hydrophilic amino acids while the opposite face has hydrophobic (or lipophilic) amino acids.

Bovine Serum albumin (BSA) is the most abundant plasma protein in mammals. SA is a multifunctional protein with extraordinary ligand binding capacity. Albumins exhibit a high degree of cross-reactivity due to significant sequence and structure similarity of SAs from different organisms [8].

LDH (Lactate Dehydrogenase) is an enzyme found in nearly all living cells and is composed of four subunits (tetramer). LDH in humans uses His(193) as the proton acceptor, and works in unison with a coenzyme, and substrate binding residues [11]. The His(193) active site, is not only found in the human form of LDH, but is found in many different animals, showing the convergent evolution of LDH. A dehydrogenase is an enzyme that transfers a hydride from one molecule to another [9].

ALP (Alkaline phosphatase), from bovine intestinal mucosa, is most stable in the pH range 7.5-9.5. The enzyme has a broad specificity for phosphate esters of alcohols, amines, pyrophosphate, and phenols and it requires zinc, and magnesium or calcium divalent ions for activity. These characteristics give rise for the stability and structure suitable for the project's main application [10].

#### B. Dye

In this experiment, it is required to monitor color change. This factor is not present for the protein alone but requires an additional color label that facilitates monitoring this change. The label used here is the coomassie blue dye that is used to glow after an interaction between the biopolymer and certain odors takes place. The coomassie is the most suitable and commercially available colorant for this experiment.

#### C. Organic Oils:

To limit the specificity of the odors used in this experiment, we used three types of odors that are: a) widely abundant in all homes, b) cheap and available, and c) are considered essential oils that minimize the quantity of these oils used. In the beginning of the experiments, coconut and rose water oils are used, but since they have certain limitations, (high viscosity of coconut oil, rose water being non-colorless) those factors influenced false results. To avoid these aspects, we used tea tree oil that is colorless, has low viscosity like that of water's, and has concentrated scents.

### III. PREPARATION STEPS

#### A. Experiment 1: LDH – Coomassie using LIU E-Nose Application:

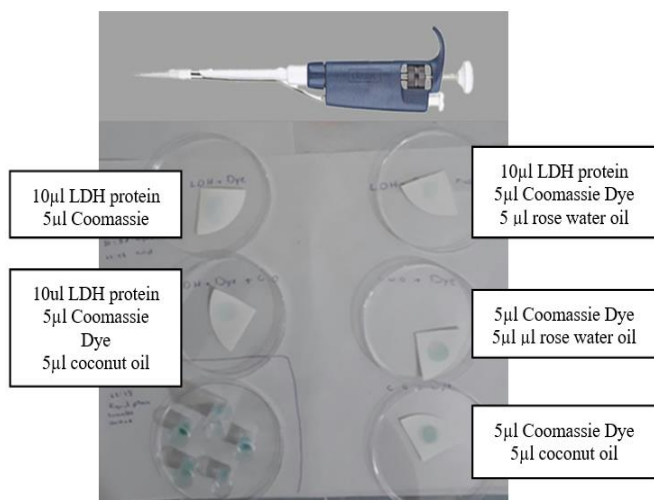

Figure 4. LDH - Coomassie - Oils (liquid and solid) Preparation.

#### B. Experiment 2: ALP – Coomassie Solid State against Exhaled Volatiles

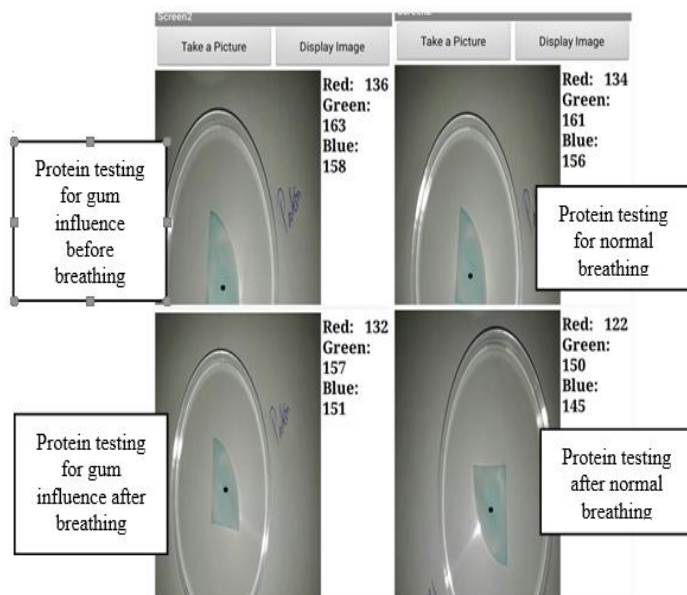

Figure 5. ALP vs Exhaled Volatiles in Solid Phase.

In this experiment, a different approach was followed. Using the same procedure as the ones studied earlier, but without adding the organic oils to the samples, instead the Whatman papers only contained 5g/l concentration of ALP protein and 5 ul dye volume.

The odors now used are human breaths. The approach here was to monitor the change in color of the protein-dye mixture due to their interaction with chemical gases exhaled from a certain individual. Prior to any exhale, the color of

the paper was recorded and noted down. Then, at one hand, the individual was asked to exhale with ordinary breath and noted down the difference in the color as shown in Figure 5, right column. On the other hand, the same patient was asked to chew a gum for 3 min then exhale with the same pressure and volume as that of the first trial and recorded the results afterwards.

The two trials showed positive results to the interaction between the protein and the exhaled gases. Additional experiments were held using the prototype and the LIU E-Nose application to validate the previous results.

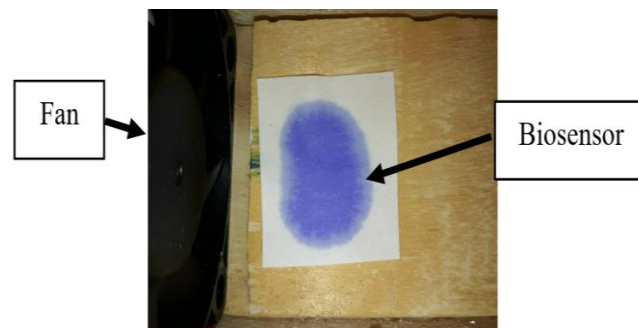

Figure 6. ALP and Coomassie Blue Dye in the Chamber.

The biosensor was situated in the specified location on the biosensor-odor slider inside the chamber, as shown in Figure 6. Using the application, the first image was taken before any interaction with the biosensor and then the second image was taken after an individual exhaled on the biosensor; knowing that the same person was chosen to perform both previous experiments; data was received and saved by the application.

#### C. Experiment 3: ALP – Coomassie Interaction with Tea Tree Oil in Liquid Phase

- 1) Use an Analytical Balance to weigh 3.5mg of ALP (alkaline phosphatase) protein
- 2) Dilute with 0.67ml distilled water at 33°C to obtain 5.2g/l concentration
- 3) Take 10ul prepared ALP and add to it 5ul coomassie dye and 5ul tea tree oil and pour in 1.5ml eppendorf tubes
- 4) Prepare reference tubes containing:
  - a) 10ul ALP protein with 5ul coomassie dye (control tube)
  - b) 5ul coomassie dye with 5ul tea tree oil
  - c) 5ul coomassie dye
- 5) Mix the combinations for 2 min using a vortex mixer
- 6) Place the sampled tubes in a water bath at 33°C for 30 min
- 7) Record the change in color at the end of the experiment, each tube with respect to the reference tube containing the protein-dye mixture, using the phone camera
- 8) Analyze and compare the results using the LIU E-Nose application



#### IV. RESULTS

Combining the previous installments and procedures, several experiments were performed to identify and allocate the appropriate combination of ingredients. And in order to assess the most suitable experiment, comparison was performed between the different proteins, odors, and even phases of mixtures. Different proteins give rise to which is most suitable to use. From different odors, we can clear out some artifacts and specify which has the least effect on other components. Whereas from different phases, liquid or solid, we can somehow reach a state of testing very similar to how the natural nose works.

##### A. Experiment 1 results:

###### 1) Results in liquid phase:

Using a 5-50  $\mu$ l pipette, prepare the previous mixtures with the values of each paper listed beside it; noting that the liquid prepared solutions are the same as those of the solid phase ones.

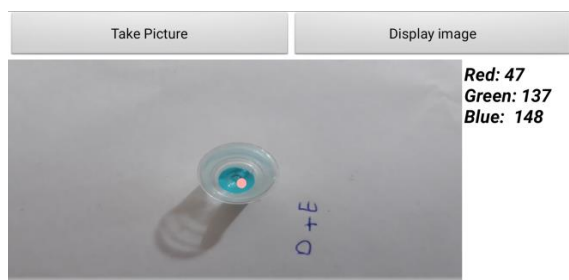

Figure 8. Testing in liquid phase (LDH protein + Coomassie Blue Dye).

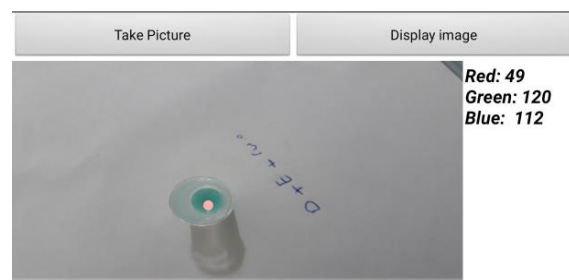

Figure 7. Testing in liquid phase (LDH + Dye+ Rose Water).

As for the LDH protein and dye, it is the main biosensor through which results of the other added odors are compared. The lighter mixture, rose water, that is added to the previous biopolymer mixture, shows different RGB values, both visualized by the application as well as the naked eye. These results give rise to verifying the different interactions between the protein-dye mixture and different odors. But what if the change in color was due to the oil interacting with the dye? The previous question is answered through taking other prepared dye samples and adding the oils to them. The results of these two different samples are visualized while comparing Figures 7 and 8.

Figure 9 shows that the interactions between the dye and organic samples are different than those with the protein-dye mixture. This verifies that the original color of oils factor is well studied, and error possibility is significantly minimized that allows studying the interaction between the protein-dye mixtures with added organic oils.



Figure 9. Rose Water Oil + Dye in Liquid Phase.

###### 2) Results in solid phase:

Another experiment was conducted in the dried-up phase of the protein and dye on Whatman paper. The procedure is described as adding the given quantity of protein onto the paper, then dropping the quantity of dye onto the protein. Following, the organic oils are finally added to the previous mixture.

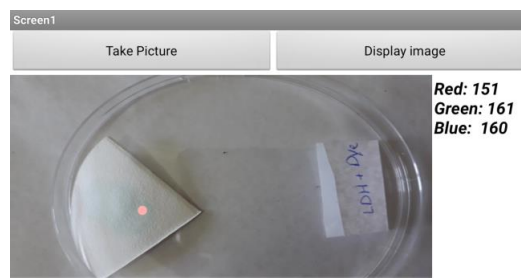

Figure 10. LDH + Dye in Solid Phase.



Figure 11. LDH + Dye + Rose Water.

Consider the previous preparations in Figures 10 and 11, having the same volume and concentration of the protein and dye, oil added after a period of 5 min shows different recorded RGB values between the two. Whereas, when adding different organic oils, each composition reacts in a specific manner with respect to the oil used.

B. Experiment 2 results:

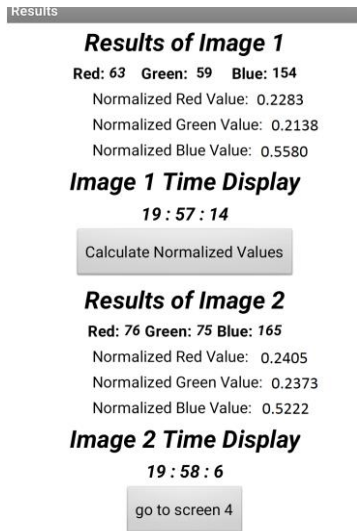

Figure 12. RGB Values before and after the Exhaled Gases.

As shown in Figure 12, the results screen from the application, the trials showed positive outcome to the interaction between the biosensor and the exhaled gases. In the following graphical diagram of Figure 13, we can visualize the change in color as enlisted in the results screen previously.

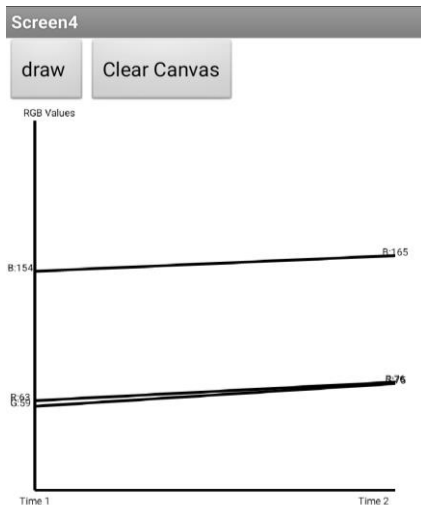

Figure 13. Graphical Diagram Displays the Change in RGB Values before and after the Interaction.

In this experiment, the same preparation steps, conditions and materials of that of the previous experiment were used. The approach was to perform the test 30 times on the same biosensor and by the same given individual. After every trial, the setup was flushed by a reference gas in order to return the RGB values to the baseline. Following that, a period of 2 minutes was taken (recovery period) to make sure the biosensor returns to the initial state (baseline) before the interaction with the odors.

TABLE I. STATISTICS OF EXPERIMENT PERFORMED 30 TIMES.

	before exhale			after exhale		
	Red	Green	Blue	Red	Green	Blue
Trial 1	63	59	154	76	75	165
Trial 2	62	58	154	73	72	164
Trial 3	62	58	156	72	71	165
Trial 4	63	57	153	75	69	162
Trial 5	64	58	153	77	70	163
Trial 6	64	59	152	78	73	160
⋮	⋮	⋮	⋮	⋮	⋮	⋮
Trial 25	62	60	152	71	76	166
Trial 26	63	57	154	75	74	164
Trial 27	65	58	153	74	73	162
Trial 28	63	58	154	76	75	167
Trial 29	64	59	155	70	76	170
Trial 30	63	59	154	71	72	168
<b>Average</b>	63.16667	58.33333	153.6667	74	73	164.6667
<b>Mean Average</b>	63	58	154	74	73	165
<b>% error</b>	4.761905	5.172414	2.597403	10.81081	8.219178	6.060606
<b>STD</b>	0.897527	0.849837	1.105542	2.483277	2.198484	2.687419

Pre-exhalation:

Repeatability of RGB values before exhalation was consistent with an error of less than or equal to 5% → this validates that:

- the baseline of RGB values was maintained after each exhalation
- the odors absorbed by the proteins are rid due to flushing reference gas for a recovery time of 2 minutes

Post-exhalation:

Error percentage was too high since breathing wasn't consistent (pressure, volume, temperature, and pH of exhaled breath) were not the same in all exhalations.

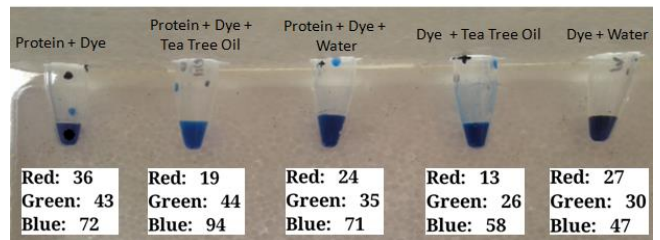

Figure 14. RGB Values of the Prepared Samples in Liquid Phase.

C. Experiment 3 results:

Figure 14 shows the different results obtained from the experiment at the same time. It shows the prepared samples with a label with its content above each tube, while the RGB values are listed below the tubes. Detailed explanation of the results is further mentioned in the discussion.

We keep the following conditions of the samples constant:

- Temperature using water bath
- pH levels using ALP; stable pH
- Volume and concentrations using pipettes, balance, and dilution factor

We used alkaline phosphatase as the protein due to its key features:

- 4 hydrophobic pockets are necessary to interact with the acquired odors
- Stable pH levels reduce odors' pH influence
- Temperature stability (up to 80 degrees) [11].

We choose tube 1 to the left as the reference and control to compare the color change of the rest of the tubes to it. Following is the protein and dye interacting with tea tree oil, transparent and low viscosity organic oil with a specific chemical structure.

To eliminate the effect of dilution that might be the reason of the lighter blue color of the sample, we add in the 3<sup>rd</sup> tube the same volume of the tea tree oil same as that of tube 2 and notice that there is difference in color as compared to the mixture with the organic oil. Thus, another factor is studied, and this showed positive results.

In the following tubes, 4 and 5, we tested for the interaction between the organic oils and dye. It is required to validate that the interaction is with the protein and not the dye. Comparing the results of the tube 4 to tube 2, and tube 5 to tube 3, the dye did not quite change its color, which made us conclude that there is minimal interaction between the oils and dye.

#### V. RELATED WORK

Recent advances demonstrate that proteins, ORs (olfactory receptors) or OBPs (odorant-binding proteins), can be employed as molecular recognition units in gas-phase biosensors. The interactions between odorant molecules and these proteins are a source of inspiration for designing peptides with tunable odorant selectivity [12].

Peptides represent a simple and low-cost option for biosensors that can be biologically or synthetically produced. Initially, OBP biosensors were tested against volatiles and odor solutions, with measurements of analytes in gas phase only reported by the end of the 2000s. These peptides are considered easier to place and stabilize on sensor surfaces than ORs [12].

Some methods for testing of VOC (Volatile Organic Compounds) were used. Each had a certain significance in respect to the peptides used as biosensors. The following table, Table II, summarizes the strategy used, from relevant biosensor to the equivalent VOC and the type of transducer specific for this method. Each testing group had specific support; each had a specific-to-biosensor material to be mounted on.

The different methodologies mentioned in the following table are relevant to the different techniques of testing VOCs throughout the years of advancements of volatiles' identification.

TABLE II: BIOSENSORS AND TRANSDUCERS FOR A SPECIFIC VOC

Protein	Protein Origin	Transducer	VOC	Support	Reference
pOBP	Pig OBP	Si-substrate with interdigitated electrodes (EIS)	Ethanol; methanol	Silicon	[13]
AaegOBP22	Mosquito Aedes aegypti	ZnO film bulk acoustic resonators (FBAR)	N,N-diethyl-meta-tolamide (DEET)	Gold	[14]
mOR174-9	Mouse OR	CNT (carbon nanotubes) transistors, Current-gate Voltage	Acetophenone, Others	Carbon Nano-Tubes	[15]
NQLSNLSF (dORp61)	Dogs OR	Piezoelectric multiarray analyzer	Trimethylamine (TMA); ammonia; acetic acid; ethyl acetate; methanol	Gold Surface	[16]

Following are some explanations to the different transducers used above:

- Dielectric spectroscopy measures the dielectric properties of a medium as a function of frequency. It is based on the interaction of an external field with the electric permittivity of the sample [17].
- A thin-film bulk acoustic resonator (FBAR) is a device consisting of a piezoelectric material sandwiched between two electrodes and acoustically isolated from the surrounding medium [18].
- A carbon nanotube field-effect transistor (CNT) refers to a field-effect transistor that utilizes a single or array of carbon nanotubes as the channel material instead of bulk silicon structure [19].
- A piezoelectric sensor is a device that uses the piezoelectric effect to measure changes in pressure, acceleration, temperature, strain, or force. Then these factors are converted to electrical signals for identification [20].

Using biological recognition units such as insect/ animal-based proteins in sensing devices improves their selectivity and sensitivity towards defined targets, with proven pronounced expression in samples analyzed in liquid states. The behavior of these biosensors in testing analytes in the gas phase is also recommended to attempt and compare. Means of mimicking the actual olfactory system functionality gives rise to complementing real-life scenarios.

Based on the techniques discussed in similar projects, there are several challenges present that inspire future developments. These challenges may include drawbacks of low stability and high promiscuity towards VOC molecules, resulting in low selectivity. The difficult, expensive, and time-consuming handling of membrane proteins may have led to the pursuit of simpler and more robust biomolecules as recognition agents; therefore, gas-sensing biosensors based on the soluble proteins [21].



Some similarities in application were found in the technology used in the previous experiments while being compared to the project under study.

A) OR response to VOCs may be distorted due to the presence of the lipidic fraction of the membrane such as phospholipids. LIU e-nose proteins used act in binding odors to the phospholipids of proteins used.

B) OBPs can withstand high temperatures before experiencing denaturation, and after unfolding they frequently refold, restoring their initial structure. Stability of pOBP increases at higher temperatures [22]. Researchers used animal proteins to test for the affinity of interaction between biosensors and volatiles and studied their influence while relating to different temperatures. On the other hand, our project used alkaline phosphatase protein that incorporates temperature stability prior to and after interaction with volatiles.

C) A detailed analysis of the VOC-binding pocket from OBPs was tested, even though the target VOC is different. Here, testing included the study of binding pockets from OBPs while ours discusses the pockets of ALP structure and their interaction with and immersing of VOCs at the site of structural pockets.

Over the last 5 years, there has been an increase in OBP- and peptide-based biosensors. Certainly, using membrane protein receptors as ORs is more challenging, expensive, and time consuming, when compared with soluble and robust proteins such as OBPs. An investment in the expansion of tested VOCs for the development of gas biosensors is required, as recent examples report a very limited number and chemical diversity of VOC targets.

## VI. DISCUSSION

Electronic noses were originally used for quality control applications in the food, beverage and cosmetic industries. Current applications include detection of odors specific to diseases for medical diagnosis, and detection of gas leaks for environmental protection [23].

The advancement of e-noses may be coupled with different sensor technologies, such as optical sensors, conductive polymers, and in our case biopolymers.

Initiating our analysis, a color sensor is used, combined with an arduino that controls and acquires data received by the sensor. First experiments showed detection of color change of the RGB values while stabilizing surrounding conditions to prevent artifacts from influencing our results. Yet, after maintaining constant light, temperature, and sample settings, inadequate results were obtained. Any little light disruptions, as well as inappropriate distance of sensor from samples caused false results. In addition, reflections off objects placed in the surroundings, either sample or sensor, did have a wrong impact on the results. Thus, another detection method is to be used after several trials performed earlier. CCD (charge-coupled device) camera is considered more convenient than the color sensor due to its

high efficiency, as well as the broad availability of this sensor. Combined with a microcontroller or analyzing unit, this arrangement makes way to detecting the RGB value changes more accurately than that of the color sensor, as well as proper analysis of the results.

It is validated that DNA interacts with odors as mentioned in Tuft's University experiments. The experiments conducted here are through using proteins as biopolymers instead of DNA. It is known that protein normally binds lipids. Most odors are hydrophobic that make them candidates to bind to the hydrophobic pockets available in the protein structures used here [24].

The specific influences of conditions that might affect the interaction of the protein with the samples are avoided. Temperature is maintained constant at 37 degrees, using a water bath. The first experiments included the use of LDH and BSA proteins. Several trials were conducted on these proteins. In addition, to prevent any pH fluctuations, ALP is used instead of the previous proteins for its high affinity to bind lipids without changing pH levels. Setting pH at a specific value is required, for we are not probing the change in pH, but we shall see odor sensitivity.

In order to visualize color change, a labeling substance is used. The marker used here is the coomassie blue dye. To detect the color change after an interaction between the biopolymer and certain odors, the dye fluoresces and changes its degree that facilitates the visualization of the interaction occurring between the protein and volatiles. The coomassie blue dye associates with basic and aromatic amino acids, thereby causing shift in absorbance during protein determination [25].

The volatiles used in this experiment are coconut oil, rose water oil, cloves oil and tea tree oil. Coconut oil has high viscosity that prevented proper mixing with proteins. Rose water and cloves oils already have a non-transparent color thus they will affect the RGB values analysis. We used the tea tree oil, a transparent, low viscosity, and essential organic oil with a specific chemical structure is then used.

Binding of hydrophobic entities like odors may induce structural changes to protein due to the presence of hydrophobic pockets that may change their optical characteristics. Such interaction with lipids will induce structural changes down to the helical structure of proteins (Angstroms measurement unit) that affect their color nature, e.g.: globin proteins that change color from dark red to light violet based on structural change; cytochromes, hemoglobin, etc.

Optical activity of substance changes based on its modification in structure impacts transparency vs. opacity as well as color vs. color change.

The detected difference of the RGB values can be visualized both using the naked eye, as well as by using the application. The application uses the camera that is set to measure RGB values so there is no need for any pre-processing.

## VII. CONCLUSION

As a conclusion, the focus of this project is to mimic the functionality of the olfactory system using materials available in every lab. This makes way to producing a cost-effective and easy to use device to perform the necessary function. The experiments were performed on similar materials as that of Tuft's University then deviated the attention onto using, proteins instead of DNA, as the sensors for odor identification. It was validated that each gaseous and liquid phased molecules and odors interact differently when in contact with different proteins. This variance is used to check for better repeatability, sensitivity, and stability. This is analyzed by using a developed LIU E-nose application that records and displays the values of change in color post protein-odor interaction. Further practice shall lead to a better understanding of the specific interaction with given odors that can lead to notable discoveries in the field of diseases' testing and identification as well as in other daily-life fields.

Current research is focused on making the devices smaller, less expensive, and more sensitive. The previously mentioned are crucial factors to the analysis and odor identification. The smaller the device, the more user friendly it is. Being more affordable increases the number of users, as well as ensures better testing of daily-life products, and more importantly better disease identification. Thus, further practice shall lead to a better understanding of the specific interaction with given odors that can lead to notable discoveries in the field of diseases' testing and identification as well as in other daily-life fields. The possibilities are almost endless.

## REFERENCES

- [1] N. Alrabeeah, O. Osman, A. Hage-Diab, H. Hajj-Hassan, and H. Khachfe, "A Cost-Efficient, Camera-Based Electronic Nose," The Sixth International Conference on Global Health Challenges (GHC 2017) IARIA, ISBN: 978-1-61208-604-0, Nov. 2017.
- [2] A. Vokshoor, F. Talavera, S. Batuello, and A. Meyers, "Olfactory System Anatomy," September 5, 2013.
- [3] A. Menini, "The neurobiology of olfaction," editor Boca Raton (FL): CRC Press/Taylor & Francis; 2010.
- [4] S. Chen, Y. Wang, and S. Choi, "Applications and Technology of Electronic Nose for Clinical Diagnosis," Open Journal of Applied Biosensor, pp. 39-50, 2013.
- [5] J. Mitchell, "Picking up the scent," Tufts Journal, August 2008.
- [6] NoCamels Team, "NaNose: The Breathalyzer Test That Sniffs Out Lung Cancer Before It," June 19, 2014.
- [7] H. Abelson, "Massachusetts Institute of Technology Application Inventor," (2012-2017).
- [8] K. Majorek, P. Porebski, M. Chruszcz, S. Almo, and W. Minor, "Crystal structure of Bovine Serum Albumin," New York Structural Genomics Research Consortium, January 4, 2012.
- [9] RS. Holmes, E. Goldberg, "Computational analyses of mammalian lactate dehydrogenases: human, mouse, opossum and platypus LDHs," Computational Biology and Chemistry. 33 (5): pp. 379-385, October, 2009.
- [10] Kim EE, Wyckoff HW, "Reaction mechanism of alkaline phosphatase based on crystal structures. Two-metal ion catalysis," Journal of Molecular Biology. 218 (2): pp.449-464. doi : 10.1016/0022-2836(91)90724-K. PMID 2010919, March 1991.
- [11] L. Zhang, R. Buchet, and G. Azzar, Biophys j, "Phosphate Binding in the Active Site of Alkaline Phosphatase and the Interactions of 2-Nitrosoacetophenone with Alkaline Phosphatase - Induced Small Structural Changes," pp: 3873-3881, 2014.
- [12] G. Arménio, J.M.Barbosa, R. Oliveira, and C.A.Roque, "Protein- and Peptide-Based Biosensors in Artificial Olfaction," Trends in Biotechnology, Volume 36, Issue 12, pp. 1244-1258, December 2018.
- [13] S. Capone, "Electrical characterization of a pig odorant binding protein by impedance spectroscopy," Proc. IEEE Sens., 2009, pp. 1758-1762, 2009.
- [14] X. Zhao, "Protein functionalized ZnO thin film bulk acoustic resonator as an odorant biosensor," Sens. Actuators B Chem., 163, pp. 242-246, 2012.
- [15] B.R. Goldsmith, "Biomimetic chemical sensors using nanoelectronic readout of olfactory receptor proteins", ACS Nano, 5, pp. 5408-5416, 2011.
- [16] T. Wu, Y. Lo, J. Biotechnol, "Synthetic peptide mimicking of binding sites on olfactory receptor protein for use in "electronic nose," 80, pp. 63-73, 2000.
- [17] F. Kremer, A. Schonhals, and W. Luck, "Broadband Dielectric Spectroscopy," Springer-Verlag, 2002.
- [18] S. Dixit, "Film Bulk Acoustic Wave (FBAR) Resonator," International Journal of Scientific and Research Publications, Volume 5, Issue 2, 1 ISSN 2250-3153, February 2015.
- [19] R. Martel, T. Schmidt, H. Shea, T. Hertel, and Ph. Avouris, "Single- and multi-wall carbon nanotube field-effect transistors," Applied Physics Letters. 73 (17): p. 2447, 1998.
- [20] G. Gautschi, "Piezoelectric sensorics," Springer Berlin, Heidelberg, New York. p. 3, 2002.
- [21] C. Wu, "Biomimetic sensors for the senses: towards better understanding of taste and odor sensation," Sensors (Basel), p. E2881, 2017.
- [22] S. Paolini, "Porcine odorant-binding protein: structural stability and ligand affinities measured by fourier-transform infrared spectroscopy and fluorescence spectroscopy," Biochim. Biophys. Acta, 1431, pp. 179-188, 1999.
- [23] M. Rouse, "Electronic nose (e-nose)," March 2016.
- [24] J. Kauer, J. White, "Representation of odor information in the olfactory system: from biology to an artificial nose," Sensors and Sensing in Biology and Engineerin, Berlin, 2002.
- [25] A. Ninfa, D. Ballou, Benore, Marilee, "Fundamental Laboratory Approaches for Biochemistry and Biotechnology," p. 113, 2009.

## “OPeN” - The National Adverse Reactions Database in the Croatian eHealth System

Arian Rajh, Dubravka Sudic, Katarina Gvozdanovic  
 Agency for Medicinal Products and Medical Devices  
 Zagreb, Croatia  
 e-mail: {arajh, dsudic, kgvozdanovic}@halmec.hr

**Abstract**— The Croatian Agency for Medicinal Products and Medical Devices is currently implementing the OPeN project. Once complete, the project will automate the acquisition of pharmacovigilance data from various clinical Information Technology (IT) systems and provide data syndication in the Croatian National Adverse Reactions Database. It will provide a significant contribution to the public health system in Croatia. This paper presents the workings of the OPeN project in the context of the Croatian eHealth system.

**Keywords**— *adverse drug reactions; eHealth system; National Adverse Reactions Database; OPeN; pharmacovigilance.*

### I. INTRODUCTION

The paper “OPeN: Linking the National Adverse Reactions Database with Clinical IT Systems in Croatia,” presented at the Tenth International Conference on eHealth, Telemedicine, and Social Medicine (eTELEMED) in March 2018 in Rome, describes the OPeN system, its mechanisms and expected benefits for the public health system in Croatia [1]. (Figures 2, 3 and 5 in this article were presented for the first time in our eTELEMED conference paper.) “OPeN” is a shortened form of the phrase “online platform for adverse drug reactions (ADRs) electronic reporting” (Online Platforma za elektroničku prijavu Nuspojava, in the Croatian language). The same authors will present an extended version of the subject matter, further addressing implementation of the OPeN project throughout the entire Croatian eHealth system. It is also an update of the work presented at the eTELEMED conference given that OPeN has already been set up on a production environment.

The direct beneficiary of the project is the Croatian Agency for Medicinal Products and Medical Devices (HALMED) [2] and is the national competent authority (NCA) in charge of regulating medicinal products and medical devices in the country. HALMED conducts drug-related pre-approval and post-approval processes; the later comprising pharmacovigilance activities for the detection, analysis, evaluation, interpretation, and deterrence of noxious and unintended drug reactions (i.e., ADRs) [3] [4].

Pharmacovigilance (PhV) is a data-driven discipline where analysis of ADRs relies on multiple data sources such as spontaneous reporting [5], data mining [6] [7], as well as the direct reporting from healthcare professionals (HCPs) working in clinical IT systems. Although spontaneous reporting is a valuable pharmacovigilance source [5], a noticeable problem of underreporting exists [8]. Hence, the European [9]–[11] and global community has standardised

pharmacovigilance practices by issuing general guides [12] and data-related specifications [13] [14], as well as introducing standards for the field [15]–[17]. Therefore, the latter two data-gathering techniques and related data sources are advancements in pharmacovigilance over the last decade. Data mining, as well as direct relevant [18] input from HCPs working in clinical IT systems, have mitigated the issue of underreporting [19]. The contribution by HCPs also increases the data quality because the data is interpreted correctly and communicated by professionals.

This paper systematises and expands the work presented at the eTELEMED conference which described the development of the OPeN system and points out the specific circumstances and its broader ecosystem. OPeN is a system based on the Croatian National Adverse Reactions Database which is maintained by HALMED. Since the interoperability of eHealth components is a significant aspect of “efficiency in the healthcare sector” [20], OPeN aims to achieve integration with the Croatian eHealth environment. The environment, specifically the Croatian Central Health Information System (CEZIH), consists of: the Healthcare Networking Information System (HNIS) operating as an exchange platform, Electronic Healthcare Record (EHR), patient register, register of HCPs, messaging subsystem based on Health Level Seven International (HL7v3 and HL7v2) messages, online patient healthcare website, implemented through the eCitizen website, and specialised services related to e-prescriptions, e-laboratory referrals, e-booking hospital admittance, and numerous other functions [21]. CEZIH was established in 2002 [22]. It started as a primary healthcare IT system, but underwent continual expansion – and in 2010 included the ePrescription service, and later in 2016 incorporated EHR and the patient healthcare website or portal [22]. It operates using other additional client applications for paediatric healthcare, gynaecology, dental healthcare, laboratory diagnostics, pharmacies, hospital and clinical IT systems. The Croatian Health Insurance Fund is responsible for maintaining CEZIH.

In Section II of this article, we will briefly touch upon European projects that have led to the development of the OPeN project and will subsequently describe its goal and main phases. Section III describes the system modules, technical characteristics and mechanisms, and use by internal HALMED users and external HCPs. Further on, Section IV discusses efforts to increase the number and quality of ADRs in Croatia, as well as direct reporting as advancement in Croatian pharmacovigilance, and briefly compares pharmacovigilance systems with direct reporting capabilities.

We will discuss why and how specific pharmacovigilance mechanisms were included in other European systems led by other NCAs and we will compare them to OPeN and efforts taken by HALMED in recent years. Examples from similar European systems were studied as they use direct ADR reporting sourced from clinical systems, which was the primary mechanism for achieving the OPeN project. Finally, in the same section, we discuss the Croatian eHealth environment and the role of OPeN. Section V provides a conclusion, while Section VI outlines future work on the project as well as feasible and desirable advancements in the entire ecosystem.

## II. HALMED'S PARTICIPATION IN IT PROJECTS IN PHARMACOVIGILANCE AND THE LIFECYCLE OF THE OPeN PROJECT

HALMED is responsible for maintaining the national ADR database called VigiBase which is provided by the Uppsala Monitoring Centre (UMC) and the World Health Organization (WHO). To increase capacity in acquiring ADR data from multiple sources, HALMED has participated in two respected and well connected European IT projects in pharmacovigilance– European Commission (EC) Joint Action SCOPE (Strengthening Collaboration for Operating Pharmacovigilance), and Recognising Adverse Drug Reactions (WEB-RADR). SCOPE is a joint action project at the EU level focusing on developing ADR reporting mechanisms [23]. It has produced recommendations for facilitating data collection, data syndication and data disposal to other systems for further processing. WEB-RADR was started in late 2014 and deals with mobile technology, data mining and social media in pharmacovigilance. The project was financed by an initiative that included the 7th Framework Programme means and private contribution, so it represented a private-public partnership between the EU and the European Federation of Pharmaceutical Industries and Associations (EFPIA). Croatian (HALMED), the Dutch MEB (Medicines Evaluation Board), and British MHRA (Medicines and Healthcare Products Regulatory Agency) were NCAs that developed mobile apps for reporting ADRs under WEB-RADR in 2015 and 2016 [24] (see Figure 1). Generally speaking, the projects were well supported by pharmacovigilance practitioners and HCPs in Europe.



Figure 1: HALMED's mobile app QR code for ADR reporting

HALMED has gained experience from these international projects and subsequently initiated a new project called OPeN. [25] OPeN conforms entirely to the SCOPE project recommendation for NCAs who should “integrate suspected ADR reporting into clinical IT systems” [26]. The goal of the OPeN project is to increase both the

number and quality of ADR reports and facilitate communication between HCPs and NCAs through connected clinical IT systems and national ADR databases. The project includes some risks, as all compound projects usually do. Establishing a system as complex as OPeN involves many different institutions and stakeholders (Croatian Ministry of Health, Croatian Health Insurance Fund, Croatian National Institute of Public Health, and IT companies providing solutions and services to the healthcare industry). The most significant risks in this entire process were and still are ensuring necessary funding and providing timely coordination of activities between various stakeholders. The initial plan was to connect OPeN to CEZIH [27] and different hospital IT systems. However, this has not yet been done, with the HALMED staff actively working on it. A possible risk in implementing such integration is the fact that the maintaining of CEZIH is not HALMED's responsibility. Another risk is that there are five clinical hospital centres, three clinical hospitals, five clinics, 20 general hospitals and 24 specialized hospitals in Croatia [28], as well as other participating institutions. Each has various levels of computerisation, and HCPs in these various hospitals use different IT solutions. HALMED has developed the OPeN system to a level where it is now functionally ready; however, other main Croatian stakeholders are required to incorporate the system into the national healthcare ecosystem. The ideal path that should be taken is to enforce providers to incorporate ADR reporting elements into their clinical software products, with various approaches for solving communication issues between systems.

Regarding the project lifecycle, HALMED has finished the first phase of system development, and the project is entering the second phase (see Figure 2). The first phase dealt with facilitating HALMED's internal ADR processing and development of web reporting forms, smart PDF forms and web services to be integrated into the respective clinical IT systems. The result of the first phase is a functional web-based ADR reporting form and completed OPeN ingest functionality. The OPeN system interface is user-friendly to simplify data entry and decrease the time required for data entry. During ADR reporting, an individual HCP selects field values from various lists of medicinal products, institutions, units, and measurements. Users can also choose from one of the existing templates for new reports. Although the web-based application OPeN is fully functional and it can be used for data transmission, HALMED is aiming to sign the protocol with the Croatian National Institute of Public Health. This protocol is essential for data exchange between the institute and HALMED and the future use of OPeN in the entire Croatian eHealth ecosystem. This is the goal of the second phase. The OPeN system will be fully operational nationally only after strengthening such cooperation. This procedure turned out to be a complicated legal and administrative matter in Croatia, but the institute has received permission from the Croatian Personal Data Protection Agency to share the data, acting as the national data-protection authority. Moreover,

the Croatian Ministry of Health has adopted certain activities for OPeN as one of their strategic goals for 2019. HALMED has also declared OPeN as one of its general goals in its official 2019-2021 Strategic Plan. In parallel with the signing of the data protocol and preparation of the second phase, HALMED has begun planning the third phase (see Figure 2), i.e., upgrading the system with an additional module that informs HCPs and facilitates their ongoing training in the form of online courses.

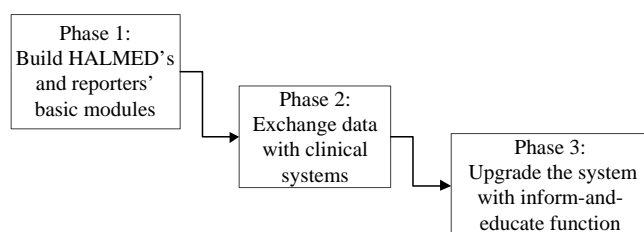

Figure 2. Development phases for the OPeN system.

### III. OPEN – DEVELOPMENT, MECHANISMS AND RESULTS

HALMED's goal in this project is to automate direct reporting of adverse drug reactions by HCPs, using existing workplace IT systems.

OPeN has been developed as a web-based application that consists of a database, a web interface, and web services for integration with other IT systems (external clinical IT systems and other IT systems at HALMED). OPeN is based on Windows technology and developed using the .NET Framework, whereas the data is stored in the as Microsoft's Structured Query Language on a server database (MS SQL). The database is organized in multiple schemes and contains data and procedures for system operation, such as configuration data, user data, data on healthcare facilities, and all data on adverse drug reactions including their logging and processing. Wherever possible, the data is structured into more than 40 data lists, a part of which is accessible to users via a web service.

A firewall and the Secure Sockets Layer (SSL) protocol protects the entire system. Access and data protection are established through domain admin policies for internal users (Windows Active Directory) and for external users. Backup procedures are performed regularly.

The scenario is as follows: an individual HCP submits a report and transfer it to HALMED, where assigned staff processes the report (see Figure 3).

There are three possible ways of sending data on side effects to OPeN; via the Internet and web application, sending the prefilled smart PDF document via e-mail or directly via the IT systems HCPs use at their workplace (if the system is connected to OPeN, as predicted by the phase 2 result).

The web layer of OPeN consists of two modules: a module for HALMED employees and a module for external

users (HCPs). HALMED employees use the system to register and validate received reports, detect duplicates, assign them to assessors, and track further processing and steps, such as forwarding them to the EudraVigilance system [29], as well as other tasks. The module for HALMED employees is also connected to the HALMED Enterprise Content Management System (ECMS) via web services, where all the digital records are stored. These digital records are available for reading and editing in the OPeN system throughout the entire process.

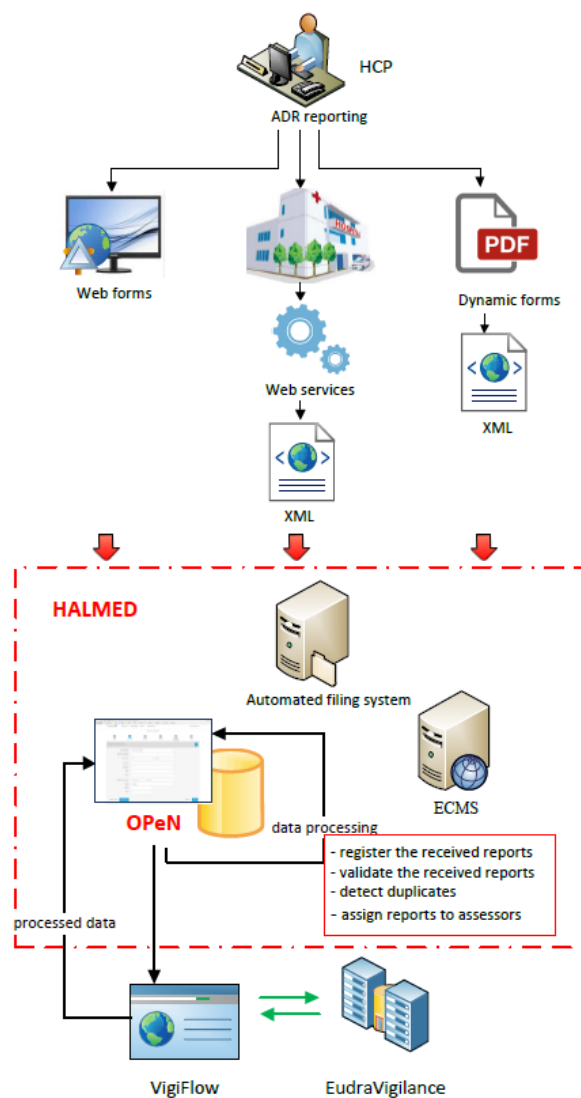

Figure 3. The OPeN workflow

Registered HCPs use the module assigned for external users to report adverse drug reactions. In the form for entering the drug or vaccine data, users enter one or more drugs (one or more vaccines which are suspected) or concomitant substances (see Figure 4). The fields in Figure 4 are as follows: Drug (medicinal product), Active

Ingredient, Marketing Authorisation Holder (MAH), Dosage, the checkbox for Vaccines, the checkbox for Suspected drug, Drug Consumption Start Date, Drug Consumption End Date, its Duration, Batch Number for the drug, and Single Dosage. The drugs are selected from the list and then other drug data, such as the active substance, dosage and MAH, are completed automatically. The user can also specify the name of the drug.

Figure 4. Form for entering one or more suspected drugs

OPeN users can enter optional information for any drug such as start date of drug consumption, end date of drug consumption, duration of treatment, dose interval, amount of administered doses in a selected interval, single dosage, batch number, indication, and administration route. Also, users can enter information about whether adverse reactions ceased after completing therapy or whether adverse reactions reappeared upon re-administering the drug. In the application dashboard, the reporter can view all entered adverse drug reactions and a status report. Views include an overview of unrecorded side effects, received side effects, side effects awaiting acceptance, side effects assigned to somebody, side effects approaching the processing deadline, side effects awaiting a severity rating, side effects assigned

to the current user, side effects awaiting entry, as well as side effects assigned to the current user and awaiting a severity rating. The system alerts the user if data concerning an applicant or patient is missing, or if an error has occurred such as an upload error or check-in error, and it shows the status of the application. Figure 5 shows the OPeN interface; with the example indicating creation dates and statuses “Received in OPeN” and “Task accepted” in the last row.

Kreirano	Status
19.7.2017.	Zaprimljeno u OPeN
19.7.2017.	Zaprimljeno u OPeN
19.7.2017.	Zaprimljeno u OPeN
19.7.2017.	Prihvaćeno zaduženje
20.7.2017.	Čeka prihvrat zaduženj
19.7.2017.	Završeno
19.7.2017.	Poslan XML
19.7.2017.	Završeno

Figure 5. The OPeN interface for data entry

All institutions that participate in data exchange use the same list of HCP authentication data. This facilitates exchanging data without additional authentication when sending the data to HALMED. A common list provides data traceability. Data exchanged between internal and external systems is in XML data format, and XML structures adhere to E2B-R2 and E2B-R3 formats [13] [14]. ADR reporting is carried out via an HTTP POST request to the endpoint: <http://open.halmed.hr/client/#/login>. All required lists can be downloaded via the web service available on the following website:

<http://open.halmed.hr/CodeBookService/CodeBookService.svc>. The site provides the following lists: Doubt, Consequence, Age Unit, Gender, Medication, Outcome, Duration Unit, Time from Consumption to Reaction Unit, Side Effect Medicine Correlation, Measurement Unit, Dosing Interval Unit, Application Type, Drug Consumption Change, Drug Reapplication Status, Drug Discontinuation, Application Location, Profession, Vocation, County, and Country.

In the first phase of the project, HALMED also developed a smart PDF form containing embedded lists. The form is available on the HALMED and OPeN websites



[25]. Anyone can access the form, complete it and send it via e-mail. OPeN automatically loads data from the form into the OPeN database, eliminating the need to enter data manually. HALMED has provided instructions on various reporting tasks for the general public, patients and HCPs on the PhV section of its website (<http://www.halmed.hr/en/Farmakovigilancija/Kako-prijaviti-nuspojavu/> for English page).

#### IV. DISCUSSION ON THE OPeN AND EHEALTH SYSTEMS IN CROATIA

Due to their significant contribution to an efficient eHealth ecosystem, we will highlight some of the OPeN possibilities, such as integration and communication with other systems, as well as current coding and data mapping abilities. To grasp the importance of direct reporting and main points of the OPeN system, we will provide a historical development of reporting in Croatia, benefits of the reporting function, direct reporting trends in other countries, and the national eHealth system as a broader field in the direct reporting.

##### A. Efforts to increase the number and quality of ADRs in Croatia over the last decade

Spontaneous ADR reporting is the keystone of pharmacovigilance. A sufficient number of high-quality ADR reports are directly correlated to the effectiveness of ADR system capacity in detecting drug safety issues. ADR systems rely on the goodwill of HCPs and patients, not only on identifying suspected ADR reports but also reporting them. ADR reporting schemes are recognised as being underreported [8] [30] [31]. Directive 2010/84/EU, which came into force in 2013, identified this issue and stated that NCAs need to encourage and improve reporting of ADRs. According to Article 102 of the Directive, NCAs shall “take all appropriate measures to encourage patients, doctors, pharmacists and other healthcare professionals to report suspected adverse reactions to the national competent authority” [32]. Heads of medicines agencies (HMA) incorporated the aim of the Directive into their 2011-2015 Strategy [33]. HMA aims to support the strengthening of spontaneous ADR reporting systems, indicating four main complementary approaches as a means of improving ADR reporting and achieving a more robust national pharmacovigilance system: (1) education, (2) motivation, (3) promotion, and (4) facilitation of ADR reporting, all of which are mainly directed to HCPs and patients.

Throughout the last decade, HALMED has joined in numerous activities to increase the number and quality of reported ADRs in Croatia. The number of spontaneous ADR reports increased from 856 in 2007 to 3486 in 2016, ranking Croatia in the top ten countries in the world for a number of ADRs per million inhabitants [34]. Education, motivation, and promotion have been extensively used and combined with different ways of making reporting easier. This was done by introducing novel methods for capturing

ADRs: an online reporting form for patients to complete as well as a mobile app for patients and HCPs. The online reporting form was launched in 2012, and by 2016 a total of 20% of all ADRs were received through this channel. Although HALMED intended the online reporting form to be for patients, it was also widely used by HCPs. The PhV mobile app was introduced in 2016 (through the project WEB-RADR) and accounted for the 2% of ADR received in 2016. The focus was on activities aimed at making reporting easier. HALMED started introducing electronic reporting which encouraged rationalisation of internal ADR processing. The main reasoning behind this was to decrease manual entries into the national ADR database. This issue has gained in importance as an increasing number of received ADRs begins to have a real impact on resources available to other pharmacovigilance processes at HALMED (e.g., assessments of risk management plans, periodic update of safety reports).

##### B. Direct reporting from clinical systems - an advancement in pharmacovigilance

Although the regulatory workload at HALMED has increased substantially since 2013, there remains an active commitment to improving the national PhV system, as well as opening up possibilities for detecting signals and safety issues. This was the reason for planning and starting the OPeN project. OPeN aims to automate the internal handling of reported ADRs and to further increase both the number and quality of ADR reports transmitted to HALMED. Capturing ADR reports from online reporting forms and clinical systems should ensure this. The idea behind OPeN is to build a system that will allow communication between clinical IT systems and the national ADR database. HALMED considers the capturing of ADR reports from clinical systems in electronic form to be the most challenging part of the project. Direct reporting from clinical systems, however, has many advantages. It improves the efficacy of reporting of HCPs by making the completion of forms easier as it uses data from patient records and automates data entry methods. HALMED considers it to be a way of promoting ADR reporting in general. Based on a systematic review and meta-analysis published by I. Ribeiro-Vaz et al. [35], projects that aim to promote ADR reporting by harnessing IT solutions are an increasing trend. According to their aggregate analysis, these solutions have doubled the number of captured ADR reports.

Reporting from the clinical system helps in acquiring comprehensive information on ADRs. It facilitates case assessment by providing the surrounding circumstances for ADRs. An added value is the ability to prompt reporters to complete a report in the system once specific tasks are completed, e.g., withdrawing a drug from administered therapy. It can also prompt a reporter to enter more specific report data (e.g., the batch number if ADR comes from vaccines and biologicals). This ADR information is rarely



captured in paper form; however, it can be crucial in understanding ADR causes.

An additional benefit of an automatic data entry method in direct ADR reporting from a clinical system is the use of controlled data entries. Where applicable, ADR reporters may use data registries (e.g., medicinal product registry) to facilitate the data entry method. Another benefit of using IT solutions is using data validation rules and making it easier to receive accurate and valid reports. Consequently, national ADR databases are becoming more accurate. It reduces the need to contact a reporter in case of non-valid ADRs. Rules of reporting should meet the applicable ICH E2B standards [13] [14], and minimum required data. Additional validation rules should also be incorporated to meet business or regulatory requirements. Also, the use of dictionaries, including the mapping of dictionaries, helps establish standardised terminology and coding terms for assessors. The use of dictionaries represents a significant benefit for any pharmacovigilance system. The second phase of OPeN addresses these very issues.

### C. A brief comparison of pharmacovigilance systems with mechanisms for capturing ADRs from clinical systems

According to the SCOPE results, there are only 3 NCAs or regulatory agencies that utilize the possibility of capturing ADRs from clinical systems: the Spanish AEMPS (Agencia Española de Medicamentos y Productos Sanitarios), the British MHRA (Medicines and Healthcare products Regulatory Agency) and the Netherlands Pharmacovigilance Centre Lareb [36] - [38]. Their systems mainly aim to retrieve ADRs from general practitioners (GPs). This is a logical decision given that GPs have access to most of a patient's health information.

Although systems differ, their experiences indicate that the integration of ADR reporting into electronic health records, primary healthcare, and e-prescription systems correlates positively with an increased number of received ADR reports and quality of received information. Spain integrated its ADR reporting system with HER, the primary healthcare and e-prescription solution back in 2010. The Spanish use a 'Nomenclator' dictionary maintained by AEMPS. The use of the International Classification of Diseases (ICD) is also recommended.

In the UK, for example, during the pilot phase of the system in 2011, automatic ADR reporting feature was added to a primary care system (SystemOne) for GPs. Analysis of received Yellow Cards showed an increase for GP ADR reports of almost 50% compared to 2010. Specific information, the standard for electronic Yellow Card reporting, was developed for the English National Health Service (NHS) in 2012 [39]. It was based on the ICH E2B(R2) standard [13] and prescribed use of the electronic Yellow Card message.

In the Netherlands, professional bodies and GPs have implemented an electronic reporting module linked to the GPs medical records. The Netherlands PhV Centre Lareb

integrated the reporting of suspected ADRs in healthcare systems using a specific method. Once a physician enters an ADR in patient records, an alert pops up to prompt reporting of ADRs. It opens a partly completed reporting form on the GP's computer screen for further completion. The second method is to send reported ADRs which are recorded in registries automatically to Lareb. The initiative commenced in 2014, and the first reports from the registry began arriving in December 2015. Both initiatives were in the pilot phase during the SCOPE report, with a few sites sending the reports. From mid-March 2016, plans focused on developing reporting forms for the GP information system. With regards to education, there has been no special education for reporting ADRs using these two new methods. The UK and Spanish systems follow a similar concept. There are some differences between the systems. ADRs received from clinical systems in Spain are not automatically uploaded into the national database at Farmacovigilancia Española, Datos de Reacciones Adversas (FEDRA), but pass through regional PhV centers. Also, the ADR description is authored by the HCP, while the UK system codes the ADRs in compliance with the dictionary called the *Systematized Nomenclature of Medicine* (SNOMED) [40]. The MHRA has implemented a mapping between the SNOMED terms and the *Medical Dictionary for Regulatory Activities* (MedDRA) [41] which is standard terminology used for coding ADRs worldwide. It enables ADR reports to be automatically loaded into the PhV database at MHRA without coding ADRs.

In comparison, OPeN allows direct upload of ADR reports to the national database. However, coding of ADRs by the reporter will not be possible. Also, the Croatian eHealth system does not use SNOMED, but coding lists are agreed upon at a national level to ensure interoperability [20]. HCPs in Croatia use the International Statistical Classification of Diseases and Related Health Problems 10 (ICD 10) terminology for coding medical terms [42], and there is no mapping to MedDRA.

Also, OPeN provides two-way communication with reporters, mainly for retrieving follow-up information. We believe this is the benefit our system offers, although details on the communication possibilities within the UK or Spanish systems are not widely available. There is limited published information on particular data elements of both systems. We were able to compare our systems solely by actively participating in the SCOPE project. However, information on the systems may be outdated, given that SCOPE includes data only before 2013. Moreover, it is a challenge in finding information about publication activities from other countries when implementing ADR reporting from clinical systems. Previous research of the systems outlined above has enabled the HALMED team to avoid some problems in developing, implementing, and fine-tuning of the OPeN system. The primary challenge in this type of projects in other countries was the integration of the reporting form into the particular system logically and

without seeking too much or too little additional information. Ensuring patient privacy was also important. HALMED's team members have used these valuable lessons during the development of the OPeN system.

#### D. OPeN - vital to the Croatian eHealth ecosystem

In general, eHealth systems consist of electronic medical records (EMR) produced by particular HCPs, EHR (generated by all HCPs), as well as personal healthcare records (PHR) verified by patients [20].

The eHealth system in Croatia provides two functions: an integration platform for local information systems used in GP practices, pharmacies, laboratories, hospitals, and a centralised national application accessible via a web interface. Generally, the business process runs in the following manner: nurses and GPs use client applications for processing patient information. Client applications utilize captured information, transforming it into patient summaries, prescriptions, referrals for hospitalization or specialist reports, referrals to laboratory analyses, and the like. These messages are sent to the central core of CEZIH which is available to other healthcare participants. For example, a pharmacist retrieves a prescription from his client-side application, dispenses the particular medication and sends the relevant information back to the CEZIH centre, which is also accessible to the prescriber. An Analogous process exists with referrals and which are retrieved by hospital or laboratory personnel, after which the discharge letters and laboratory results are sent back to CEZIH, and subsequently to the referring party [22]. Additional available services are infectious disease reporting, malignant disease reporting, sick leave reports, adverse effects during immunization, retrieval of administrative information from insurance perspectives and other types of reports. Authentication is supported with smart cards for HCPs, and information security is supported with CEZIH and client applications such as VPN, firewall, SSL/TLS and encryption. [22]. Messages are stored by the system and have a non-repudiation quality [22]. Some of the most relevant information that originates from mechanisms such as patient visit summaries, ePrescription and eReferral are transformed and provided to healthcare professionals via the EHR application after establishing appropriate authorization and in line with patient consent. The limited scope of medical information is also available for review via dedicated patient websites where consent for accessing EHR can also be given and revoked, and information on access to a patient's EHR can be reviewed.

The design enables OPeN to anticipate connections between the actual system and the Croatian eHealth environment (CEZIH) as well as related physician, pharmacy and hospital IT systems. Most of the data required for reporting ADRs is already contained in the IT systems of HCPs, hence filling out the forms takes less time, and it also simplifies the process of sending data to HALMED. The outcome is an increase in the quality of transmitted data,

less chance of errors during data entry and preventing the submission of incorrect or incomplete forms.

#### V. CONCLUSIONS AND EXPECTED BENEFITS

Submissions of timely and properly completed ADR reports increases the data available to NCAs and their capacity to raise public health. It improves the ability NCAs to detect, identify, investigate and act on potential drug safety issues.

Pharmacovigilance professionals consider the integration of clinical IT systems and ADR databases as a bleeding edge tool for increasing both the number and quality of captured ADRs. HALMED has established OPeN for this very reason. As the Croatian NCA for drugs, HALMED has started an initiative that has aimed to integrate the national ADR database, CEZIH, and various hospitals IT systems. The expected benefits include:

- Facilitation and promotion of ADR reporting,
- A higher number and better quality of reports,
- Less manual data entry and data processing time per the report,
- Standardisation, clarification of professional terms, dictionaries,
- The introduction of analytics, advancement in tracking key performance indicators (KPI) and signals, planning for BI features,
- Improving guidance on drug prescriptions,
- Sophisticated and proactive protection of public healthcare based on interpretation of complex drug reaction reports provided by modern IT solutions.

The last benefit stems from the result of integrating OPeN and CEZIH, and this will be possible once data between the Croatian Health Insurance Fund and HALMED, or their CEZIH and OPeN systems is exchanged.

#### VI. FURTHER WORK

An efficient and connected healthcare system facilitates the protection of patients, efforts by HCPs and has benefits for all other stakeholders in the national healthcare industry. The OPeN system is an excellent example of utilizing important pharmacovigilance mechanisms and convenient technological elements in the national health system. HALMED will upgrade it with additional functions in the future, and we firmly believe that the sustainability of the project is ensured.

#### REFERENCES

- [1] A. Rajh, D. Sudic, and K. Gvozdanovic, "OPeN: Linking the National Adverse Reactions Database with Clinical IT Systems in Croatia." *The Tenth International Conference on eHealth, Telemedicine, and Social Medicine (eTELEMED) IARIA*, March 2018, pp. 54-59.
- [2] Agency for Medicinal Products and Medical Devices of Croatia. *About HALMED*. [Online], Available from: <http://www.halmed.hr/en/O-HALMED-u/> [last access: 11/08/2018]
- [3] European Medicines Agency. *Pharmacovigilance*. [Online], Available from:

- [http://www.ema.europa.eu/ema/index.jsp?curl=pages/regulation/general/general\\_content\\_000258.jsp](http://www.ema.europa.eu/ema/index.jsp?curl=pages/regulation/general/general_content_000258.jsp) [last access: 11/08/2018]
- [4] I. R. Edwards and J. K. Aronson, "Adverse drug reactions: definitions, diagnosis, and management," *The Lancet*, vol. 356, issue 9237, pp. 1255 – 1259, Oct. 2000.
  - [5] N. Mirosevic Skvrce et al., "Adverse drug reactions caused by drug-drug interactions reported to Croatian Agency for Medicinal Products and Medical Devices: a retrospective observational study," *Clinical Sciences*, vol. 52, issue. 5, pp. 604-614, Oct. 2011, doi: 10.3325/cmj.2011.52.604
  - [6] M. Liu, M.E. Matheny, Y. Hu, and H. Xu, "Data Mining Methodologies for Pharmacovigilance," *ACM SIGKDD Explorations Newsletter*, vol. 14, issue 1, pp. 35-42, June 2012, doi: 10.1145/2408736.2408742
  - [7] A. M. Wilson, L. Thabane, and A. Holbrook, "Application of data mining techniques in pharmacovigilance," *British Journal of Clinical Pharmacology*, vol. 57, issue 2, pp. 127–134, Feb. 2004, doi:10.1046/j.1365-2125.2003.01968.x
  - [8] L. Hazell and S.A. Shakir, "Under-reporting of adverse drug reactions: a systematic review," *Drug Saf.* 2006; vol. 29, issue. 5, pp. 385-396, May 2006, doi:10.2165/00002018-200629050-00003
  - [9] European Medicines Agency. Information Management Division. *Master Data Management Roadmap: Substance, Product, Organisation and Referential data*, 23 April 2015. [Online]. Available from: [http://www.ema.europa.eu/ema/pages/includes/document/open\\_document.jsp?webContentId=WC500186290](http://www.ema.europa.eu/ema/pages/includes/document/open_document.jsp?webContentId=WC500186290) [last access: 11/08/2018]
  - [10] European Medicines Agency. *Monitoring of medical literature and entry of adverse reaction reports into EudraVigilance*. [Online]. Available from: [http://www.ema.europa.eu/ema/index.jsp?curl=pages/regulation/general/general\\_content\\_000633.jsp&mid=WC0b01ac05808ce84c](http://www.ema.europa.eu/ema/index.jsp?curl=pages/regulation/general/general_content_000633.jsp&mid=WC0b01ac05808ce84c) [last access: 11/08/2018]
  - [11] European Medicines Agency. *Reporting requirements for marketing-authorisation holder*. [Online]. Available from: [http://www.ema.europa.eu/ema/index.jsp?curl=pages/regulation/general/general\\_content\\_000594.jsp&](http://www.ema.europa.eu/ema/index.jsp?curl=pages/regulation/general/general_content_000594.jsp&) [last access: 11/08/2018]
  - [12] ICH, FDA, Center for Drug Evaluation and Research (CDER), Center for Biologics Evaluation and Research (CBER). *Guidance for Industry - E2B(R3) Electronic Transmission of Individual Case Safety Reports (ICSRs) Implementation Guide – Data Elements and Message Specification*, February 2014.
  - [13] ICH E2B(R2). *Individual Case Safety Report (ICSR) Specification and Related Files*. [Online]. Available from: <http://www.ich.org/products/electronic-standards.html> [last access: 08/08/2018]
  - [14] ICH E2B(R3). *Individual Case Safety Report (ICSR) Specification and Related Files*. Available from: <http://www.ich.org/products/electronic-standards.html> [last access: 08/08/2018]
  - [15] European Medicines Agency. *Substance, Product, Organisation and Referential (SPOR) master data*. [Online]. Available from: [http://www.ema.europa.eu/ema/index.jsp?curl=pages/regulation/general/general\\_content\\_000645.jsp&mid=WC0b01ac058078fbe2](http://www.ema.europa.eu/ema/index.jsp?curl=pages/regulation/general/general_content_000645.jsp&mid=WC0b01ac058078fbe2) [last access: 11/08/2018]
  - [16] ISO/HL7 27953-1: 2011 Health informatics – Individual Case Safety Reports (ICSRs) in pharmacovigilance – Part 1: The framework for adverse event reporting
  - [17] ISO/HL7 27953-2: 2011 Health informatics – Individual Case Safety Reports (ICSRs) in pharmacovigilance – Part 2: Human pharmaceutical reporting requirements for ICSR
  - [18] T. Saracevic, "Relevance: A Review of and a Framework for Thinking on the Notion in Information Science," *Journal of American Society for Information Science*, vol.26, issue 6, pp. 321-343, Nov. 1975, doi: 10.1002/asi.4630260604
  - [19] J. Almenoff et al., "Perspectives on the Use of Data Mining in Pharmacovigilance," *Drug-Safety* vol 28 (11), pp. 981-1007, 2005, doi:10.2165/00002018-200528110-00002
  - [20] D. Gvozdanovic et al. (2015), "Interoperability Within E-Health Arena." In *Proceedings of the Fourth International Conference on Telecommunications and Remote Sensing* (Vol. 1, ICTRS, pp. 81-86). Bulgaria: SCITEPRESS. doi:10.5220/0005889800810086
  - [21] 2016 Annual Report Ericsson Nikola Tesla Group General Report. (2016). Retrieved from [https://www.ericsson.hr/documents/20181/21890/ar2016\\_en\\_general.pdf/495d6bff-e782-4878-ba8a-6cfc9603f082](https://www.ericsson.hr/documents/20181/21890/ar2016_en_general.pdf/495d6bff-e782-4878-ba8a-6cfc9603f082) August, 2018.
  - [22] Ministry of Health of the Republic of Croatia. (2013, November 26). Centralni zdravstveni informacijski sustav Republike Hrvatske (CEZIH) - Koncept sustava (2/15517-FCPBA 101 24/8 Uhr Rev B). Retrieved August, 2018, from [http://www.cezih.hr/pzz/dokumentacija/01\\_00\\_CEZIH\\_koncept\\_sustava.pdf](http://www.cezih.hr/pzz/dokumentacija/01_00_CEZIH_koncept_sustava.pdf)
  - [23] SCOPE Work Package 4 ADR Collection, *IT Systems for ADR Reporting: Best Practice Guide* [Online], Available from: [http://www.scopejointaction.eu/\\_assets/files/WP4-IT-Systems-for-ADR-Reporting-BPG.pdf](http://www.scopejointaction.eu/_assets/files/WP4-IT-Systems-for-ADR-Reporting-BPG.pdf) [last access: 11/08/2018]
  - [24] IMI. *WEB-RADR: Recognising Adverse Drug Reactions*. [Online]. Available from: <https://web-radr.eu/> [last access: 11/08/2018]
  - [25] HALMED. *Open (v.0.2.66.0)* [Online], Available from: <https://open.halmed.hr/client/#/login> [last access: 08/28/2018]
  - [26] SCOPE Work Package 4 ADR Collection, *Increasing Awareness of National Adverse Drug Reaction Reporting Systems: Best Practice Guide*. [Online], Available from: [http://www.scopejointaction.eu/\\_assets/files/WP4.3-Survey-Report-layout-draft-4-final.pdf](http://www.scopejointaction.eu/_assets/files/WP4.3-Survey-Report-layout-draft-4-final.pdf) [last access: 11/08/2018]
  - [27] Central Health Information System of the Republic of Croatia (CEZIH). [Online], Available from: <http://www.cezih.hr/> [last access: 11/08/2018]
  - [28] Ministry of Health of the Republic of Croatia. Zdravstvene ustanove u Republici Hrvatskoj. Retrieved August 9, 2018, from <https://zdravlje.gov.hr/arhiva-80/ministarstvo-zdravlja/zdravstvene-ustanove-u-republici-hrvatskoj/656>
  - [29] European Medicines Agency. *EudraVigilance*. [Online]. Available from: [http://www.ema.europa.eu/ema/index.jsp?curl=pages/regulation/general/general\\_content\\_000679.jsp&mid=WC0b01ac05800250b5](http://www.ema.europa.eu/ema/index.jsp?curl=pages/regulation/general/general_content_000679.jsp&mid=WC0b01ac05800250b5) [last access: 11/08/2018]
  - [30] Y. Moride, F. Haramburu, A. A. Requejo, and B. Begaud. (1997) "Under-reporting of adverse drug reactions in general practice." *British Journal of Clinical Pharmacology*, vol. 43, issue 2, pp. 177-181, Feb. 1997, doi: 10.1046/j.1365-2125.1997.05417.x
  - [31] R. M. Martin, K. V. Kapoor, L. V. Wilton, and R. D. Mann, "Underreporting of suspected adverse drug reactions to newly marketed ("black triangle") drugs in general practice: an observational study." *BMJ*, vol. 317, issue 7151, pp. 119-120, July 1998. [Online]. Available from: <http://www.bmj.com/content/317/7151/119> [last access: 11/08/2018]
  - [32] Official Journal of the European Union. *Directive 2010/84/EU of the European Parliament and of the Council* [Online], Available from: [https://ec.europa.eu/health/sites/health/files/files/eudrallex/vol-1/dir\\_2010\\_84/dir\\_2010\\_84\\_en.pdf](https://ec.europa.eu/health/sites/health/files/files/eudrallex/vol-1/dir_2010_84/dir_2010_84_en.pdf) [last access: 11/08/2018]

- [33] Heads of Medicines Agencies. *A Strategy for the Heads of Medicines Agencies, 2011-15*. [Online]. Available from: [http://www.hma.eu/fileadmin/dateien/HMA\\_joint/02-HMA\\_Strategy\\_Annual\\_Reports/02-HMA\\_Strategy\\_Paper/2010\\_12\\_HMA\\_StrategyPaperII.pdf](http://www.hma.eu/fileadmin/dateien/HMA_joint/02-HMA_Strategy_Annual_Reports/02-HMA_Strategy_Paper/2010_12_HMA_StrategyPaperII.pdf) [last access: 11/08/2018]
- [34] HALMED. *Adverse Drug Reaction Report for 2016* [Online]. Available from: [http://www.halmed.hr/fdsak3jnFsk1Kfa/ostale\\_stranice/Izvjesce-o-nuspojavnima-za-2016.pdf](http://www.halmed.hr/fdsak3jnFsk1Kfa/ostale_stranice/Izvjesce-o-nuspojavnima-za-2016.pdf) [last access: 11/08/2018]
- [35] I. Ribeiro-Vaz, A. M. Silva, C. Costa Santos, and R. Cruz-Correia, "How to promote adverse drug reaction reports using information systems – a systematic review and meta-analysis." *BMC Medical Informatics and Decision Making*, vol. 16, issue 27, Mar 2016, doi:10.1186/s12911-016-0265-8 [Online]. Available from: <https://www.ncbi.nlm.nih.gov/pmc/articles/PMC4772685/#> [last access: 11/08/2018]
- [36] Agencia Española de Medicamentos y Productos Sanitarios (AEMPS). *Portada La AEMPS*. [Online]. Available from: <https://www.aemps.gob.es/laAEMPS/portada/home.htm> [last access: 11/08/2018]
- [37] Medicines and Healthcare products Regulatory Agency (MHRA). *About us*. [Online]. Available from: <https://www.gov.uk/government/organisations/medicines-and-healthcare-products-regulatory-agency/about> [last access: 11/08/2018]
- [38] Netherlands Pharmacovigilance Centre Lareb. Available from: <https://www.lareb.nl/en/> [last access: 28/08/2018]
- [39] ISB 1582 Electronic Yellow Card Reporting' standard. Available from: <http://www.isb.nhs.uk/documents/isb-1582> [last access: 28/08/2018]
- [40] SNOMED International. *SNOMED CT*. [Online]. Available from: <https://www.snomed.org/snomed-ct> [last access: 11/08/2018]
- [41] MedDRA MSSO. *MedDRA. Medical Dictionary for Regulatory Activities*. [Online]. Available from: <https://www.meddra.org/> [last access: 11/08/2018]
- [42] eHDSI MVC. *WHO ICD-10 The International Statistical Classification of Diseases and Related Health Problems 10th Revision*. [Online]. Available from: <https://ec.europa.eu/cefdigital/wiki/display/EHSEMANTIC/WHO+ICD-10+The+International+Statistical+Classification+of+Diseases+and+Related+Health+Problems+10th+Revision> [last access: 11/08/2018]

## Evaluating an Evidence-Based mHealth Application, MS Assistant, for Individuals Aging with Multiple Sclerosis

Ljilja Ruzic, Harshal P. Mahajan, and Jon A. Sanford

The Center for Assistive Technology and Environmental Access (CATEA)  
Georgia Institute of Technology  
Atlanta, GA, USA

e-mail: [ljilja@gatech.edu](mailto:ljilja@gatech.edu), [harshal.mahajan@design.gatech.edu](mailto:harshal.mahajan@design.gatech.edu), [jon.sanford@design.gatech.edu](mailto:jon.sanford@design.gatech.edu)

**Abstract**—A majority of individuals diagnosed with MS experience major decline in their abilities due to the progression of MS, five years post-diagnosis and after age 40. Following this period, they need to learn how to cope with the functional limitations and disabilities caused by the condition and how to age with MS due to an early onset of age-related problems. In addition to the signs of early aging caused by MS symptoms and consequent impairments, these individuals experience increased disability due to the physical effects of aging and comorbidities. As a result, they have to manage the effects of the condition on their lives every day. Self-management can help mitigate the symptoms associated with MS. mHealth applications offer potential holistic support for self-management of the condition as they represent more robust technologies that have potential to include all the interventions proven to be useful to manage multiple health problems. This research paper describes the evaluation of the mHealth app, MS Assistant, an evidence-based app that provides the daily support and self-management of the condition to individuals aging with MS, which was developed based on the Universal Design Mobile Interface Guidelines, UDMIG v.2.1. mHealth application was evaluated by the expert reviewers. Moreover, the paper presents an app refinement based on the suggestions of the experts who tested the effectiveness of the app and its design features and provided possible recommendations for its redesign.

**Keywords**- aging; mHealth; multiple sclerosis; universal design.

### I. INTRODUCTION

This research paper details the evaluation of the mobile health (mHealth) application for individuals aging with Multiple Sclerosis (MS) by the expert reviewers. The study tested the effectiveness of the mobile app and its design features and resulted in the recommendations for the user interface redesign [1].

MS is a complex inflammatory disorder of the Central Nervous System (CNS) [2]. This chronic and progressive disease is affecting around 400,000 individuals in the US and 2.5 million people worldwide, with approximately 10,000 newly diagnosed cases of MS annually [2]. MS is characterized by a large number and variety of symptoms [3]. Cognitive changes and mobility limitations (e.g., spasticity, weakness in one or more limbs, gait difficulties) are the most significant ones related to disability [3].

A majority of individuals diagnosed with MS experience significant declines in their abilities due to the progression of MS after five years post-diagnosis and especially after age 40 [4]. Following this period, they need to learn how to cope with the functional limitations and disabilities caused by the condition and how to age with MS due to an early onset of age-related problems [4][5]. In addition to the signs of early aging caused by MS symptoms and consequent impairments, these individuals experience increased disability due to the physical effects of aging and comorbidities [6][7].

As a result, these individuals have to manage the effects of the condition on their lives every day [3]. More specifically, they need a continuous disease, symptom, and medication management, coupled with education and effective strategies for addressing the exacerbations (i.e., a worsening of old symptoms or an onset of new symptoms for at least 24 hours, also called a relapse) [8]. They need to understand their condition to take charge of managing MS and related impairments [8].

Self-management can help mitigate the symptoms associated with MS [8]-[12]. To support self-management, access to pertinent information, resources, and education about the nature of MS, the treatment, and methods for improving quality of living (QOL) delivered in an appropriate way could considerably improve lives of individuals with MS [13]. Additionally, research studies [14]-[16] suggested that self-management interventions using telehealth (i.e., remote-patient monitoring) have a potential for overcoming access barriers in MS. Social support is another way of enhancing the QOL in people with MS. Moreover, the World Health Organization (WHO) [13] and the Consortium of Multiple Sclerosis Centres [17] advise that individuals with MS take control of decisions affecting their wellness and life and self-manage their condition as often as possible. As a result, there is a great need for efficient tools to support the health and wellness self-management of daily activities for individuals with MS.

mHealth apps offer potential holistic support for self-management of the condition as they represent more robust technologies that have the potential to include all the interventions proven to be useful to manage multiple health problems [18]. These health and wellness self-monitoring applications offer a range of tools to assist with health and wellness daily organization, communication with healthcare providers, and education [18].

This research paper details the evaluation of the mHealth app, MS Assistant, an evidence-based app that provides daily support and self-management of the condition to individuals aging with MS. mHealth application was evaluated by the expert reviewers, who provided recommendations for app redesign. Moreover, a summary of an app refinement based on the suggestions of the expert reviewers is presented here.

The paper is organized into six sections. Section I provided a background. Section II reviews the related work about technological support for people with MS and other chronic conditions that share similar symptoms with MS. Section III describes the initial design of MS Assistant. Section IV summarizes the evaluation of the effectiveness of the design features and the app through an expert review. Section V presents the refinement of MS Assistant based on the recommendations of the experts. Section VI provides a conclusion and proposes future work.

## II. RELATED WORK

The majority of individuals with MS use modern communication technology regularly (i.e., personal computer, internet, email, mobile phone) [19]-[21]. They have high levels of acceptance for using electronic communication methods for exchanging information with health care providers. Ninety-six percent of them possessed mobile phones, and older participants used it less frequently. However, there is a lack of relevant previous research on the needs and concerns of individuals aging with MS [6] to inform the design of the mHealth apps for this group of end-users.

There are only nine current mobile applications (described below) available to this group of users, which primarily focus on providing basic information about latest research, news, and practical tips on health, nutrition, and fitness, self-recording of health status, medication adherence, daily activities, symptoms, mood, and similar, and/or sharing the data with healthcare providers. Multiple Sclerosis Association of America (MSAA) released a mobile phone app for health self-reporting, My MS Manager, for individuals with MS and their caretakers [22]. Similarly, MS self app offers a journal that can be later easily accessed by the user who can share their data with the healthcare team [23]. Another self-reporting app is called MySidekick for MS [24], which also provides medicine reminders and a memory exercise. My MS Conversations provides an interactive group session with experienced virtual patients on selected topics [25]. MS Journal is an injection reminder tool for individuals with MS and their caregivers limited to UK market only [26]. My Multiple Sclerosis Diary [27] is another injection reminder mobile app that offers injection location and time set up. SymTrack was designed as a health self-reporting tool that stores shares the health charts with healthcare providers [28]. Social app MS Buddy [29] pairs individuals with MS with another person with MS to chat daily. MS Attack app [30] helps users learn about MS symptoms, how these present themselves during the MS attack and provides a location of the UT MS Clinic and the Neuro Eye Center.

These nine mobile apps provide only basic functionality with the limited set of features compared to the other health and wellness apps for the general population and individuals with other chronic conditions (e.g., iHealth mobile app provides telehealth [31], Headspace: Meditation app introduces the users to the practice of meditation [32], Mango mobile application gamified the medication adherence [33], Syandus provides simulation learning technology for patients and students [34]).

We conducted two formative studies [35][37] that assessed the usability and utility of the current mHealth apps to understand the existing state of the arts and provide the recommendations for the design of mobile health and wellness apps for individuals aging with MS. The two studies revealed that the current mHealth applications were not usable to the end-user population and did not provide holistic health and wellness support for the self-management of the condition. Hence, there is a need for a new evidence-based mobile application for people with MS, which would provide all the functional features that would help with the comprehensive health and wellness self-management and address their specific needs.

## III. MS ASSISTANT

MS Assistant is an evidence-based app, which provides the health and wellness self-management-based functionality, allows for personalization, assists with medication adherence and other daily tasks with alert and reminder systems, and sends alerts to the caregivers, family members, and healthcare providers in a case of an emergency. mHealth app was developed based on the results of the two formative studies [35][37] that evaluated the usability and utility of the current mHealth apps for individuals aging with MS. Its eight functions were selected based on the findings of a previously completed qualitative study [35], which was conducted to identify the specific needs for self-management of health and wellness among people aging with MS and to recognize the opportunities to meet those needs through mobile apps. The functions include *diary*, *reports*, *MS friends*, *games*, *education*, *goals*, *vitals*, and *emergency*. In addition, profile and settings were designed to offer personalization and customization.

### A. Functionality

*Diary* provides a comprehensive tool for understanding the disease on a daily basis and over time, and how best to manage it through everyday self-management tasks, such as mood, symptoms, energy level, activity, sleep length and quality, and diet. *Reports* allows users to compile their health management data into useful reports that can be shared electronically with healthcare providers and caregivers. *MS Friends* is a social support feature that connects users with other people with MS to share their experiences and everyday challenges. *Games* features VR games that would enable users to perform real-world activities that they might find challenging. In addition, this feature has cognitive and classic games that help people with MS with cognitive functioning, and physical games, which help them with the balance. *Education* provides the latest news and research



about MS as well as health and wellness tips. *Goals* enables users to set up their personal health and wellness goals to keep them motivated and inspired. *Vitals* offers remote health and wellness monitoring through the Bluetooth connected devices, such as blood pressure monitoring devices, scales, sleep and activity trackers (e.g., Fitbit), and similar. *Emergency* lets users place calls directly to their healthcare providers, caregivers, and emergency phone number (e.g., 911 in the USA).

The mHealth app sends alert messages to the caregivers, family members, and/or healthcare providers in a case of an emergency (i.e., when the values of certain vitals go above the threshold, such as blood pressure, self-reported depression, extreme values of the symptoms severity).

### B. Navigation

MS Assistant provides two types of navigation: linear and random access. Linear interaction allows users to go through the pages by making or skipping a selection and pressing the Next button. Users can go through the whole interface in a linear fashion by using the Next and Back buttons on every page, which provides consistency and simplicity. After a selection is made, the Next button takes users to the following page of the interface. When the user taps on any button, the button changes to the selected colored background and white text that visually emphasizes the selection. To change the selection, user can tap the button again to deselect it (Figure 1). Random access allows skipping the options and provides a faster pace of the navigation through the direct selection (Figure 2).

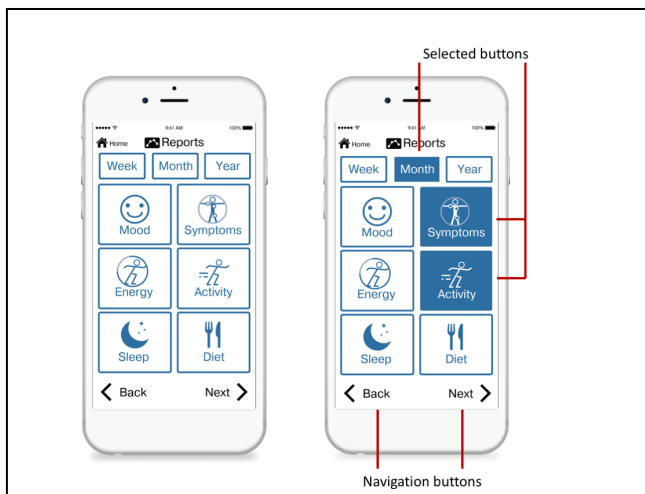

Figure 1. Linear navigation on Reports page.

### C. Design Decisions

MS Assistant was designed based on the Universal Design Mobile Interface Guidelines, UDMIG v.2.1 and corresponding design criteria, which has been previously reported [36]-[39]. For example, the design goal was one mobile app for all users, rather than accessible design for people with disabilities, and avoidance of specialized design and language (*Same means of use*). Consistent sequences of

actions are required in similar situations (*Consistency with expectations*). Complexity is eliminated by having simple screen designs that require a small number of tasks per screen (*Simple and natural use*).

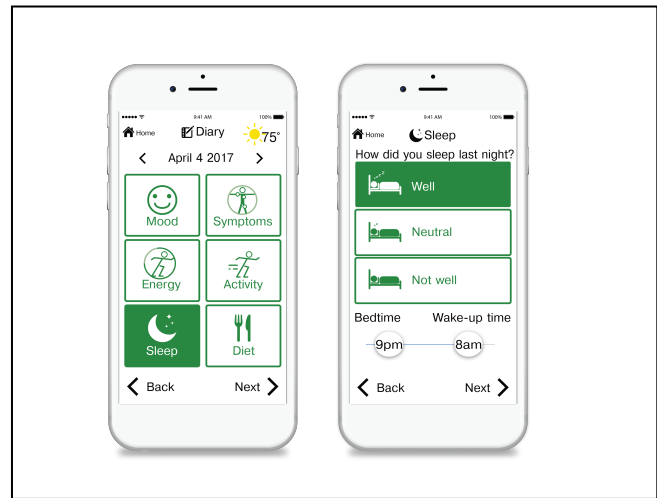

Figure 2. Random access on Diary page.

## IV. EVALUATION OF THE EFFECTIVENESS OF THE DESIGN FEATURES

For the purpose of evaluating the effectiveness of the design features as those were applied based on the UDMIG v.2.1 to the design of MS Assistant, we conducted an expert review in which expert evaluators rated the UDMIG-based design features that were implemented in MS Assistant, identified design elements that needed improvement, and recommended possible refinements. We collected user outcome measures, such as the ratings of the effectiveness of the application of the UDMIG design criteria to the app, and number and frequency of reported usability problems categorized based on their design features and characteristics. Additionally, we collected all verbally identified usability problems during the administration of the “talk aloud” protocol and categorized the data into the common themes to determine the main issues with the app [1][39].

### A. Methods

Ten researchers and/or designers with experience in aging, accessibility, human-computer interaction, human factors, industrial design, universal design, and/or usability participated in the study. Inclusion criteria were that participants be of age 18 and older and that they have more than three years of experience in one or more of the areas of expertise in accessibility, usability, aging, human factors, universal design, human-computer interaction, and/or industrial design. Participants’ expertise included accessibility (n=8), usability (n=8), aging (n=7), human factors (n=6), universal design (n=6), human-computer interaction (n=5), and industrial design (n=2) respectively. The mean number of years of their working experience was  $13 \pm 8.82$  years.



Experts rated their familiarity with the user interface design for people with MS, dexterity, cognitive, and visual limitations from being “not familiar” to “somewhat familiar” to “very familiar” (Table I).

TABLE I. RATINGS OF FAMILIARITY WITH THE USER INTERFACE DESIGN FOR PEOPLE WITH MS, DEXTERITY, COGNITIVE, AND VISUAL LIMITATIONS.

Familiarity with the user interface design for:	Not familiar	Somewhat familiar	Very familiar
People with MS	3	10	0
People with dexterity impairments	1	5	4
People with cognitive impairments	0	8	22
People with visual impairments	0	3	7

### 1) Procedures

After signing the informed consent form approved by the Georgia Tech IRB, experts completed a demographic questionnaire about their areas of expertise and a number of years they have worked in the field. Experts rated their familiarity with user interface design for people with MS, dexterity, cognitive, and visual limitations on a scale from “not familiar” to “somewhat familiar” to “very familiar.” They then performed directed tasks using MS Assistant without any training or assistance. Experts received a simple script with ten tasks that included entering health and wellness data (i.e., mood, symptoms and related difficulties, energy level, daily activity, sleep length and quality, and diet), emailing the reports, calling MS friend, finding virtual reality games, reading the MS news, setting up the weight goal, inputting the blood pressure, calling the healthcare provider, entering the personal information, and increasing the text size. Experts then used the UDMIG v.2.1 questionnaire to rate each guideline through its design characteristics, identified design elements needing improvement, and provided recommendations for their refinement.

#### a) UDMIG v.2.1 Design Criteria Questionnaire

Prescriptive design guidelines and standards are easy to interpret and to objectively assess. Assessment of performance guidelines is multidimensional since it incorporates both activity and participation [36]. All performance-based guidelines are subject to interpretation by experts as well as end-users to a certain extent, which makes objective measurement slightly difficult. UDMIG v.2.1 design criteria questionnaire rates agreement with achieving each of the design guidelines using the 5-point Likert scale where 1 = strongly disagree and 5 = strongly agree with each of the applicable design criteria. The versions of this questionnaire that correspond to the appropriate design criteria are intended to be used by end-users and to assist designers to think about the needs of the potential users who would interact with their mobile touchscreen applications.

The complete UDMIG v.2.1 design criteria questionnaire used for this expert review has 45 items (i.e., design criteria). An example of the questionnaire based on some of the design criteria (e.g., one design criteria per guideline) used for the expert review was previously published [35].

### 2) Data Collection and Analysis

We calculated the mean and standard deviation of the rating for each guideline and the mean and standard deviation of ratings for each participant. Fourteen ratings for one of the participants were excluded because they skipped the page with ratings of the guidelines.

Additionally, we analyzed the audio files during the participants’ use of MS Assistant and administration of the talk aloud protocol to extract more usability problems they encountered during the interaction with the app. We used an inductive approach for data analysis.

As primary researchers, two authors independently coded the transcripts and generated a preliminary set of codes. We coded for the themes (i.e., design features and related characteristics based on the identified problems) that participants reported in the UDMIG v.2.1 design criteria questionnaire. Another research team member then reviewed the sections of the transcript and associated codes. Next, we met to discuss the themes and refine the coding taxonomy. Labels (miscategorization), buttons (layout), keyboard (on-screen verification), too many clicks (physical effort), and lack of direction (navigation) were added themes. The coding had inter-rater reliability (i.e., Cohen’s kappa) of 79.0%. The team met again to discuss, further refine, and expand some of the themes and related categories. Buttons and pages (navigation) and layout of the buttons themes were expanded, and feature request, page layout (lack of consistency), and lack of confirmation of an activity (navigation) emerged as themes. For example, buttons and pages (navigation) included a problem with Next and Back buttons, in addition to other navigation problems participants talked about (e.g., confusion with going to the other News pages and suggestion to use “Page 1 of 2”). Moreover, the layout of the buttons theme incorporated the layout of the View Reports and Email Reports buttons category from the questionnaire in addition to the problems with the other buttons. We developed a list of themes, and each coder resampled an additional 20% of the data. Inter-rater reliability (i.e., Cohen’s kappa) of 81.0% was achieved between the two researchers.

### B. Results

The results reporting the effectiveness of the design features in MS Assistant, and the effectiveness of the mHealth app are detailed in this section.

#### 1) Effectiveness of the Design Features

*Ratings of the design features* as those were applied to the design of the mobile app following the UDMIG design criteria and *usability problems*, which were identified and reported by the expert users following each rating, are detailed in this section.

### a) Ratings of the Design Features

Ten participants rated 45 items on the UDMIG design criteria questionnaire. The total number of responses was 436, with 14 missing responses that were not used in the analyses. The range of ratings was 2 – 5 with the mean of all the ratings for design features was within a range of 3.90 (SD=1.10) – 4.89 (SD=0.33) (Table 36). Frequency of “Agree” and “Strongly Agree” ratings, which is a percentage of 4 and 5 ratings per design feature, was 60% - 100%. The design feature represented by DE6b (i.e., This app provides the system which can detect the error and offer a prompt message for handling it; if an entry for weight is skipped, provide a text message “Please enter a target weight”) had the lowest mean of the ratings equal to 3.90 and the lowest frequency of 4 and 5 ratings, F=60%. This was the only mean value for design criteria that was lower than 4. Participants stated that the app provided a prompt message for handling an error. However, the prompt should “offer options to submit data without all responses submitted.” Current prompts informed the users that they need to enter missing information and did not offer an option to skip certain fields. They made users fill out all the information on the page.

Out of a total of 436 ratings, 67% (n=292) of the design criteria was rated as 5 (“Strongly Agree”). An additional 27% (n=118) were rated as 4. The lowest rating for any criterion was 2 (1.3%, n=6) and an additional 4.6% (n=20) were rated as 3.

Among the 10 participants, mean ratings ranged from 3.87 – 4.91. The participant with the lowest overall mean ratings (M = 3.87) did not give a rating higher than 4 to any individual criterion with 39 rated as 4 and 5 rated as 3, and 1 as 2.

The mean values of the ratings were equal to 3.90 and above. Only one design feature had a mean rating of 3.90 (DE6b), and all other features had mean ratings of 4 and above. Therefore, expert users rated all design features highly usable in MS Assistant.

Design feature represented by DE6b “the system which can detect the error and offer a prompt message for handling it” was rated the lowest because some participants thought that the prompt informed the users that they need to enter missing information and did not offer an option to skip certain fields (N=4) and rated it very low (rating=2, N=1; rating=3, N=3). The second lowest mean rating was given to two design features because of the lack of tactile feedback in an app due to the lack of the Taptic Engine in iPhone 6 model (M=4.00). Two participants rated DE2a “feedback about a confirmation of my activity and a current state” low (rating=2, N=1, rating=3, N=1), and only one participant rated the design feature characterized by DE5a (i.e., different modes of feedback, such as sound or vibration) lower than 4 (rating=2, N=1). The next lowest mean rating was equal to 4.20 and was given to DE2b “system feedback for my actions, such as a beep when pressing a key,” due to the lack of the tactile feedback as well (rating=3, N=1). Two design features had mean rating of 4.22: IC8 “choice of linear navigation vs. random access” was rated by two participants lower (rating=2, N=1; ratings=3, N=1), and IC13b

“minimized steps (i.e., basic tasks)” was rated low by two participants (rating=3, N=2). Design feature represented by IC7b (i.e., the use of technical language is avoided) had mean rating of 4.33 (rating=2, N=1; ratings=3, N=1). All other mean ratings of the design features were equal to 4.40 and above.

The highest mean rating (M=4.89) was given to three design features: IC6d “cursive and decorative fonts and use of all uppercase letters are avoided,” IC9 “personalization to change my skill level from a “novice” to an “expert” user,” and IC10a “configuration of the display settings to my needs and preferences.” The second highest mean rating (M=4.80) was given to eight design features: DE1a “large enough button size,” DE4c “buttons in colors that stand out, and arranged in linear order,” DE6a “easy reversal of my actions if I make a mistake,” IC4a “the use of the picker is avoided,” IC4b “scrolling text, especially horizontal formats, is avoided,” IC5a “clear indication on the top of the page where the user currently is at any point of time,” IC14a “visible spacing between the small buttons,” and IC15 “main navigation buttons of equal importance at the bottom of the screen.”

The difference between the lowest mean rating (M=3.90) for DE6b and the highest mean rating (M=4.89) for IC6d, IC9, and IC10a was statistically significant ( $t(9)=2.951$ ,  $p=.016$ ). This result suggested a redesign of the prompt to allow users flexibility in navigation and an option to enter data they want, and not necessarily all data.

The second lowest mean rating (M=4.00) for two design features represented by DE2a and DE5a was significantly different than the highest mean rating (M=4.89) for IC6d ( $t(9)=2.667$ ,  $p1=.026$ ;  $t(9)=4.216$ ,  $p2=.002$ , respectively), IC9 ( $t(9)=2.667$ ,  $p1=.026$ ;  $t(9)=4.216$ ,  $p2=.002$ , respectively), and IC10a ( $t(9)=3.162$ ,  $p1=.012$ ;  $t(9)=4.216$ ,  $p2=.002$ , respectively). Both design features that correspond to DE2a and DE5a were rated lower due to the lack of tactile feedback. Participants would appreciate having vibratory feedback implemented within an app, but they understood the limitations of iPhone 6 models and the lack of the Taptic Engine. The next lowest mean rating (M=4.20) for DE2b and the highest mean rating (M=4.89) for IC6d, IC9, and IC10a ( $t(9)=2.981$ ,  $p=.015$ ) were significantly different as well. This design feature was rated low due to the lack of tactile feedback in iPhone 6 model as well.

There was a significant difference between the mean rating (M=4.22) for IC13b “minimized steps (i.e., basic tasks)” and the highest mean rating (M=4.89) for IC6d “cursive and decorative fonts and use of all uppercase letters are avoided” ( $t(9)=2.434$ ,  $p=.038$ ) and for IC9 “personalization to change my skill level from a “novice” to an “expert” user” ( $t(9)=2.434$ ,  $p=.038$ ), respectively.

### b) Usability Problems

After rating the design features, ten participants commented about the specific features and suggested design recommendations. We listed all usability problems with the app, grouped those issues into themes related to their design features and characteristics, and reported the number and frequency of participants reporting the problem (Table II).

Total of 3 participants (F=30%) reported low contrast on the instructions pages where white text on a grey background and “Do not show this again” button in a selected state with green text on a grey background did not provide high enough contrast (Table II).

*1. Navigation:* Seven participants reported problems with navigation due to having “to press on Next after a choice is made,” (P1) which “was not clear at first.” They either “expected to double click” (P6) or click on the selection to open that particular page. Moreover, 2 participants reported that “Next” and “Back” buttons look like a part of the specialized use and design. However, all of them understood that Next and Back buttons are typical of linear navigation, which is beneficial to an aging population that uses this app in a novice user mode only. Two participants were not sure whether there is more than one way to go to different pages (i.e., linear navigation using the Next and Back buttons and random-access).

*2. Labeling:* Labeling of buttons included a number of different usability problems and related suggestions. Four participants reported that “Education” should be renamed into “Digest,” “Resources,” or similar because “News” category did not belong in there. It was not clear that a healthcare provider would be listed under the functional feature named “Emergency” (N=2), but there was no agreement on the alternative location for it. P3 suggested that it should be moved under Reports as an additional sub-feature named Contacts. P1 stated they “didn’t want to click on it because I thought it would call 911,” but did not think any other location would be more suitable for it. Mood page had an “Energized” icon, which was confusing to 1 participant. Diary had a category “Energy level.” They suggested that “Anxious and Excited are missing” (P3) and that “Energized could be elsewhere.” Another suggestion was to rename “Input” and “Output” categories of Settings into a non-technical language (N=2). 1 participant reported that “Speech” should be renamed into “Voice.”

*3. Design of UI elements:* Design of a number of user interface elements included 3 participants who reported that Profile and Settings did not look like buttons (P9) and that those should be redesigned to “stand out” (P6) and look more prominent (P6, P9). Design in Adobe Illustrator presented in this paper followed the guidelines strictly and made a distinction between the name of the app, MS Assistant, and Profile and Settings buttons on the first page. However, because of the limitations of iOS and the size of the top navigation bar, there was no space for the Profile and Settings icons because of the minimum font size dictated by the UDMIG v.2.1. Participants suggested that those two buttons should “look like buttons” (P9) with possibly adding a black border to them, relevant icons, or background color so that those look like the other buttons on the home page. In addition, 2 participants reported that top navigation bar icons that represent a title of the current page, including the weather icon, “look clickable” (P6). During the design phase, Adobe Illustrator prototypes made a clear distinction between the design of the home button and the title of the current page (e.g., Diary, Mood, Vitals). However, since the iOS limited the size of the top navigation bar and there was

no compromise on the side of the font size, those two looked the same. P4 recommended that “header should look different than the home button.” Moreover, 2 participants commented that the design of the slider used on the symptoms, difficulties, and sleep pages probably needs a redesign because of the problems with motor control in individuals with MS, and their possible use of the stylus. 1 participant commented that the “numbers on the bottom should be on top of the slider” (P9).

*4. Buttons:* Three participants reported a lack of vibration while tapping the buttons even though they understood the limitations of iPhone 6 due to the lack of the Taptic Engine, which provides the vibration while tapping the buttons that was included in later iPhone versions. P6 “expected to double-click” (N=1). However, the single tap was implemented throughout the app due to the design criteria IC13a (i.e., Use a single tap throughout the app instead of double-clicking).

*5. Keyboard:* One participant reported that spell check should be provided with the use of a keyboard. Lack of page scrolling while using a keyboard was found problematic to 2 participants. Participants recommended to “add scrolling where additional input is needed.” Scrolling was disabled throughout the interface because of the IC4c design criteria requirement.

*6. Page layout:* Total of three participants had problems with the page layout. For example, P5 reported that “View Reports” button should be placed above the “Email Reports” button (N=1). Two participants reported that spacing between the top navigation bar and large buttons (e.g., Manual entry, Week, Month, Year buttons) should be increased.

*7. Contrast:* Two participants reported 3 times low contrast on the Instructions pages during the use of the app.

*8. Prompt:* Two participants reported that “Sometimes (it is) not clear what info is missing but did get a general message about missing info” (P5) after getting the prompt message, and that the app should “offer options to submit data without all responses submitted” (P7).

*9. Font size:* One participant thought that the font size of the News articles was too small.

## 2) Effectiveness of the app

While using MS Assistant, participants verbally identified specific *usability problems*, and *positive aspects* of MS Assistant via “talk aloud” protocol and in some cases recommended design solutions. Audio transcripts were used to identify usability problems and positive feedback.

### a) Usability Problems

We categorized all the issues with the app into the themes to identify usability problems, and we reported related design features and their characteristics (Table III).

*1. Navigation:* Seven participants reported 12 times problems with navigation due to having to press on Next after a single choice is made and the appearance of Next and Back buttons as specialized use.

*2. Labeling:* Labeling of a total of eight buttons was not clear to a number of participants. Seven participants reported

7 times that “News” category did not belong in “Education” and that it should be renamed. It was not clear to 2 participants that a healthcare provider would be listed under the “Emergency” (n=2), but they could not think of an alternative location for it. Two participants thought that an “Energized” icon on the Mood page was confusing because Diary had a category called “Energy level” (n=2). Their suggestion for a replacement was to name it “Excited.” Seven participants stated 9 times that “Input” and “Output” categories in Settings sound as a technical language and that those would be confusing to a regular user. Four participants thought that “Speech” should be renamed into “Voice” (n=4). In addition to these relabeling suggestions reported with the UDMIG v.21. questionnaire, there were 3 more labels reported during the interaction with the app. One participant suggested once to rename “News” into “MS News,” another proposed once to rename “Diary” into “Daily feelings” or “Daily something” (P6), and the third one recommended to rename “Do not show this again” button into “Hide” (P10).

**3. Design of UI elements:** Participants had problems with the design of 5 user interface elements, which is 2 more than reported in the questionnaire. Five of them stated that Profile and Settings did not look like buttons and suggested to redesigned them to look more prominent and like buttons by adding a black border around them, icons, and/or a background color (n=5). Three participants thought that the top navigation bar icons that have a function of a header look like buttons (n=4). Five participants commented 7 times that the design of the slider should be changed. P3 and P6 thought that an easier design element should be used instead because the individuals with MS would have problems using it due to their limitations with motor control and the use of the stylus. P9 thought that the numbers on the slider should be on top of it, and P10 suggested to change the font of the selected number compared to the range provided (i.e., 1 to 5). In addition to these design elements present in the results based on the questionnaire, 3 participants reported 5 times problems with the design of the icons. For example, Output icon in Settings looked like a sound (P5) and audio (P9), P9 suggested to replace Input icon with Speech icon and to change Speech icon itself, and P10 stated that Seeing icon in Difficulties looks happy and that it should be changed. Moreover, P9 commented once that the comment section for MS type was not visible and that it could be replaced with a drop-down menu offering the names and abbreviations of the four types of MS.

**4. Page layout:** The total number of 6 participants commented 13 times about the problems with the layout of the buttons, including View Reports and Email Reports buttons. Two participants reported that the View Reports button should be above Email Reports button (n=2). In addition to the layout of the Email/View Reports buttons, 5 participants reported 11 problems with the layout of other buttons. For example, P3 thought that Tips would be of great importance and interest to the target population, and that Tips should be placed first on the list, followed by News and Research. They and P7 suggested having the listing of all the headlines of the articles on the News page. Week, Month,

and Year buttons on the Reports page were not clear at first to this participant, and P6 suggested to “maybe change the color of the (Week,) Month, Year buttons.” P4 suggested placing the “Read more” button on the News page on the bottom of the page. P10 said that the “names for the games are too long” and that we should “maybe change the layout to vertical buttons.” They thought that “overall, the design is nice, but I would make it more dynamic.” This participant did not understand the sequence on the 2 by 3 layout of the buttons on the Symptoms page. They thought that “if meditation (button) moves from the first place after a certain amount of (usage) time, would that be confusing?” in a case of a smart app. Reports pages should have “Page 1 of 2” on them. The small spacing between certain buttons (e.g., the Manual button in Vitals and Week, Month, Year buttons in Reports) and the top navigation bar was reported by 4 participants (n=4).

**5. Keyboard:** Five participants reported lack of page scrolling while using a keyboard 6 times.

**6. Prompt:** Three participants stated 4 times that when missing to fill out all the data on one page, the corresponding prompt makes them fill out all the information and lacks the flexibility to offer them the option to submit data without submitting all the responses. P10 suggested changing the text of the prompt to “Are you sure you want to skip X and Y?” The font size of the News articles was too small to 2 participants (n=2).

**7. Other:** Two participants thought that the font size of the News articles was too small. Two participants reported 3 times low contrast on the Instructions pages during the use of the app. One participant thought that the drawback of using a single tap is that it requires too many steps. P10 complained that the app requires too many clicks and that they are “wondering how much effort I am saving” (n=1).

**8. Additional usability problems:** Additionally, there are 6 themes of problems identified during the interaction with the app, which were not reported on the questionnaire. Six participants requested 11 times that certain features could benefit the app. For example, P1 asked if there is any way to specify the body area in Difficulties. P3 suggested that in a case of two selections in Symptoms, after making the one selection the app takes you to that symptom’s page, and then it takes you to the one-screen selection again to make the second one. They added that the weight goals should have displayed the user’s current weight with the text “This is what your weight is right now.” P5 requested a louder sound feedback with the use of the buttons, adding the MS experience within the Profile, adding the Resources to the list of News, Research, and Tips because “older adults don’t know where to find resources,” and adding the info box to the View Reports page that would say “Select one or more buttons and choose whether you want Reports.” P6 suggested to have the option to check the email address of the person who would get the reports sent by the user, to “make it clear in the description of a friend who he/she is by listing the symptoms or something else” in MS Friends, and to clarify on the top of the Instruction page “what this page is” by possibly adding “Getting started”. P7 thought that after the prompt about sharing the personal information, Profile

page should have that information written again on the top of the page. P10 commented that in MS Friends “I would expect something about Mike to show up in a case of two people with the same name.”

Five participants commented 10 times about the miscategorization of the certain labels. For example, P1 did not know where to enter data for numbness and where to find personal information. P6 thought that “Medications should be separate; not under Profile.” P7 commented that it is “not intuitive” to look for “non-emergency contacts under Emergency; Emergency is 911”, and that this “call should go under MS Friends.” P9 “was not sure if Difficulty was on another page” and thought that Personal Information “would probably be in Diary.” P10 added that “I would go to Diary for my Mood, symptoms. For energy level, because it is quantitative data, I would go to Reports.” This participant stated that “I wouldn’t link difficulty to symptoms.” When looking for Reports, P10 said that “I could think also whether to go to MS Friends.” P10 was not sure where to call a doctor, but after thinking about the available features, they thought that “Emergency and MS Friends makes sense.”

Two participants reported lack of consistency in the page layout 2 times regarding the selections on two pages in the View Reports and Email Reports. P9 said that on-screen keyboard is problematic with verification because “I was looking for a back button. I don’t see any indication that the focus is there (keyboard).”

Buttons and pages (navigation) theme was present 12 times in 6 participants. For example, P3 suggested that in the case of multiple selections, one at a time can be selected with a “loopback for more.” P4 commented that it is “confusing to go from Symptoms to other screens if I want to skip something” and wondered if it is better “to go to the Home page from Symptoms or to go through all unwanted pages.” They did not understand that Diary page offered random-access. The same participant complained that “when I went to Activity, Back (button) is taking me to the main (Diary) menu instead to Energy,” which happened because the participant directly selected Activity from the Diary page. P5 thought that by tapping on the Next button on the News page, they were “going to the next page.” This participant was not sure if they selected Mood “it would take me through everything,” asked why Symptoms and Difficulties are not at the same level because these “are the same,” and thought that “it should be clear there is no scrolling because of Back and Next buttons.” P6 thought that we should “add another meal page after you go through one.” P9 was confused that there is no “choice of eggs on the same page (with bread),” when both bread and eggs were selected. P10 commented when opened Diary Instructions page:

*“I see a screen with a lot of text on it. When I first click on Diary, I would expect an input box. I see it’s a prompt, but it doesn’t look like a prompt.”*

The same participants thought that the comment section on the Symptoms page was not clear:

*“I wouldn’t think to put that information in here. I would enter numbness related to arm in one log, and for legs in another. Not both in one.”*

P10 also thought that “Email Reports would email reports by pressing (it).” The same participants reported a lack of confirmation of activity after entering the data on the Symptoms page (n=1).

#### *b) Positive Feedback*

Participants had some positive feedback throughout their usage of the app. P3, P4, and P10 loved the icons, which made sense to them and looked “expressive.” P3 liked the sound feedback with the slider and with a tap on the buttons. Settings had a “pretty good mix there.” P4, P6, and P7 liked “the color scheme a lot” (P6). P4 liked the font size. P4 and P8 appreciated the ability to deselect information which would be shared by using the switches on the Personal Information page, and P5 liked that on the switches have green color when selected because “green means go, so I guess green means sharing,” and that there was a confirmation message (i.e., prompt) “especially when I was sharing the information.” P4 commented that the “buttons are refreshingly large,” how “it is nice that it (linear interface) is making me log in everything this way,” and that the app was “nice and easy to use.” Both P5 and P6 appreciated that the user could choose from many items and make multiple selections on View Reports and Email Reports pages. P6 and P10 liked the design of the Sleep page, and P10 commented:

*“I like the Sleep screen. It saved me a click. Once I am done, the screen itself looks like a confirmation. This screen is more confirmative to me than a Symptoms screen.”*

P10 thought that the Diet pages were designed consistent with the linear interface and that “if I am eating two different things I would not expect that Next would take me to both selections (on one page). It is pretty linear, the app, so I wouldn’t expect that.” The same participants thought that “Energy screen is really good and clear,” and that “the slide bar is really good because the slider is big.” P10 added that:

*“Back and Home (buttons) both take me to the Home page, which is good. Home is a reference point. I would press Home button to go to the Home page.”*

P6 and P8 liked that there was a prompt before emailing the reports asking if the user wanted to email selected reports to selected contacts. P8 thought that “Reports is a great feature,” because the user “can decide what I am going to let them know. I am not going to let them know about my diet because I had a lot of bacon.” P6, P7, P8, and P10 thought that MS Friends is a nice and “straightforward” (P10) feature, on which P6 commented:

*“I really like the idea that they can connect with people with MS.”*

P6 liked having the RPM via Bluetooth in Vitals. Games were “clear and easy to find” to P6 and “very simple” to P10. P8 thought that “this is going to be very cool. I like the News.”

P6 commented on the overall design of the app:

*“I like it. I like the nice simple design with large icons. It is easy to read. It has very nice feeling about so that I want to use it. It is nice. It looks like it can be useful.”*

P7 thought of MS Assistant as a consistent app with a great display:

*“From UD perspective, it is really well done.”*

P8 thought that MS Assistant “is very well designed,” it offers flexibility and a choice, and further commented:

*“I think this is fabulous. Enormous utility. It is incredibly thought out. I love this.”*

P9 liked Home button and thought that the app was “very consistent” and “for someone with learning cognitive disability, it is accessible,” and added:

*“This is better than most apps that I have experienced. I am impressed.”*

### C. Design Implications

As expected, audio transcripts revealed some additional usability problems reported by the participants and the existing problems were reported by a larger number of participants verbally, except in the case of the issues with the color contrast.

Overall, the main usability problems were labeling of the buttons, use of Next and Back buttons for the linear navigation, design of a number of UI elements, lack of page scrolling with the use of a keyboard, layout of a number of the buttons, certain feature requests, miscategorization of a number of labels, and navigation related to the design of the buttons and pages. For example, problems with the labels for “Education,” “Emergency,” “Input,” and “Output” buttons were reported by a majority of the participants (Appendix D). Labeling of the “Speech” button was reported by 40% of the participants and labeling of the “Energized” button on the Mood page was reported by 20% of the participants. Additionally, participants commented unfavorably on the use of Next and Back buttons for the linear navigation. However, they understood that the linear navigation using these two buttons might be more usable for the aging population of users. Moreover, they acknowledged that the smart interface and an option to switch from novice to expert user skips this way of the navigation for the more tech-savvy users. Design of certain UI elements was reported as well. For example, Profile and Settings did not look like buttons and the slider needed to be redesigned to half of the participants. Thirty percent of participants reported that Header looked like a button and that certain icons needed to be redesigned. Additionally, half of the participants reported that the page scrolling should be present while using the keyboard. Sixty percent of participants reported that the layout of the buttons needed to be changed (e.g., locations of Email Reports and View Reports buttons should be switched). Additionally, 40% of them thought that the spacing between the top buttons (e.g., Manual input button in Vitals, Week, Month, Year buttons in Reports) and the buttons below should be increased. Total of 30% of participants thought that after missing to fill out all the fields on one page, the prompt that follows should give them two options. First, it should let them go back to the previous page to fill out the missing content. Alternatively, it should allow them to go to the following page and leave certain fields empty. 20% of the participants stated that the font size of the MS News articles was small. In addition, 20% of the participants reported on the UDMIG v.2.1 questionnaire only that it was not clear

that they can navigate through the whole interface in a linear fashion using the Next and Back buttons.

There were a number of problems that were found on the audio transcripts, which were not reported on the questionnaire. For example, 60% of participants thought that the app would benefit from the additional features (e.g., a place to specify the body area in Difficulties, the user’s current weight with the text “This is what your weight is right now” in the weight goals, a louder sound feedback with the use of the buttons). Miscategorization of certain labels was a problem to half of the participants. Sixty percent of the participants reported problems with navigation due to the lack of direction, page design, and multiple selections. Additionally, 20% of the participants reported a lack of consistency on a page layout due to two pages with multiple selections within Reports.

Moreover, there were a number of problems that were reported by only one participant. For example, labeling of “News,” “Diary,” and “Do not show this again” was not clear to 1 participant per label. These problems were not addressed in the app redesign section, except for the “Do not show this again” button, which was renamed into “Hide this page.” Design of UI elements category had the additional problems with the design of an input field for the MS type in Personal Information within the Profile (n=1). Problem with the keyboard spell check was not present in the audio transcripts, and one participant reported it on a questionnaire. One participant reported that the interface requires too many clicks. Although the app provides an on-screen verification within the input field, the lack of it was reported by 1 participant. Additionally, lack of confirmation of activity was reported once.

## V. REFINEMENT OF MS ASSISTANT

All the design features and related characteristics that needed to be redesigned based on the results of both the UDMIG v.2.1 design criteria questionnaire and audio transcripts were summarized, as previously reported [1]. The rationale for the design response was to make a design change if in agreement with UDMIG v.2.1, if at least two participants reported the problem, and if the suggestions were not already present in the prototype of MS Assistant.

Dark grey background on the instruction pages was changed into white to provide more contrast against the black and green (i.e., confirmation) text (Figure 3). “Education” was renamed into “Resources”, “Emergency” into “Emergency Contacts” (Figure 4), “Energized” (in Mood) into “Excited”, “Input” into “Speech Input”, “Touch” into “Touch Input”, “Output” into “Display and Sound”, and “Speech” was replaced with “Voice”.

Due to the lack of space on the top navigation bar, the name of the app, MS Assistant, was taken out of the Home page and the icons for Profile and Settings were added (Figure 4). The color of the icons for the current state (e.g., Diary, Reports) was changed from black into the color of that function (e.g., Diary icon in green, Reports icon in blue). In this way, the icon and the header look like the part of the page background and not like the buttons (Figure 3).

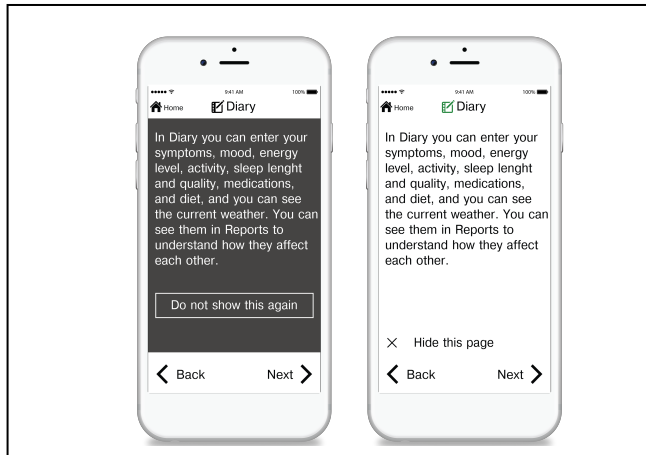

Figure 3. Before (left) and after (right) Diary Instruction page

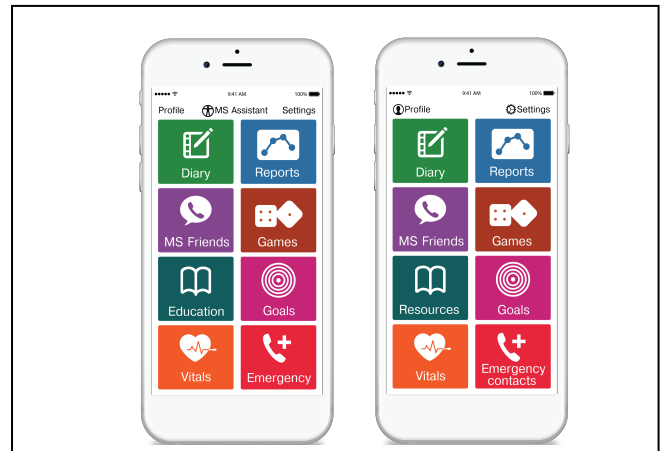

Figure 4. Before (left) and after (right) Home page

TABLE II. DESIGN FEATURES AND CHARACTERISTICS RELATED TO THE IDENTIFIED USABILITY PROBLEMS

Themes	Usability Problems	Design Feature and Related Characteristic		Ability Required to Perform the Task	Number and Frequency of Participants, N, F (%)
Navigation	Not clear whether a required action was taken due to having to press Next after a single choice is made	Next and Back buttons, Navigation		Cognitive	N=7 F=70%
	Lack of understanding that there are two ways of navigation	Two ways of navigation, Navigation			N=2 F=20%
Labeling	Not clear labeling of buttons	Buttons, Labeling	Education	Visual	N=4 F=40%
			Emergency		N=2 F=20%
			Energized		N=1 F=10%
			Input, Output		N=2 F=22.22%
			Speech		N=1 F=10%
Design of UI elements	Profile and Settings buttons not prominent and visible	UI elements, Design	Profile and Settings	Visual	N=3 F=30%
	Header looks like a button		Header		N=3 F=30%
	Slider hard to use by the target population, the font and location of the numbers		Slider	Physical/ Visual	N=2 F=20%
Buttons	Lack of vibration	Buttons, Haptic feedback		Physical	N=3 F=30%
	Expected double-tap	Buttons, Single tap			N=1 F=11.11%
Keyboard	Lack of page scrolling with use of a keyboard	Keyboard, Page scrolling		Physical	N=2 F=20%
	Lack of spell check with the use of a keyboard	Keyboard, spell check			N=1 F=10%
Page layout	Small spacing between the buttons	Button spacing, Layout		Visual	N=2 F=20%
	Layout, form, and location of View/Email Report buttons	View and Email Report buttons, Layout			N=1 F=10%
Contrast	Low contrast against the background (instruction page)	Background, Contrast		Visual	N=3 F=30%
Prompt	Lack of specificity and lack of flexibility (navigation)	Prompt, Content			Cognitive
Font size	Small font size	Text, Font size		Visual	N=1 F=11.11%



TABLE III. USABILITY PROBLEMS (I.E., THEMES AND PROBLEM EXPLANATIONS) WITH RELATED DESIGN FEATURES AND CHARACTERISTICS

Themes	Usability Problems	Design Feature and Related Characteristic		Ability Required to Perform the Task	Number of Instances Problem was reported, n	Number of Participants, N
Navigation	Not clear whether a required action was taken due to having to press Next after a single choice is made; Specialized use	Next and Back buttons, Navigation		Cognitive	12	N=7
Labeling	Not clear labeling of buttons	Buttons, Labeling	Education		7	N=7
			Emergency		7	N=7
			Energized		2	N=2
			Input, Output		9	N=7
			Speech		4	N=4
			News		1	N=1
			Diary		1	N=1
	Do not show this again		1	N=1		
Design of UI elements	Profile and Settings buttons not prominent and visible;	UI elements, design (form and color)	Profile, Settings	Visual	5	N=5
	The header looks like a button;		Header		4	N=3
	Slider hard to use by the target population, the font and location of the numbers;		Slider	Physical/ Visual	7	N=5
	Not adequate icons;		Icons	Cognitive	5	N=3
	Lack of MS types options		MS type		1	N=1
Page layout	Layout, form, and location of the buttons (including View/Email Report buttons); Page layout; Missing information about the selection and navigation; not dynamic enough; smart app feature	Buttons, Page Layout			13	N=6
	Too small button spacing	Button spacing, Layout		Visual	4	N=4
Keyboard	Lack of page scrolling with use of a keyboard	Keyboard, Page scrolling		Physical	6	N=5
Prompt	Lack of flexibility (navigation)	Prompt, Content		Cognitive	4	N=3
Font size	Small font size	Text, font size		Visual	2	N=2
Contrast	Low contrast against the background	Background, Contrast			3	N=2
Single tap	Too many clicks required (physical effort)	Buttons, Single tap		Physical	1	N=1
Feature request	Missing features	Feature, Feature request		Cognitive	11	N=6
Navigation	Lack of direction; Page design; Multiple selections	Buttons and pages, Navigation			12	N=6
Design	Wrong location and labeling of certain features	Labels, Miscategorization			10	N=5
Lack of consistency	Lack of consistency in page layout	Page layout, Lack of consistency			2	N=2
Keyboard	Lack of the on-screen verification with keyboard	Keyboard, On-screen verification			1	N=1
Lack of confirmation	Lack of confirmation that data was entered	Lack of confirmation of activity, Navigation			1	N=1

Numbers on the slider were placed on the top of it. Speech icon was replaced with Output icon, and Input icon with Speech icon. Output icon and Seeing icon (in Difficulties) were redesigned. Even though only one participant reported that there was no spell check with the use of a keyboard, this general feature was implemented because it is present in a majority of the apps. Page scrolling was added with the use of a keyboard. A prompt was redesigned to inform about the missing data in a way that allows users to go to the following page without having to fill out all information (i.e., "Do you want to fill out the missing information?" with Yes that takes them back to the previous page, and No that takes them to the following page). Text about the navigation (i.e., linear navigation using Next and Back buttons) was added to the first instruction page. The font size of the MS News articles was increased. The layout of the buttons was changed (e.g., View Report button was moved above the Email Report button, and the names of the VR games were shortened). The other layout changes were not made due to the inconsistencies with the page layout. A spacing between the top buttons and large buttons below (e.g., Manual entry, and Week, Month, Year buttons) was increased. There were a number of feature requests. For example, additional information about MS Friends is added on the calling page (e.g., friend's interests, MS type, and other information the person wants to share). No changes were made to the other feature requests due to the small number of participants reporting the problem (N=1 per problem).

Seven participants were reporting a problem with the navigation using Next and Back buttons. However, no change was made due to the design criteria IC2d. (i.e., Have more than one way to go to different pages while keeping the consistency). Next and Back buttons are typical of linear navigation and will be used in the novice user mode only. Additionally, 3 participants did not see that this prototype included alternative voices within the Settings and a problem with it. Similarly, 3 participants reported problems with the lack of the tactile feedback, which was not incorporated because iPhone 6 does not have the Taptic Engine that provides the vibration while tapping the buttons that was included in later versions. The total number of participants reporting the problems with the miscategorization of the labels was 5. However, no changes were made due to the small number of participants reporting the individual problem (N=1 per problem). No change was made to the second page of the Reports due to the lack of page space (N=2). Even though there was a total of 6 participants who reported a problem with the navigation due to the design of the buttons and pages, no changes were made due to the small number of participants reporting the specific problem (N=1 per problem).

## VI. CONCLUSION AND FUTURE WORK

This research paper provides a detailed evaluation of the usability of MS Assistant by expert reviewers, which was previously reported [1]. The results of the expert review confirm the effectiveness of the UDMIG v.2.1 within the application to MS Assistant. Overall, this implementation of

the guidelines to the design of the mobile app scored well. Most of the participants favorably agreed that the guidelines were effective. Ninety percent of the mean values of the participants' ratings were equal to 4 or higher. In addition, there was a small number of recommendations related to the minor usability problems in MS Assistant. Design changes addressed the usability-related suggestions made by the expert reviewers. One of the drawbacks of the study was its small sample size. However, all the experts had extensive and wide expertise applicable to the design of mHealth apps for people aging with disabilities. Another drawback of the study was that none of the experts was "very familiar" with the design of user interfaces for the target population. However, the majority of them were "somewhat familiar" with it.

Future work will include usability testing of the mHealth app with the individuals aging with MS to understand the usability of MS Assistant to determine the effectiveness of UDMIG v.2.1 in producing a universally usable product. This study will help with the analysis of the user-specific preferences for the specific design features and the resulting design implications.

## ACKNOWLEDGMENT

This research was partially supported by a grant from the National Institute on Disability, Independent Living, and Rehabilitation Research (NIDILRR grant number 90RE5016-01-00) under the auspices of The Rehabilitation Engineering Research Center on Technologies to Support Successful Aging with Disability (RERC TechSAge). NIDILRR is a Center within the Administration for Community Living (ACL), Department of Health and Human Services (HHS).

## REFERENCES

- [1] L. Ruzic, H. P. Mahajan, and J. A. Sanford, "Universally Designed mHealth App for Individuals Aging with Multiple Sclerosis," The Third International Conference on Universal Accessibility in the Internet of Things and Smart Environments (SMART ACCESSIBILITY 2018), Mar. 2018.
- [2] H. Moses, M. Picone, and V. Smith, Clinician's primer on multiple sclerosis: An in-depth overview. CMC, 2008.
- [3] R. Fraser et al., "Self-management for People with Multiple Sclerosis: Report from The First International Consensus Conference, November 15, 2010," International Journal of MS Care, vol. 15, pp. 99-106, 2013.
- [4] E. E. Gulick, "Symptom and activities of daily living trajectory in multiple sclerosis: a 10-year study," Nursing Research, vol. 47, pp. 137-14, 1998.
- [5] W. E. Fleming and C. P. Pollak, "Sleep disorders in multiple sclerosis," Seminars in Neurology, pp. 64-68, 2005.
- [6] M. Finlayson, "Health and social profile of older adults with MS: Findings from three studies," International Journal of MS Care, vol. 4, pp. 139-151, 2002.
- [7] T. DiLorenzo, "Aging with Multiple Sclerosis," Clinical Bulletin, Information for Health Professionals, pp. 1-9, 2011.
- [8] A. D. Rae-Grant et al., "Self-management in neurological disorders: systematic review of the literature and potential interventions in multiple sclerosis care," Journal of Rehabilitation Research and Development, vol. 48, pp. 1087, 2011.

- [9] M. Bishop and M. Frain, "Development and initial analysis of multiple sclerosis self-management scale," *International journal of MS care*, vol. 9, pp. 35-42, 2007.
- [10] C. H. Bombardier, M. Cunniffe, R. Wadhvani, L. E. Gibbons, K. D. Blake, and G. H. Kraft, "The efficacy of telephone counseling for health promotion in people with multiple sclerosis: a randomized controlled trial," *Archives of physical medicine and rehabilitation*, vol. 89, pp. 1849-1856, 2008.
- [11] E. S. Knaster, K. M. Yorkston, K. Johnson, K. A. McMullen, and D. M. Ehde, "Perspectives on self-management in multiple sclerosis: a focus group study," *International journal of MS care*, vol. 13, pp. 146-152, 2011.
- [12] A. K. Stuijbergen, H. Becker, S. Blozis, G. Timmerman, and V. Kullberg, "A randomized clinical trial of a wellness intervention for women with multiple sclerosis," *Archives of physical medicine and rehabilitation*, vol. 84, pp. 467-476, 2003.
- [13] P. Rompani and T. Dua, *Atlas: Multiple sclerosis resources in the world 2008*. WHO Press, World Health Organization, 2008.
- [14] M. Finlayson, K. Preissner, C. Cho, and M. Plow, "Randomized trial of a teleconference-delivered fatigue management program for people with multiple sclerosis," *Multiple Sclerosis Journal*, vol. 17, pp. 1130-1140, 2011.
- [15] D. C. Mohr et al., "Telephone-administered psychotherapy for depression. *Archives of General Psychiatry*," vol. 62, pp. 1007-1014, 2005.
- [16] D. C. Mohr et al., "Telephone-administered cognitive-behavioral therapy for the treatment of depressive symptoms in multiple sclerosis," *Journal of consulting and clinical psychology*, vol. 68, pp. 356, 2000.
- [17] M. Ploughman et al., "Factors influencing healthy aging with multiple sclerosis: a qualitative study," *Disability and rehabilitation*, vol. 34, pp. 26-33, 2012.
- [18] D. M. Zulman et al., "How can eHealth technology address challenges related to multimorbidity? Perspectives from patients with multiple chronic conditions," *Journal of General Internal Medicine*, vol. 30, pp. 1063-1070, 2015.
- [19] R. Haase, T. Schultheiss, R. Kempcke, K. Thomas, and T. Ziemssen, "Use and acceptance of electronic communication by patients with multiple sclerosis: a multicenter questionnaire study," *Journal of Medical Internet Research*, vol. 14, pp. e135, 2012.
- [20] K. Van Kessel, D. R. Babbage, N. Reay, W. M. Miner-Williams, and P. Kersten, "Mobile technology use by people experiencing multiple sclerosis fatigue: Survey methodology," *JMIR mHealth and uHealth* vol. 5, e6, 2017.
- [21] M. R. Ann, A. R. Salter, T. Tyry, R. J. Fox, and G. R. Cutter, "Preferred sources of health information in persons with multiple sclerosis: degree of trust and information sought," *Journal of Medical Internet Research* vol. 15, e67, 2013.
- [22] My MS Manager. Access date: 10/03/2018. [Online]. Available: <https://mysaa.org/msaa-community/mobile/>
- [23] MS self™, the Multiple Sclerosis Mobile App. Access date: 10/03/2018. [Online]. Available: <http://www.moveoverms.org/multiple-sclerosis-app-ms-self/>
- [24] MySidekick for MS. Access date: 10/03/2018. [Online]. Available: [https://www.abovems.com/en\\_us/home/resources/ms-tools-services/mysidekick-app.html](https://www.abovems.com/en_us/home/resources/ms-tools-services/mysidekick-app.html)
- [25] My MS Conversations™. Access date: 10/03/2018. [Online]. Available: [https://play.google.com/store/apps/details?id=com.syandus.ms\\_patiented\\_01&hl=en](https://play.google.com/store/apps/details?id=com.syandus.ms_patiented_01&hl=en)
- [26] MS Journal. Access date: 10/03/2018. [Online]. Available: <https://itunes.apple.com/us/app/ms-journal/id523663325?mt=8>
- [27] My Multiple Sclerosis Diary. Access date: 10/03/2018. [Online]. Available: <https://play.google.com/store/apps/details?id=com.appxient.mymsdiary&hl=en>
- [28] SymTrack. Access date: 10/03/2018. [Online]. Available: <http://www.symtrac.com/>
- [29] MS Buddy. Access date: 10/03/2018. [Online]. Available: [https://play.google.com/store/apps/details?id=com.healthline.ms\\_buddy](https://play.google.com/store/apps/details?id=com.healthline.ms_buddy)
- [30] MS Attack. Access date: 10/03/2018. [Online]. Available: <https://play.google.com/store/apps/details?id=com.cloudninedevelopmentllc.MSAttack&hl=en>
- [31] iHealth. Access date: 10/03/2018. [Online]. Available: <https://ihealthlabs.com/>
- [32] Headspace: Meditation. Access date: 10/03/2018. [Online]. Available: <https://www.headspace.com/headspace-meditation-app>
- [33] Mango. Access date: 10/03/2018. [Online]. Available: <https://www.mangohealth.com/>
- [34] Syandus. Access date: 10/03/2018. [Online]. Available: <https://www.syandus.com/>
- [35] L. Ruzic and J. A. Sanford, "Needs Assessment - mHealth Applications for People Aging with Multiple Sclerosis," *Journal of Healthcare Informatics Research*, pp. 1-28, 2017.
- [36] L. Ruzic and J. A. Sanford, "Universal design mobile interface guidelines (UDMIG) for an aging population," in *Mobile e-Health*, pp. 17-37, 2017.
- [37] L. Ruzic and J. A. Sanford, "Usability of mobile consumer applications for individuals aging with Multiple Sclerosis," *Proc. 9<sup>th</sup> International Conference on Universal Access in Human-Computer Interaction (HCI2017)*, Springer, Jan. 2017, pp. 258-276.
- [38] L. Ruzic, C. N. Harrington, and J. A. Sanford, "Design and evaluation of mobile interfaces for an aging population," *The Tenth International Conference on Advances in Computer-Human Interactions (ACHI2017)*, Mar. 2017, pp. 305-309, ISBN: 978-1-61208-538-8
- [39] L. Ruzic, C. N. Harrington, and J. A. Sanford, "Universal Design Mobile Interface Guidelines for mobile health and wellness apps for an aging population including people aging with disabilities," *International Journal on Advances in Software*, vol. 10, pp. 372-384, 2017.

# Achieving Good Worklife Ergonomics in eHealth Co-Creation

- The 'What', the 'Why' and the 'How'

Niels Frederik Garmann-Johnsen<sup>1,2</sup>, Migle Helmersen<sup>1</sup>

<sup>1</sup>NORCE research,  
Kristiansand, Norway  
Emails: {ngar, mihe}@norceresearch.no

Tom Roar Eikebrokk<sup>2</sup>  
<sup>2</sup>Dept. of Information Systems,  
University of Agder  
Kristiansand, Norway  
Email: tom.eikebrokk@uia.no

**Abstract**—Service improvement ['servitization'] and digitalization are two megatrends that affect healthcare and public services along with other sectors in general. A new model is needed to prescribe how governance in an increasingly changing world of modern healthcare could be undertaken in a successful manner by embracing the power of Co-Creation. The concept of good worklife ergonomics is studied, both as a prerequisite, the 'What', and as a success factor in this context, the 'Why'. This article proposes that the moderating, risk mitigating, factor of broadly-based employee involvement in all phases from planning and design to implementation will greatly improve quality in both innovation-process, and outcomes. A case-study from a public homecare living lab eHealth-project in Norway is visited to highlight some of the challenges ahead. Having established that employee co-creation can contribute to successful digital transformation of healthcare services, the 'How' question is studied. The question of how to enable effective employee co-creation is under-researched. Employee participation in co-creation is stated as an important enabler of digitalization and service improvements. The Nordic Model for employee participation has proven successful for enhancing working life effectiveness and innovation. This article proposes that these principles of employee participation can be further enhanced by using web 2.0 technologies for Enterprise Social Networks. The article concludes with a discussion of consequences of applying such social networks for the digital transformation of healthcare services as well as implications for research and practice.

**Keywords**-Co-creation; servitization; digitalization; healthcare; eHealth; Worklife ergonomics; Digital transformation; Employee; The Nordic Model; Web 2.0; Enterprise Social Networks; Enterprise Social Media.

## I. INTRODUCTION

The purpose of this article is to develop a conceptual process-model for co-creation in eHealth innovation, that also supports a good worklife ergonomics for employees. The article builds further on an eTELEMED conference contribution [1] and is a result of a cross-disciplinary collaboration, between one Doctor of Medicine, specializing in health and work environment, and two Doctors of Philosophy in social science, with management information systems as speciality.

In many industrial countries, people live longer, but habitually with chronic diseases, due to better living standards

and medical treatment advances. These changing population demographics mean there is an increasing demand for healthcare services [2]. eHealth technologies accompanied by changes in healthcare delivery processes and services, offer possibilities for a lower cost healthcare system, needed to meet future increases in demand for services. These changes can be referred to as servitization transformation [3] and put an emphasis on the interaction with customers that requires providers to offer customized and total solutions [3]. Digitalization capabilities support such servitization through employees' involvement and codetermination of what should count as key performance indicators. Digitalization is "the use of digital technologies to change a business model and provide new revenue and value-producing opportunities; it is the process of moving to a digital business" [4].

But such change-projects often meet unforeseen barriers. Objections may be raised by the various professional groups themselves. Poor rooted changes risks leading to inferior solutions over time, which may work against their purpose. In Norway, primary care and homecare is a concern for the public sector, municipalities. Generally, new technologies and working methods, as well as new service providers, will have to absorb all the "tacit knowledge" inherent in the public organization to add new values to the services in an efficient manner. If employees are involved, they may be more inclined to become a driving force in the pursuit of a servitization strategy, that relies on developing digitalization capabilities, because the process of defining performance criteria promotes organizational learning [5].

In Norway, primary healthcare and homecare is the concern of the municipalities. Local government-initiated eHealth pilot-projects are often unconnected experiments. A shared and common process management methodology for both development and implementation phases, that incorporates employee involvement and collaboration, will arguably be a useful tool for public sector change leaders who want to introduce new technologies and working methods, or invite new service providers that relieve or complete the overall welfare offer to citizens. We will term this as Co-creation governance ['Co-creation' as a term is disseminated further in Section IV]. Such a tool will be useful in the complex task of maintaining quality for both service recipients and service providing personnel – employees in the healthcare

system. Lenka et al. [3] have recently proposed a model for co-creation between a product or service vendor and end-consumers. But in eHealth innovation in the Norwegian context, system vendors, and health care providers are most often separate entities, so the health care provider generally add value through the combination of human services and the application of technology, not technology alone. Seen from the view of the health care provider, the research and development challenge can be put as:

- How employees' involvement is ensured in eHealth co-creation governance?
- How this involvement contributes to ensuring performance quality on all levels of responsibility?

A potential solution to this challenge is the development of a shared digital capability to continually improve service quality. When in place, this capability will ensure that internal and external service producers act through a continuous quality improvement cycle from plan, check, act, and correct that improves service quality over time. This understanding of digital capabilities is in line with Lenka et al.'s model. But this article argues that this capability must be developed along two dimensions of co-creation or collaborative innovation:

- Horizontally along the chain of value co-creation, from ICT-vendor, through service-provider to home care service users, but also
- Vertically along a line of innovation-process governance, from front-stage service-personnel employees to top-management.

These capabilities must subsequently be built "bottom up" with the involvement and participation of all relevant municipal employees, ensuring that new and increasingly more technology enabled work processes still remain employee friendly, and thus improve the quality of worklife of employees as well as patients' quality of life [6]. This article will also show how Lenka et al.'s aspects of digitalization, servitization and co-creation are linked to our highlighted aspects of [worklife] ergonomics, Business Performance Management, and [Information System] governance.

Ergonomics is an applied science concerned with designing and arranging things people use so that the people and things interact most efficiently [7]. Ergonomics is the science of designing the workplace, keeping in mind the capabilities and limitations of the worker and in such way, fulfil the goals of occupational health and safety, and productivity of employees [8]. The implementation of new digital services in healthcare involves several new work tasks, and thus represents new work processes and potential risk factors at the workplace. Knowledge of this should be addressed to prevent potential negative health effects among employees. This article proposes the term worklife ergonomics as a holistic term that encompasses the system of

service production that spans over workplaces and involved employees. As such, worklife ergonomics as a concept considers the whole information system with people, processes and technology. Employee engagement and involvement brings a new and needed perspective into co-creation servitization, and digitalization.

Effective Business Performance Management, and [Information System] governance are important factors in achieving successful innovation, and the authors will show that such management tools need to be activated in parallel with the system- and service development processes. Employee involvement in the creation and execution of such management tools will serve to ensure the goals are met, and risks for failure are mitigated.

The co-creation literature [3, 9] has shown how the involvement of customers and partners in all stages of innovation and process transformation can add value to new products and services. But there is a gap in this literature regarding the role of employees in innovation and process transformation in large service-organizations like healthcare-organizations. This article will also show the 'How'; how the process of digital transformation in healthcare services can benefit from employee co-creation, and how this can be achieved, using web 2.0 technologies. The propositions put forward here may contribute to both the digital co-creation model, and to healthcare innovation management practice.

Despite the recognition of the need for co-creation, there is a general lack of research that can guide the utilization of the concept in healthcare. The gap is characterized by scarce knowledge about the factors that enable co-creation [9, 10]. Few studies describe the role of employees in co-creation [11]. This gap is of particularly importance in the research on digital transformation of healthcare, due to the important source of knowledge that employees represent. Employees have first-hand knowledge of service demands, they know the process of service production from provider to client, and they have in-depth knowledge of the organization where new technologies and redesigned service production processes will be implemented. What is more, employees know their colleagues and can influence their behavior and acceptance of technology [12] and related changes in work processes [13]. By including and stimulating employees in the process of co-creation, the organization can stimulate and utilize a new driving force in innovations both horizontally and vertically. Horizontally, this knowledge is utilized in the development of service innovations where employees know the service production processes from providers to customers and clients. Vertically, employees' knowledge and influence are utilized when innovations are implemented in the organization as both a technical- and a social system. This vertical dimension, the co-creation between top management and all employees in the healthcare provider organization, thus adds a new source of value creation to the co-creation model.

In healthcare organizations, nurses and other employees who are in direct touch with the patients, e.g., in homecare, accumulate detailed knowledge and experience about clinical practices. This detailed knowledge and experience is arguably of critical significance as input to the process of digitally

transforming the same practices or creating totally new clinical practices. Likewise, employees can be instrumental in the redesign and implementation of new services. Employees can point out critical errors in the service design, seen from a caregiver to patient-relation point of view, that can overthrow otherwise beneficial changes.

Hence, the overall aim of this paper is to close this gap in the literature by exploring how employees can be involved in co-creating new healthcare services. Specific objectives are to extend co-creation literature to healthcare; defining employees' role in digital transformation and co-creation in healthcare, and to show how web 2.0 technologies can enable such employee co-creation in practice.

### *Background*

The so-called Nordic model describes a working life arrangement that not only allows, but in fact requires by law, that employers and employees are cooperating on a regular basis. The authors agree with Ramaswamy and Gouillart [14] in that by giving all stakeholders more attention and influence in the development of a "co-creative enterprise", it is likely insight, revenue and profit will increase. However, how this can be done in an appropriate and feasible manner is not explained in the literature. To describe the organizational significance of employee involvement in co-creation, we will refer to Scandinavian literature from different areas including system development, leadership and innovation, especially the article "Capabilities for Innovation: The Nordic Model and Employee Participation" by Nielsen et al. [15]. The Nordic Model consists of: "First, a comprehensive collective agreements system with coordinated bargaining between the partners at multiple levels; next, employee representation, participation, and cooperation on decisions at various levels; and third, a surveillance system for improving the work environment [15]".

This opens for high employee involvement and describes a potential mechanism for enabling co-creation in the context of service innovations. In this model, employees are important for innovations, based on their education, experience and contacts upstream and downstream of the value chain. They also know their own organization with its culture, leadership, processes and technology. This model applied to the context of service innovation in healthcare will point at mechanisms that enable employees to contribute both to proposals for new service requirements. Employees can also give input on how these innovations can best be implemented in their own enterprise. Innovative projects will have arguably had extra strength when employee's knowledge of service innovation [horizontally] is combined with their experience with service implementation [vertically], and when the goal and rationale of the project is effectively communicated by management.

Although healthcare consists of highly specialized and complex work tasks and patient pathways, and is highly labour intensive, little have been done to research co-creation in healthcare in combination with employee involvement. In countries like Norway, primary healthcare and homecare is the responsibility of local government on a municipal level.

Employees are often involved in testing new types of welfare technology. But systematic employee involvement in problem analysis and -definition and deciding criteria for accepting or rejecting new technology pushes, seems absent in the eHealth [healthcare technology] literature. Perhaps are management hampered by the practical difficulties of involving all interested parties in large distributed service organizations?

To the rescue comes web 2.0, the use of social media within enterprises, also called Enterprise Social Media [ESM]. ESM can facilitate an Enterprise Social Network [ESN], ESN being perhaps the most widely used term in information systems research, in this area [16]. This article thus seeks to inform leaders and practitioners, as well as research, on the rationale for how enterprises can leapfrog into involving and engaging employees on an enterprise-wide platform, using emergent ESM platforms like Workplace [by Facebook], Yammer, and likewise technologies. These technologies offer new opportunities, but also new challenges for eliciting employees' proposals for new service requirements within eHealth, and inputs as to how these innovations can best be implemented in their own enterprise.

The problem formulation thus becomes:

1. How can the co-creation literature be extended to include employee involvement, in the context of healthcare?
2. How can web 2.0 technologies enable such employee co-creation in practice?

Oldham and Da Silva [17] argue that three conditions are necessary if employees are to generate creative ideas:

- Access and exposure to new and diverse information
- Full engagement in the work role
- The experience of socioemotional or instrumental support.

Oldham and Da Silva [17] briefly mention social networking platforms, alongside other types of information and communication systems; electronic communication tools [e.g., email, instant messaging, voice mail, faxing, and paging], electronic conferencing tools [e.g., data conferencing, voice conferencing, videoconferencing, discussion forums, and chat systems], and collaborative work management tools [e.g., file sharing, group calendars, events and polls].

### *The structure of this article*

Having set the background for worklife ergonomics in eHealth co-creation, the rest of this article is organized as follows. In the next section, Methods, criteria for two different literature reviews and a Living Lab case-study are disseminated. In the Section III we disseminate the 'What' of co-creation and the role of employees, and also the rationale for such involvement, the 'Why'. We also present the 'How' [Section III.C] both based on empirical study of a small-scale



Living Lab-concept, and the scaled-up version [Section III.D]. Based on these finds, we propose a model and framework for employee co-creation in Section IV Propositions. Here is also provided a framework for structuring and digitizing an Enterprise Social Network for eHealth co-creation. In Conclusion, the authors show how these articles can contribute to closing the gap in literature on employees' role in eHealth co-creation.

## II. METHOD

The methods applied consists of two different literature reviews and a case-study in a Living Lab project. To devise a conceptual model of worklife ergonomics, we first conducted a literature review to explore how ergonomics are used in relation to the concepts of eHealth, digitalization and co-creation. The authors were looking for state-of art principles in the literature that could guide us conceptually in designing a system that would encompass good worklife ergonomics in eHealth co-creation. A lot of research projects have gone into the different elements needed to enable employees' role in co-creation processes. What this articles authors have set out to do is to contribute to a more holistic approach, binding the different elements together to a coherent roadmap and relating it to the special context of eHealth; see Section III, results.

### A. Literature reviews

A first literature review to map the 'What' question, was thus performed in October 2017. Using Google scholar, the literature was searched for articles containing the criteria [search string]; ergonomics AND digitalization AND servitization AND health AND employees. By using such Boolean-logic operators; 'AND', the authors ensured that the findings where narrowed to only articles including all the key-terms, thus covering the desired context. This search and screening, resulted in three articles that provided concepts with substantially new insight [the rest of the articles screened, only briefly touched the key criteria].

Next, to look closer at the 'Why' and 'How' – questions, this article bases its proposition on the guiding principles of the Nordic Model [15], and web 2.0 technologies, enterprise social media, used in innovation management in organizations [16].

To shed light on how Web 2.0 platforms can involve and positively engage employees in eHealth digital transformation processes, the authors performed a second literature review on the University of Agder's electronic library, February 2018. This library is connected to, and includes, the major search engines like Ebscohost, Scopus and Elsevier. The search criteria's chosen where simply "Workplace", "Facebook" and "Yammer", as these names are some of the most known social media-platforms for use within enterprises. The search was modified to peer-reviewed articles. The search gave 69 hits: screening these, the authors found 24 articles that could shed light on the research problem. In the screening we included articles from other sectors than healthcare, as we perceived that other industries use of enterprise web 2.0 may also inform

the eHealth area of concern. The articles that were excluded from the research, revolved around the use of social media platforms within the educational sector, something we perceived to be a special case, outside our scope. Most of the found, and deemed relevant articles are relatively recent, i.e., from the last three years, showing that this is an area of growing interest to social science and information systems researchers.

### B. Case study in a eHealth Living Lab

The identified concepts from the first literature [see Sections III.A and III.B], were compared with findings from discussions from awareness-workshops in an eHealth Living Lab action research project in a municipality in Norway [see Section III.C] [18]. In this project, the research team [including the authors of this article] held six awareness workshops together with representatives from the municipality [a joint project manager, ICT manager, management and employee representatives from municipal homecare and nursing services]. The workshops focused on these topics:

- Stakeholder analysis
- Service design and 'design thinking' methods
- ICT-business as innovation partners [ref. co-creation with ICT-system vendors]
- Capabilities and organizational learning
- Enterprise performance management, and
- Scaling up innovations from a Living lab.

Two of the authors also visited design workshops where front-line personnel employees in home nursing, together with municipal healthcare-department managers and eHealth researchers, discussed issues and requirements related to a specific service innovation, the use of digital night surveillance for patients in need of this, staying at home, with use of cameras with video conferencing functionalities. This particular part-project is still ongoing research, but now, it is part of an EU-research project [as there are unsolved issues concerning, e.g., privacy]. The Living Lab project went on to study and implement other eHealth applications; home visits by video, and Global Positioning systems for tracking dementia-patients. Issues where detected and solved by using potential users as testers in a user panel, roleplaying care-giver and care receiver in a test lab and living lab setting.

## III. RESULTS

The results are presented in relation to the key terms of the literature search. The identified articles offered design principles that can govern good worklife ergonomics in eHealth co-creation processes.

### A. 'What' - Ergonomics in co-creation – the role of employees

Neubauer and Stary [19] describe ergonomics as acknowledging the role of employees in innovation as leading

to both improvements and financial benefits, through human-centred design.

Human-centred design for interactive systems promotes the following key principles [19]:

- The design is based upon an explicit understanding of users, tasks and environments
- Users are involved throughout design and development
- The design is driven and refined by user-centred evaluation
- The process is iterative
- The design addresses the whole user experience
- The design team includes multidisciplinary skills and perspectives.

Of advocating policies that could improve on this, Lopez-Gomez et al. [20] suggest:

- Promoting the access to highly qualified personnel to develop new concepts and service innovations in-house
- Developing training methods for personnel to be able to adapt innovations acquired from external sources
- Need to better adapt curricula in education and training schemes to the demands of service economy
- Recognizing informal learning so as to increase the attractiveness of continuous training for employees
- Promoting modern innovation management approaches that better support creativity and autonomy of service workers [20]

#### B. 'Why' - Operationalizing these principles in eHealth

While the forgone citations are from industrial contexts, Beaumont et al. [2] focus on service-design in eHealth, and propose that socio-technical, human-centred design approaches are better alternatives to techno-centric design. The article promotes joint innovation tools like service blueprints [21, 22] and stakeholder analysis [6] in the form of Systems Scenario Tool [SST] [23] as a basis. SST combines stakeholder, and system gap-analysis.

The key points in the article are [2]:

- Telehealth equipment and services offer opportunities for bridging the future gap between available health resources and demand created by an increase in life expectancy.
- Current use of telehealth is limited by inadequate business models and service designs that fail to generate successful partnerships and value for customers and suppliers.
- Traditionally, healthcare providers have taken a techno-centric approach to the implementation of new technologies, which often results in unforeseen barriers to success.

- Design and implementation of new services can benefit from a socio-technical approach, which gives equal consideration to both social and technical aspects of a complex system.
- Co-creation of value requires new tools, such as the System Scenarios Tool, which provides stakeholders with a holistic framework to help model the implications of service offering and business model choices.

#### C. 'How' [1] - Design principles applied on a Living Lab project

Comparing these organizational design principles with experiences from the Living Lab project workshops, methods such as stakeholder analysis [6], and service blueprints [op. cit.], as devised in Beaumont et al., found in the literature review [2], proved to be useful in designing new services. To the known service blueprint template for process notation [swim lane diagram] we found it useful to add a band for step purpose and key performance indicators, see Figure 1. In addition to showing the process following a timeline or sequence [steps], the process diagram shows activities at different levels of the information system. The levels include both those parts that are visible to the end-user and the processes back stage, below the "line of visibility" [22]. Adding the purpose of each step purpose makes it possible to extract user stories to form a system requirement documentation for hand-over to Information Technology Infrastructure Library methods [ITIL] [24-26] or agile system development [27], and refined further to precise technical architectures and instructions to ICT-system engineers. At the same time, adding key performance indicators can be a starting point for defining inputs to a joint enterprise process and performance management system. By adding the iteration of a workshop with all involved front-stage and back-stage personnel-employees, like in the Living lab-case [see Section II], more aspects of a proposed innovation can be explored, before expensive investments and changes are made.

Although our process modelling exercise showed the proposed camera-surveillance case to be technically feasible and may give potential benefits to homecare patients, it also showed that such an innovation also has major implications for the worklife for, e.g., home nurses, as well as legal and privacy-issues in general, that needs to be examined and discussed further. The status, as this article is being written, is that implementing the camera-surveillance case has been postponed awaiting more ground research into the needed technology security and quality aspects, while other innovation-paths are now explored in test labs and living labs; e.g., replacing physical home-visits to patients with video-meetings.





Service Blueprint diagram	Pre service	During service		Post service
Step name/no.				
Step purpose				
Key performance indicators				
Service evidence				
User action				
Front stage personnel action	↓ "Visibilityline"			
Back stage personnel action				
Infrastructures (legal, standards, technical)				
<b>Legend</b>				
	Event	Process	Decision	Connection

Figure 1. Service Blueprint diagram template, with "lanes" for purpose and performance indicators added

Here, in the case of video-meetings, service blueprints and other service design-methods have been successfully applied, and pilots for new services may go live soon [in Fall, 2018]. Testing the user's journey through new services, using low or high-fidelity testing [roleplay] gives informed users a pre-experience of the benefits from new improved services. Experience from the Living Lab show that participants in such lab test can contribute with both real-life problem narratives as input to design of new eHealth measures, and later as "ambassadors". Test panel participants can thus positively influence patient groups and colleagues, and help ease eHealth technology adoption, validating the general finds of Taylor and Todd [12], and Eikebrokk et al. [13] in this context.

#### D. 'How' [II] - Scaling up participation using web 2.0 technologies

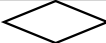
We used Webster and Watson's [28] method for conceptualizing and grouping the finds of the second literature review. The results of this literature review are presented here. The literature review gave us insights within the following concepts and conditional factors:

1. Customer satisfaction
2. ESN adoption
3. Gamification
4. Human resource development
5. Innovation ecosystems and urban planning
6. IT governance
7. Knowledge sharing
8. Management
9. Online design processes
10. Organizational learning
11. Risk factors
12. Avenues for future research

Below are these finds with references to the [group of] reviewed articles that offered new insights into these concepts.

##### 1. Customer satisfaction:

Pintos study [29] shows that customers' [patients'] positive attitude toward social media can be an effective method to enhance PCM [patient-centred medicine] and, ultimately, satisfaction.

##### 2. ESN adoption:

Chin et al. [30] illustrate that the likelihood of ESN use is significantly influenced by technological, organizational, social and individual factors. Sharma and Bhatnagar [31] state that it takes a lot more than mere investing in social media work tools; organizations need to build a "culture of openness and transparency", where employees not only "feel free" to share ideas and opinions but also "feel happy and involved" with high-touch points in their entire employment experience. Doing this, ESN can be utilized to build social capital [trust] within a company [32]. In Razmerita et al.'s study [33] drivers for user adaptation are identified as:

- Environment of helping others
- Monetary rewards
- Management support
- Management encourages and motivates knowledge sharing behaviour, and
- Knowledge sharing is recognized
- Barriers to adaptation of ESN-ESM are:
- [The perceived risks of] Change of behaviour [from hoarding information to sharing information]
- Lack of trust
- Lack of time

### 3. *Gamification:*

The Li et al. article [34] identifies gamification as an important driver for making ESN [and ESM] work. They exhibit four case-studies; Google, Apple, Procter and Gamble, and Ace Hardware. Ace hardware uses the network to solve problems, and exchange ideas and experiences. Google allows employees to spend 20% of their time on their own-defined projects. These ideas are voted for on an “ideation white board”. On the Google Intranet; “MOMA” all information is compiled in to a searchable database, available to all employees. Procter and Gamble includes the employees of partners in their extended ESN, for ideas to new product-lines. Apple have gone further and have built a whole ecosystem for revenue generating services [34].

Gilbert et al. [35] advocate establishing an idea-capture mechanism, using rewards and “Design Thinking” [36] competitions. Although monetary mechanisms and career advancement are important, the “power of fame and franchising should not be underestimated”. Gamification can also be used to enhance learning from enterprise training [37].

### 4. *Human resource development:*

Allowing employees to “brand themselves” will create enterprise winners in the emerging economic environment for the information age, using social learning or e-learning tools [38].

### 5. *Innovation ecosystems and urban planning:*

The innovation eco-system thinking can be extended to whole cities with their residents and businesses. This could be of interest also within an eHealth innovation context, as local governments, in charge of primary healthcare, as in Norway, also have the double goal of stimulating business development, alongside solving healthcare needs. San Francisco city founded the ‘tech chamber of commerce’ [sfcity.org](http://sfcity.org). “An important stated goal of [[sfcity.org](http://sfcity.org)] was to encourage member firms to make pro-bono interventions in the city’s urban infrastructures. The first public statement consisted of a short video circulated via social media [39]”.

### 6. *IT governance:*

Alimam et al. [40] highlight the need to integrate ESM with the enterprise’s existing mechanisms for IT governance and architecture. As the enterprise wants to promote desirable behaviours like collaboration and innovation, integration of these behaviours into an enterprise wide framework seems necessary.

### 7. *Knowledge sharing:*

Knowledge sharing is an important asset to an organization. Especially in distributed organizations, e.g., multinationals, the expatriates rely on ESM for teamwork [41]. Social mechanism of a lighter nature, sharing humour and other kinds of relief, may encourage use of ESM [42], and thus also for more directly productive work.

Many organizations have social responsibility goals and strive to be able to hire and include employee-groups with special needs [43].

### 8. *Management*

ESM needs to be managed, but there are no clear rules as to the level of management needed, it depends on the circumstances, according to Guinan et al. [44]. The article advises three approaches; top-down, from middle management [middle out], and bottom up, depending on the context. In a context with many silos [relevant to, e.g., a healthcare setting and its many stakeholder-groups], middle out may perhaps prevail as the best approach.

Niell and Moody [45] identified nine strategic roles and the associated responsibilities [involved in social media management] including policy maker, internal collaborator, technology tester, communications organizer, issues manager, relationship analyser, master of metrics, policing, and employee recruiter.

e-Leadership may be a lot different from ordinary hierarchical management. Avolio et al. [46] produce a model that shows that the transition management will go through as enterprises become increasingly digital. In general, technologies tend to “flatten out” leadership, and decision-making. There will be a need for leadership development. ESN can be used to enhance such development [47]. Other studies; Korzynski [48] show “that online social networks are more useful for participative and consultative leadership style on social networking platforms than for directive leadership style [op. cit.]”. According to Korzynski [48] the more employees are empowered; the more benefits can be realized from ESN-ESM.

### 9. *Online design processes:*

One article presents a solution for implementing social media functions into a software development project. Alvertis et al. [49] report from an EU-funded project, resulting in the site named CloudTeams [50]. The solution also entails connectors to third party services, and reward end-users for their participation in “campaigns”.

### 10. *Organizational learning:*

The organizational learning aspect of ESN-ESM is disseminated in several articles found in the review. Increased emphasis on ESM may represent a new stress-factor for many employees. So, the organizations should facilitate programs to improve employee’s digital literacy [51]. Increased intensity of collaboration in many environments, like press-work, creates the need for more fine-grained tracing of everyday activities [52]. Using quantitative survey-evaluation methods, Qi and Chau [53] have tested the positive consequences of ESN-site [ESNS] usage, and confirm that “ESNS usage is an important antecedent of knowledge creation and knowledge sharing. ESNS usage is also an important contributor to organizational learning. Knowledge creation and knowledge

sharing both mediate the path between ESNS usage and organizational learning [op. cit.]”.

#### 11. Risk factors:

ESN-tool use is not without its risks, both reducing potential, and for direct economic loss. Comparing with the Excellence theory [54], Verheyden and Cardon [55] finds that management ideology may hamper the information producing abilities of employees and also the realization of benefits from using social media. Employees’ use of ESM could potentially compromise business secrets: Väyrynen et al.’s [56] conceptual article proposes eight questions to ask regarding what roles and authorities’ different categories of employees have. Based on this, strategies to meet knowledge protection challenges can be devised.

#### 12. Avenues for future research

ESN is a topic in need of more research, according to Ellison et al. [57]: “As ESNSs are introduced into a wider range of organizations, it will become increasingly important to study, theorize, and design for the ways in which use of such tools is transforming knowledge sharing and other organizational practices [op. cit.]”.

### IV. PROPOSITIONS

Going from elicited principles [from literature] to propositions, the authors here conceptualize propositions by analysing the principles using the framework of Design Thinking methodologies as lens, as advocated by, e.g., Gilbert et al. [35]. Based on the authors analysis of finds the literature reviews and the case study, propositions are here made for:

- a) Governance principles for co-creative processes involving employees
- b) Realising scaled up-participation using web 2.0 technologies

#### A. Governance principles for co-creative processes involving employees

This article proposes that enterprises that want to succeed with eHealth innovation and co-creation over time, need to secure the involvement of their frontline personnel, because they are key to establishing a Business Performance Measurement system. There are numerous definitions of what a Business Performance Measurement system contains. In a literature review, Franco-Santos et al. [58] identified these main features:

1. Performance measures
2. Objectives/goals
3. Supporting infrastructures [including data acquisition and analysis]

4. Targets [gauges – does the enterprise meet its targets]
5. Causal models [what are drivers for successful performance]
6. Hierarchy/cascade [organization, delegation of concern]
7. Performance contract [negotiated contractual relationships with stakeholders]
8. Rewards [incentives]

Co-creation is a relatively new term. It has become part of the slogan and strategy of many universities. But what does it mean in practice and where does the term come from? A recent review by Galvagno and Dalli [11] traces the term back to three theoretical perspectives including service science, innovation and technology management, and marketing and consumer research. The literature on co-creation operates on two levels of analyses: company centred vs. customer experience centred. Apparent themes in the literature include co-creating value through customer experience and competence, service innovation, including digital customer involvement. Today, service science and marketing play a major role in the literature and refer to the involvement of customers in the supplier's product- and service development. In information systems research and management research, the term co-creation has been used by, among others, Grönroos and Voima [9], and Lenka et al. [3].

Lenka et al. have provided a model that will explain the connection between "megatrends" in industry and working life; digital development and change ["digitalization"] and development of a service culture in production-oriented environments ["servitization"] through co-creation processes. As authors, we agree with Lenka et al., that an important prerequisite for success is the development of digitalization capabilities in service-based organizations. These digitalization capabilities in turn, will govern the "Value Co-creation" mechanisms; consisting of two main mechanisms; one linked to needs analysis [perceptive mechanisms] and one linked to design and construction cycles [responsive mechanisms]. Between these two [from observation to design and construction], knowledge about measurement points is transferred to goals and values that form the basis for implementation of the service [in design and construction]. Both mechanisms must be repeated for each overlapping link in the value chain.

Moreover, we propose that the change work done in these overlapping links in the value chain can be expressed [including the core, the actual digitalization capability] as Deming Cycles [Plan-Do-Study-Act], see Figure 2.

Iterative development-cycles like this allow the time for involvement of both external and internal stakeholder groups and should include discussing goals and measurements. The saying “You can’t manage what you don’t measure” [1] is attributed to both Edwards Deming and Peter Drucker.

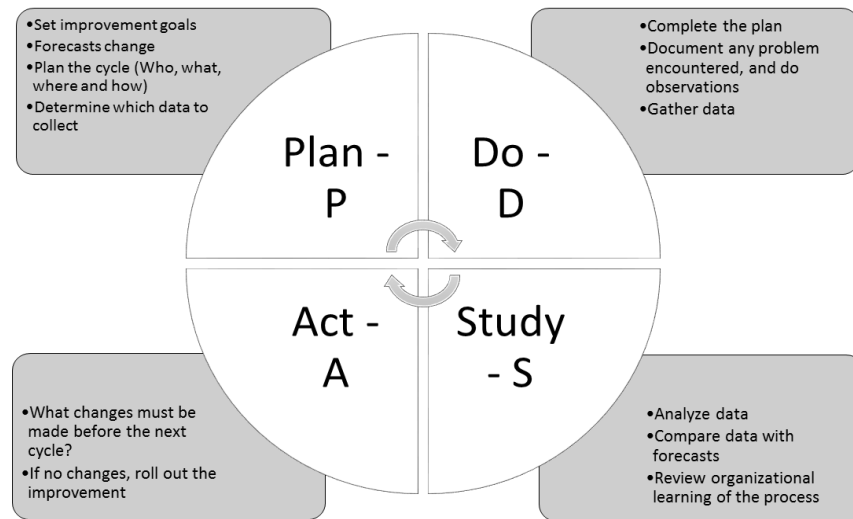

Figure 2. Deming cycles

Focus in achieving worklife ergonomics will be the relationship between the observational input and response outputs from the service co-creation and system co-creation cycles as a prerequisite for successful eHealth co-creation governance. Lenka et al. states, that value is added at each part of the chain, as new actors bring in new experiences, see new opportunities and add new value to the service. This includes the service consumers themselves, and their next-of-kin. The measurement system will be a trigger for new innovations, while being a missed "GPS" guidance system, to find the way [59]. Such a system will also act to spur organizational learning, providing incentives that motivate and intensify innovation [59].

To stay relevant, since the frames, and context, of the eHealth area is rapidly changing, we believe that the overall quality system [Process and performance management system] itself must be agile and subject to at least annual evaluation [a slower Deming cycle], while the services that the system controls, go through its many and fast Deming cycles. Together, these form a proposed conceptual process-model for co-creation in eHealth innovation, that also supports good worklife ergonomics. The concept is illustrated in Figure 3. The thickening of the arrows in the value-delivery chain in bottom of the figure illustrates how value is added with each chain in the delivery from new technology to improved services, in accordance with Lenka et al.'s model.

The users both add value and gain value. Finds from the case study [Section II.B] indicate that new eHealth technologies successfully implemented can improve quality of worklife, the feeling of self-efficacy; mastering work task in a better way with less unnecessary waste of time and

acquiring new skills. Healthcare users can also add value to the service, in even unforeseen ways, using new technology to solve more problems at a time. When it comes to the Plan-Do-Study-Act cycles in the value-chain [system co-creation, service co-creation] – different process modelling tools, like swim lane diagrams, can be used to visualize, convey, and discuss the consumer journey with stakeholders, using, e.g., "Service Blueprint" or similar [21, 60].

All in all, the goal is that the entire ecosystem is set in a state of continuous improvement and value innovation, and that a shared and improved service culture in the municipalities and their partners, [servitization], develops through digital transformation. This secures the ability to go back and start again, if necessary.

### B. Realising and scaled up-participation using web 2.0 technologies

Based on the finds from the second literature review and analysing this through the lens of the general literature on co-worker co-creation, we can list several healthcare innovation capabilities provided by a broad participation in digital transformation and eHealth innovation processes, open to all involved employees in healthcare [illustrated in Figure 4.]. This figure also illustrates the main benefits:

- Increased knowledge base
- Enhanced digital worklife ergonomics [digital systems that are better adapted to real life work-processes]
  - Increased involvement and implementation
  - Support from employees in designing and implementing change



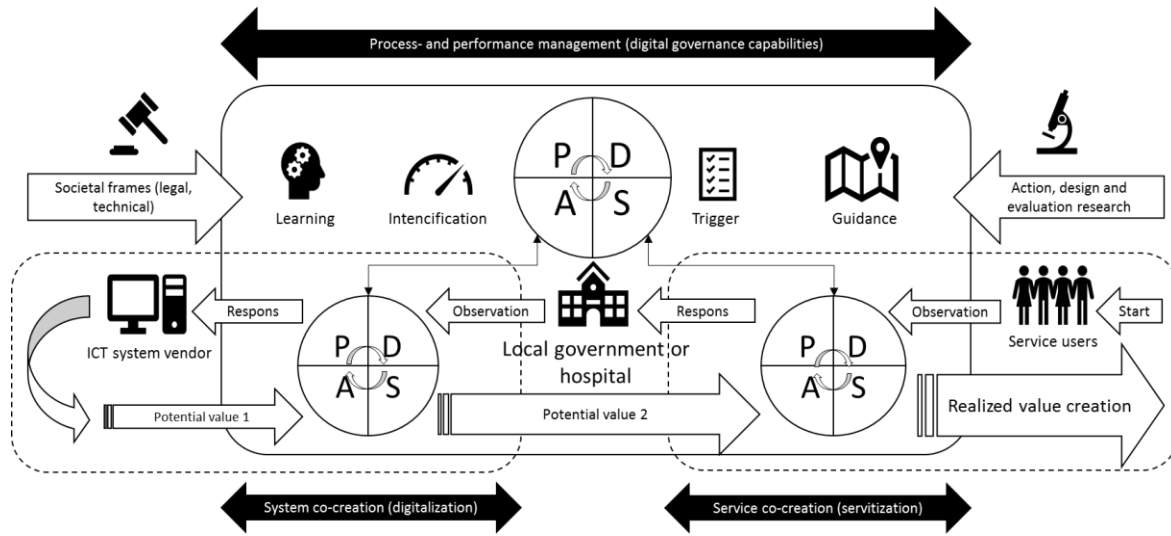

Figure 3. Process-model for co-creation in e-Health innovation; The ecosystem [Based on Lenka et al., 2017].

Based on the review on web 2.0 concepts we will here present some propositions for how employee involvement can be secured, to achieve these desired benefits and capabilities. We propose that the effect of employing ESM can be enhanced by adding a plan and structure to the co-creation process. When looking for a framework that can provide plan and structure, the authors have used the Design Thinking philosophy [60, 61] as a guide. Design thinking is a human- and needs-centric approach to innovation [op. cit.] that is well aligned with the needs of the very labour-intensive healthcare sector. Arguably, Service Design Thinking [60] is the new model for collaborative Business Process Management [62] and addresses and simplifies some complexity issues in business process modelling [6].

The British Design Council’s Double Diamond – model [63] can thus be used as a framework for casting several of the ideas and concepts from the literature review as steps in a design process or roadmap; see Figure 5. The Double

Diamond – model in its many variations has rapidly become a standard for guiding design processes in a user- and problem centric manner, associated with the Design Thinking philosophy [36]. The Diamond shape symbolizes activity levels through a time-line, and due to activities and material collected or produced peaking midway in each Diamond.

The Double Diamond’s two parts revolve around problem and solution respectively, with decision milestones at start, end and in between the two “Diamonds”. The Problem-Diamond is divided in two distinct phases:

- Discover [the features of the problematic area, and its stakeholders], giving insights into the problem
- Define – the area to focus on. Questions to ask are: “Which area matters most? Which area should we act on first? What is feasible?”

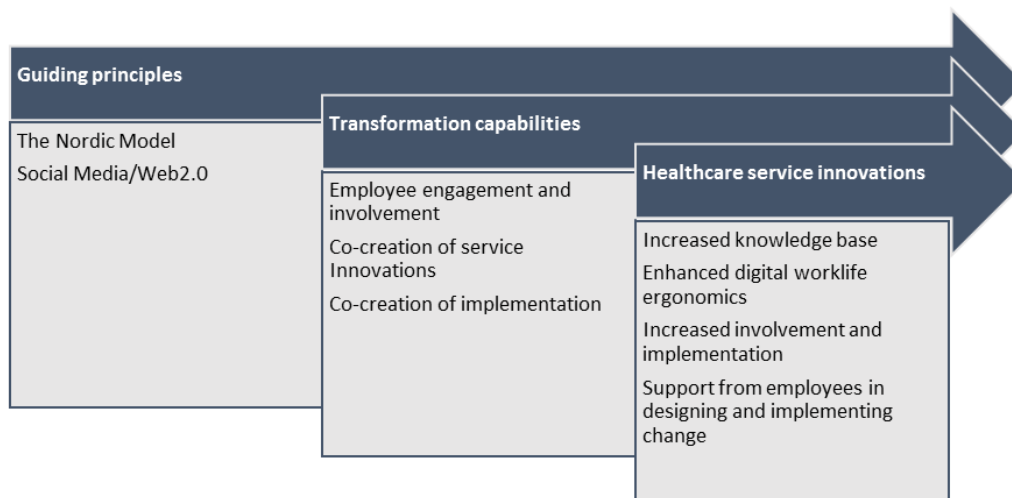

Figure 4. A conceptual model for sequential and overlapping process steps and impacts in co-creating digital transformation in healthcare

Starting joint problem-solving with the problematic situation, can widen the frame for [co-]creation [61]. Arguably this opening of a discourse should encompass all employees to achieve the added value that the enterprise is striving for [op. cit.]. The British Design Council states that; “One of the greatest mistakes is to omit the left-hand diamond and end up solving the wrong problem [63].” This can underpin the concepts of knowledge sharing, organizational learning and the online design process. Having defined the problem, a brief for the design can be formed, thus starting the Solution-Diamond, where the focus is to:

- Develop – potential solutions [in plural; testing different alternatives]. “This process of trial and error helps designers to improve and refine their ideas [op. cit.]”
- Deliver – solutions that work, this tie narrowing the field based on decision criteria from the brief, and evaluations done underway.

This should be comprehended as an iterative process. “This means that ideas are developed, tested and refined a number of times, with weak ideas dropped in the process. This cycle is an essential part of good design [63]”.

We propose that this “wisdom of crowd”, especially using the inherent knowledge and wisdom of employees, can be mobilized throughout the process using ESN – ESM, for:

1. “Service innovation”; choosing the right problem; defining a new service blueprint [22]
2. “Implementation”; including new eHealth measures; choosing the right solution

The process-structure should also include a joint process for digital governance, as the literature review has shown a need for management of ESN/ESM and the whole design process; measuring and ensuring other concepts found in the literature review [like customer satisfaction, human resource development and risk factors], ref. Figure 5:

3. Process management, IT service transition governance [25], consisting of:
  - 3.1. Setting goals [based on problem]
  - 3.2. Decision criteria [quality measures; based on problem definition and design brief, following the “Service innovation”; 1. above]
  - 3.3. Evaluation [evaluating the total solution, following the “Implementation”; 2. above. Also evaluating the whole design process]

Polls on ESM [gamification] can be utilized for advising top managers, as to what measures should be prioritized, and how. If necessary, all steps and phases can be iterated until the aspired level of confidence in the measures and potential values are reached. Leveraging the increased knowledge base, and support of all employees, with defined criteria’s and milestones for decision-making, chances for successful

implementations are optimized, and the potential risk for failed investments may be mitigated.

Adding the support process of process management, allows for having a holistic governance of parallel innovation projects and involving employees in the performance management of the whole segment of healthcare, as well in individual welfare technology projects [64].

## V. CONCLUSION AND FUTURE WORK

This articles literature searches have shown that for the purpose of establishing a holistic eHealth innovation ecosystem-concept, and achieving digitalization and servitization throughout the organization, the following elements are necessary [but perhaps not sufficient]; digital governance capabilities, process and performance management methods and systems that align new technologies with high quality work processes [worklife ergonomics], and appropriate tools to visualize and communicate processes and services with end-users, as well as different professional employee groups involved, front stage and back stage. By involving employees though iterative project-cycles and achieving a general consensus on what goals and measures should count, the necessary sorting and maturing of ideas is achieved, so that failed changes can be avoided before too great investments are made and lost.

Other factors that are necessary are processes that align local service strategies with central government legal and technical frames [compliance]. More research is needed on how these different eco-systems [central, local] can be efficiently combined.

More research is needed into future innovative means of capturing both qualitative and quantitative data about end-users or patients’ using “Big data”; combining social media and transaction data from the service systems. More action, design and evaluation research are also needed for devising how the proposed model [Figure 3] can be implemented and operationalized in a manner that ensures both employee and end-user involvement and commitment for achieving a high quality, lower cost health care system, while maintaining a high quality of worklife.

This article has also shown digital transformation and -innovation in healthcare with employee involvement in the co-creation process, can be further enhanced through the help of web 2.0 technologies. The article contributes to the growing co-creation literature [3, 9], by adding the vertical dimension of internal co-creation between healthcare management and all employees. This contributes to answering our first research problem-area; the ‘What’ and ‘Why’ of how can the co-creation literature be extended to include employee involvement, in the context of healthcare?

Further research could deal with the question of how such use of digital technology in the co-creation process, can enhance and clarify the role of employees.

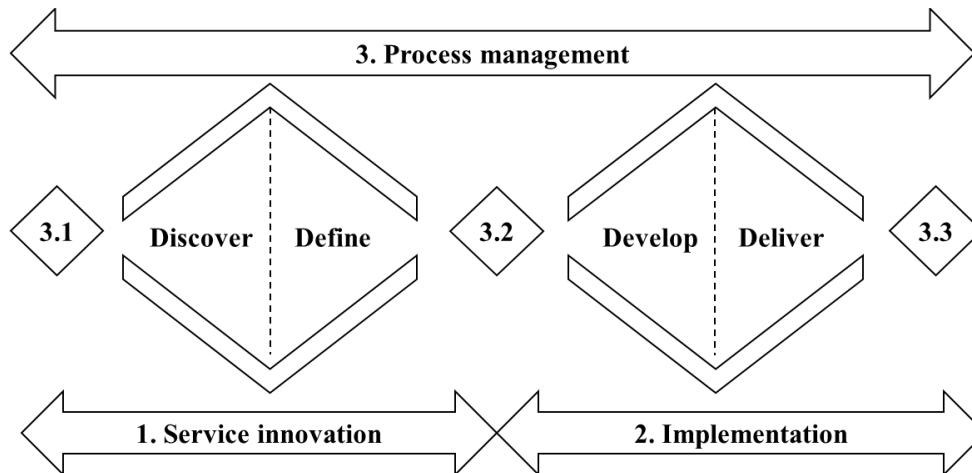

Figure 5. "Double Diamond" framework for Web 2.0-enabled eHealth design process or roadmap

The clarity of roles and tasks for employees in introducing new technology at the workplace is also a necessary workplace environment factor, which prevents adverse health effects among employees; so-called technostress [65].

A model-test of the proposed frameworks could show if successful implementation and outcomes are enabled, and risk-management of adverse health, safety and environment effects when introducing new technologies are improved.

Some healthcare organization have programs for encouraging open innovation [66] or capturing ideas from employees' inventions, and some organizations use software for this, like Spigit [67], Ideation360, Inductsoftware or the research-based CloudTeams [50]. Further case-studies; e.g. action- and design research could show how such software could involve and engage the whole organization in digital transformation and co-creation in combination with web 2.0 technologies. However, caution is needed, as our case-study [ref. Sections II.B and III.C] has indicated, some social engineering may be a necessary step before introducing technology.

One of the findings from this case study, as recognized by the responsible municipality project management, is the great value the users [both internal users, and home care receivers] have in the innovation work. The user panels are not passive testers, they contribute ideas and input. Often the participants in the user panel have taken a role as ambassadors for other employees in the municipalities [those not directly involved in the lab tests] and other potential users. Thus, they have played an active role in the creation of new products and services.

All in all, this Living Lab approaches the principles of co-creation. But getting there was a process long in the making. Finding suitable first uses as well as the persons suited to man up the user panels for pilot studies required a lot of effort by the municipalities project management. There may still be issues concerning to the scaling up of implementations, from small scale pilots, to large scale service production. Applying web 2.0 technologies may be helpful here.

### Limitations

Our conclusion is partly based on search in scholarly literature within fields like information systems and management [with emphasis on the first; information systems research] using specific search criteria. Our search and screening are surely not exhaustive. Other criteria might have given other finds of relevance to this article's scope. Within strategy and management research disciplines there may be relevant sources of studies, e.g., within the Workplace Innovation-literature [68] not reported here. There may also be instances of web 2.0 and ESN practice of interest to this research and reported in scholarly literature that have not been found by this article's authors.

### REFERENCES

- [1] N. F. Garmann-Johnsen, M. Helmersen, and T. R. Eikebrokk. "Worklife Ergonomics in eHealth Co-Creation Governance - You can't manage what you don't measure," The Tenth International Conference on eHealth, Telemedicine, and Social Medicine (eTELEMED 2018), IARIA, Mar. 2018, ISSN: 2308-4359, ISBN: 978-1-61208-618-7
- [2] L. Beaumont, L. Bolton, A. McKay, and H. Hughes. "Rethinking service design: a socio-technical approach to the development of business models," *Product Development in the Socio-sphere*: Springer; 2014. pp. 121-41.
- [3] S. Lenka, V. Parida, and J. Wincent. "Digitalization Capabilities as Enablers of Value Co - Creation in Servitizing Firms," *Psychology & Marketing*. 2017; 34 [1]: pp. 92-100.
- [4] Gartner. *IT glossary* [Online] Available from: <https://www.gartner.com/it-glossary/digitalization/> 2018.12.01
- [5] R. G. F. Braz, L. F. Scavarda and R. A. Martins. "Reviewing and improving performance measurement systems: An action research," *International Journal of Production Economics*. 2011; 133 [2]: pp. 751-60.
- [6] N. F. Garmann-Johnsen, and Ø. Hellang. "Collaborative Process Modelling and Evaluation in E-health," *Scandinavian Conference on Health Informatics*; August 22; 2014; Grimstad;

- Norway; 2014: Linköping University Electronic Press, ISSN (online): 1650-3740, ISBN: 978-91-7519-241-3
- [7] Merriam-Webster. *Dictionary* [Online] Available from: <https://www.merriam-webster.com/dictionary/ergonomics> 2018.12.01.
  - [8] L. Punnett, M. Cherniack, R. Henning, T. Morse, and P. Faghri. "A conceptual framework for integrating workplace health promotion and occupational ergonomics programs," *Public Health Reports*. 2009; 124 [4\_suppl1]: pp. 16-25.
  - [9] C. Grönroos, and P. Voima. "Critical service logic: making sense of value creation and co-creation," *Journal of the academy of marketing science*. 2013; 41 [2]: pp. 133-50.
  - [10] P. Frow, S. Nenonen, A. Payne, and K. Storbacka. "Managing co-creation design: A strategic approach to innovation," *British Journal of Management*. 2015; 26 [3]: pp. 463-83.
  - [11] M. Galvagno, and D. Dalli. "Theory of value co-creation: a systematic literature review," *Managing Service Quality*. 2014; 24 [6]: pp. 643-83.
  - [12] S. Taylor, and P. A. Todd. "Understanding information technology usage: A test of competing models," *Information systems research*. 1995; 6 [2]: pp. 144-76.
  - [13] T. R. Eikebrokk, J. Iden, D. H. Olsen, and A. L. Opdahl. "Determinants to the use of business process modeling," 43rd Hawaii International Conference on System Sciences (HICSS), 2010; IEEE, Electronic ISBN: 978-1-4244-5510-2, Print ISBN: 978-1-4244-5509-6, Print ISSN: 1530-1605
  - [14] V. Ramaswamy, and F. J. Gouillart. *The power of co-creation: Build it with them to boost growth, productivity, and profits*. Simon and Schuster; 2010.
  - [15] P. Nielsen, R. N. Nielsen, S. G. Bamberger, J. Stamhus, K. Fonager, and A. Larsen, et al. "Capabilities for innovation: The Nordic model and employee participation," *Nordic Journal of Working Life Studies*. 2012; 2 [4]: p. 85.
  - [16] B. Wehner, C. Ritter, and S. Leist. "Enterprise social networks: A literature review and research agenda," *Computer Networks*. 2017; 114: pp. 125-42.
  - [17] G. R. Oldham, and N. Da Silva. "The impact of digital technology on the generation and implementation of creative ideas in the workplace," *Computers in Human Behavior*. 2015; 42: pp. 5-11.
  - [18] N. F. Garmann-Johnsen, T. R. Eikebrokk, M. Helmersen, and K. Lindland. *Agder Living Lab - Hvordan lykkes med tjenesteinnovasjon i eHelse* [Online] Available from: [Agderforskning.no](http://agderforskning.no); 2018.12.01.
  - [19] M. Neubauer, and C. Sary. *S-BPM in the Production Industry*. Springer; 2017.
  - [20] C. López-Gómez, D. Leal-Ayala, M. Palladino, and E. O'Sullivan. *Emerging trends in global advanced manufacturing. Policy links*: University of Cambridge; 2013.
  - [21] G. Lynn Shostack. "Designing Services That Deliver," *Harvard Business Review*. 1984.
  - [22] M. J. Bitner, A. L. Ostrom, and F. N. Morgan. "Service blueprinting: a practical technique for service innovation," *California management review*. 2008; 50 [3]: pp. 66-94.
  - [23] H. P. Hughes, C. W. Clegg, L. E. Bolton, and L. C. Machon. "Systems scenarios: a tool for facilitating the socio-technical design of work systems," *Ergonomics*. 2017: pp. 1-17.
  - [24] J. Iden, and T. R. Eikebrokk. "Implementing IT Service Management: A systematic literature review," *International Journal of Information Management*. 2013; 33 [3]: pp. 512-23.
  - [25] T. R. Eikebrokk, and J. Iden. "ITIL implementation: The role of ITIL software and project quality," 23rd International Workshop on Database and Expert Systems Applications [DEXA]; 2012: IEEE, ISBN 978-3-642-32597-7
  - [26] J. Iden, and T. R. Eikebrokk. "Using the ITIL process reference model for realizing IT Governance: An empirical investigation," *Information Systems Management*. 2014; 31[1]: pp. 37-58.
  - [27] R. Hoda, J. Noble, and S. Marshall. "Self-organizing roles on agile software development teams," *IEEE Transactions on Software Engineering*. 2013; 39 [3]: pp. 422-44.
  - [28] J. Webster, and R. T. Watson. "Analyzing the past to prepare for the future: Writing a literature review.," *MIS quarterly*. 2002: pp. xiii-xxiii.
  - [29] M. B. Pinto. "Social media's contribution to customer satisfaction with services," *The Service Industries Journal*. 2015; 35 [11-12]: pp. 573-90.
  - [30] C. P-Y. Chin, N. Evans, and K-K. R. Choo. "Exploring factors influencing the use of enterprise social networks in multinational professional service firms," *Journal of Organizational Computing and Electronic Commerce*. 2015; 25 [3]: pp. 289-315.
  - [31] A. Sharma, and J. Bhatnagar. "Enterprise social media at work: web-based solutions for employee engagement," *Human Resource Management International Digest*. 2016; 24 [7]: pp. 16-19.
  - [32] C. King, and H. Lee. "Enhancing internal communication to build social capital amongst hospitality employees—the role of social media," *International Journal of Contemporary Hospitality Management*. 2016; 28 [12]: pp. 2675-95.
  - [33] L. Razmerita, K. Kirchner, and P. Nielsen. "What factors influence knowledge sharing in organizations? A social dilemma perspective of social media communication," *Journal of Knowledge Management*. 2016; 20 [6]: pp. 1225-46.
  - [34] Q. Li, R. N. Nagel, and L. Sun. "Migrating to Agility 2.0.: How social computing creates strategic value," *Organizational Dynamics*. 2011; 40 [2]: pp. 119-26.
  - [35] D. H. Gilbert, A. C. Smith, F. Sutherland. "Osmotic strategy: Innovating at the core to inspire at the edges. *Organizational Dynamics*," 2015; 44 [3]: pp. 217-25.
  - [36] M. Stickdorn, M. Hormess, A. Lawrence, and J. Schneider. *This Is Service Design Doing - Applying Service Design Thinking in the Real World*. O'Reilly; 2018.
  - [37] M. T. Cardador, G. B. Northcraft, and J. Whicker. *A theory of work gamification: Something old, something new, something borrowed, something cool?* *Human Resource Management Review*. 2017; 27 [2]: pp. 353-65.
  - [38] W. F. Cascio. *Leveraging employer branding, performance management and human resource development to enhance employee retention*. Taylor & Francis; 2014.
  - [39] D. McNeill. "Governing a city of unicorns: technology capital and the urban politics of San Francisco," *Urban Geography*. 2016; 37 [4]: pp. 494-513.
  - [40] M. Alimam, E. Bertin, and N. Crespi. "ITIL perspective on enterprise social media," *International Journal of Information Management*. 2017; 37 [4]: pp. 317-26.
  - [41] M. K. Omar, N. A. Dahalan, and Y. H. M. Yusoff. "Social Media Usage, Perceived Team-Efficacy and Knowledge Sharing Behaviour among Employees of an Oil and Gas Organisation in Malaysia," *Procedia Economics and Finance*. 2016; 37: pp. 309-16.
  - [42] J. L. Gibbs, J. Eisenberg, N. A. Rozaidi, and A. Gryaznova. "The "megapozitiv" role of enterprise social media in enabling cross-boundary communication in a distributed Russian organization," *American Behavioral Scientist*. 2015; 59 [1]: pp. 75-102.
  - [43] N. Vohra, V. Chari, P. Mathur, P. Sudarshan, N. Verma, and N. Mathur, et al. "Inclusive Workplaces: Lessons from Theory and Practice," *Vikalpa*. 2015; 40 [3]: pp. 324-62.
  - [44] P. J. Guinan, S. Parise, and K. Rollag. "Jumpstarting the use of social technologies in your organization," *Business Horizons*. 2014; 57 [3]: pp. 337-47.

- [45] M. S. Neill, and M. Moody. "Who is responsible for what? Examining strategic roles in social media management," *Public Relations Review*. 2015; 41 [1]: pp. 109-18.
- [46] B. J. Avolio, J. J. Sosik, S. S. Kahai, and B. Baker. "E-leadership: Re-examining transformations in leadership source and transmission," *The Leadership Quarterly*. 2014; 25 [1]: pp. 105-31.
- [47] K. L. Cullen-Lester, C. K. Maupin, and D. R. Carter. "Incorporating social networks into leadership development: A conceptual model and evaluation of research and practice," *The Leadership Quarterly*. 2017; 28 [1]: pp. 130-52.
- [48] P. Korzynski. "Online social networks and leadership: Implications of a new online working environment for leadership," *International Journal of Manpower*. 2013; 34 [8]: pp. 975-94.
- [49] I. Alvertis, S. Koussouris, D. Papaspyros, E. Arvanitakis, S. Mouzakitis, and S. Franken, et al. "User Involvement in Software Development Processes," *Procedia Computer Science*. 2016; 97: pp. 73-83.
- [50] W. Prinz. *Cloudteams* [Online] Available from: <https://customers.cloudteams.eu/projects/> 2018.12.01.
- [51] W. van Zoonen, J. W. Verhoeven, and R. Vliegthart. "Understanding the consequences of public social media use for work," *European Management Journal*. 2017; 35 [5]: pp. 595-605.
- [52] S. Pigg. "Coordinating constant invention: Social media's role in distributed work," *Technical Communication Quarterly*. 2014; 23 [2]: pp. 69-87.
- [53] C. Qi, and P. Y. K. Chau. "Will enterprise social networking systems promote knowledge management and organizational learning? An empirical study," *Journal of Organizational Computing and Electronic Commerce*. 2018; 28 [1]: pp. 31-57.
- [54] J. E. Grunig. *Excellence in public relations and communication management*. Routledge: 2013.
- [55] M. Verheyden, P. Cardon. "Social software and internal communicators' gatekeeping sense of self," *Public Relations Review*. 2018.
- [56] K. Väyrynen, R. Hekkala, and T. Liias. "Knowledge protection challenges of social media encountered by organizations," *Journal of Organizational Computing and Electronic Commerce*. 2013; 23 [1-2]: pp. 34-55.
- [57] N. B. Ellison, J. L. Gibbs, and M. S. Weber. "The use of enterprise social network sites for knowledge sharing in distributed organizations: The role of organizational affordances," *American Behavioral Scientist*. 2015; 59 [1]: pp. 103-23.
- [58] M. Franco-Santos, M. Kennerley, P. Micheli, V. Martinez, S. Mason, and B. Marr, et al. "Towards a definition of a business performance measurement system," *International Journal of Operations & Production Management*. 2007; 27 [8]: pp. 784-801.
- [59] A. Pavlov, and M. Bourne. "Explaining the effects of performance measurement on performance: An organizational routines perspective," *International Journal of Operations & Production Management*. 2011; 31 [1]: pp. 101-22.
- [60] J. Schneider, and M. Stickdorn. *This is service design thinking: basics, tools, cases*. Wiley: 2011.
- [61] K. Dorst. "The core of 'design thinking' and its application," *Design studies*. 2011; 32 [6]: pp. 521-32.
- [62] N. F. Garmann-Johnsen, and T. R. Eikebrokk. *Critical Success Factors for Inter-Organizational Process Collaboration in Ehealth*. The Sixth International Conference on eHealth, Telemedicine, and Social Medicine (eTELEMED 2014) IARIA Mar. 2014, ISSN: 2308-4359, ISBN 978-3-642-32597-7
- [63] British Design Council. *The Design Process: What is the Double Diamond?* [Online]. Available from: <https://www.designcouncil.org.uk/news-opinion/design-process-what-double-diamond> 2018.12.01.
- [64] S. S. Nudurupati, S. Tebboune, and J. Hardman. "Contemporary performance measurement and management [PMM] in digital economies," *Production Planning & Control*. 2016 ;27 [3]: pp. 226-35.
- [65] R. Karasek, and T. Theorell. *Healthy Work: Stress, productivity and the the reconstruction of working life*. Basic books: 1990.
- [66] H. W. Chesbrough. *Open innovation: The new imperative for creating and profiting from technology*. Harvard Business Press: 2006.
- [67] Spigit. *Aligning Crowdsourcing with Corporate Strategy at Harvard Pilgrim Health Care 2018* [Online]. Available from: <http://go.spigit.com/ignite-2018-patricia-forts-harvard-pilgrim.html>
- [68] F. Pot, S. Dhondt, and P. Oeij. *Social innovation of work and employment*. In: *Challenge social innovation*. Springer: 2012. pp. 261-74.



# The Phisiomimetics as the Main Principle of architectural Forming and Aesthetic Emotions

Olga Chebereva

Federal State Budgetary Educational Institution of Higher Education "Nizhny Novgorod State University of Architecture and Civil Engineering", Nizhny Novgorod, Russia  
chebereva\_on@nngasu.ru, chebereva@mail.ru, chebereva02@gmail.com

**Abstract**— The value of a new evidence-based design approach to architectural forms is known. The paper then focuses on the essence of the interrelation between psychophysiology and geometric semantics as three-dimensional environment or stable patterns of architectural form as a semiotic structure. The architectural forming creativity is the process of generation of architectural form, the morphogenesis of "structural information". The search for principles, methods, and regularities of the forming process should be carried out from the psychophysiology of perception and cognition of architecture. It's an interdisciplinary study to understand the relations between the design of built-environments and associated human emotions. This interrelation represents the affective and reflex basis of the spatial imagination and the corresponding dominant activity of the neural network. It turns to be the basis of the study of psychophysiology of aesthetic emotions in the perception of form. The main subject of the paper is the discussion of proper theoretical base for revealing actual directions and methods for experimental work providing objective results in neuroscience, design research and developing the evidence-based design. A list of necessary experiments on personal emotional reactions on architecture objects is proposed. The conclusion gives the review of applying empirical scientific research knowledge to a creative design process.

**Keywords**- *Architecture; structural information, cognitive; spatial imagination; mode of imagination, neural network; perception; experimental, aesthetics, evidence-based design; creativity; design research; design means.*

## I. INTRODUCTION

There is an active scientific interest in the effects of architectural forms on the brain. Neuroscience and neuropsychology of perception of the architectural form and artificial spatial environments by humans is an actual scientific problem because of the content of the architectural theory. The study of it has become a special subject of the American Academy of Neuroscience for Architecture. There is a special direction of "healing architecture" in European projects for healthcare and "contemplative architecture" in American cognitive publications. While studying the influence of three-dimensional visual stimuli on the brain, Russian and European scientists may potentially need a multidisciplinary study of the processes related to cognition and perception. So, even experimental database

neuroscience, neuropsychology, biology, and psychophysiology are not enough now, because it does not create a complete map of what is happening in the human mind. Natural Sciences do not give a huge understanding of the processes of perception of the surrounding reality. I.e., in general the study needs to be completed by, anthropology, philosophy, art theory, the theory of architecture, sociology, even archeology and history. Only an analytic comparison of different sciences and disciplines can create a complete picture of perception processes and help to analyze necessary directions and compose the list of experimental work in order to reveal what design strategies are more human oriented.

The paper develops previous analysis of the author [1] and is organized as follows. Section II differentiates streams of aesthetic rating and cognition of recognizable pattern vs. archetype of perception [1]-[6]. Section III presents theoretical basis for the separation neural networks and physiology based modes of spatial imagination according to Duran [7] and gives the key for understanding of those modes [8]-[10]. In Section IV, there is a brief comparison of the neural networks base of Duran's [7] and Ukhtomsky's [11] concepts. Section V gives the review of the most important for the list of necessary contemporary anthropological, theoretical architectural and neuroscience issues for the important experimental work. Section VI gives a list of necessary experiments. The conclusion enlightens unresolved problems of the connection between formal characteristics of an architectural form as a visual stimulus and neural networks and physiology responses. At the end there are future perspectives of developing the phisiomimetics as the method of research based creative design process for architectural forming given.

## II. COGNITION OF REGORGNIZABLE PATTERN AND PERCEPTION OF ARCHETYPE

In order to compare the variety of scientific conceptions [1]-[6], we have to postulate[1] that cognitive and perception processes (see Table I) are the interaction of two informative horizons, i.e., the language of concepts and the visual formal language representing a three-dimensional lattice for composite design sliding. The experimental aesthetics of Fechner (Table I) discerns associative and

direct factors of the aesthetic impact of the form, similar to the concept of Shapoval [4] (see Fig. 1). There is a wide connection between the streams of aesthetic impact and combinatory levels of architectural form. The structure of architectural form is a kind of two-level grammar (see Table I).

TABLE I. COMBINATORIAL LEVELS OF THE ARCHITECTURAL FORM

Researcher	Combinatorial level of architectural forming	
	Signs, symbols, Pattern associations	formal geometric (archetypes), Abstract associations
Fechner [1]	associative factor	formal factor
Jenks [4]	signifier	signifying
Alexander[5]	pattern language	abstract
General	recognizable types of forming	geometry archetypes

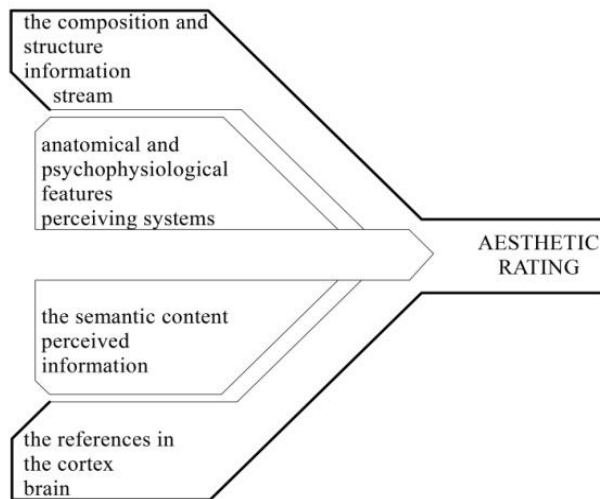

Figure 1. Two streams of aesthetic evaluation.

Primary geometrical elements give abstract associations because of connection with genetic archetypes of artificial perception. The problems of genetic archetypes (primary means of the architectural forming): rhythm, meter, space, metaphor, etc. equally belong to the problem area of the theory of architecture. The rhythm archetype has no clear foundation in the theory of architecture: there is a lack of general theory of composition at the formal and subject levels [1,2]. The fundamental archetypes of architectural forming are determined as geometrical manifestations of anthropological structures of the imagination [6]. This implies the reflexes based on archetypal groups of the spatial-imagination basic patterns [7].

Stable morphological artifacts of the architecture could be called "ARCHItypes" by analogy with recognizable

types in other fields of culture. The neuropsychological studies of the archaeologist and anthropologist David Lewis Williams [8] are interesting in this regard. His experimental work shows that the motor skills of the modern subjects at drawing geometric primitives are completely analogous to the cave ones [8]: metric linear grid, ornamental concentric and rhythmic motives, spiral forms, etc. (see Fig. 2).

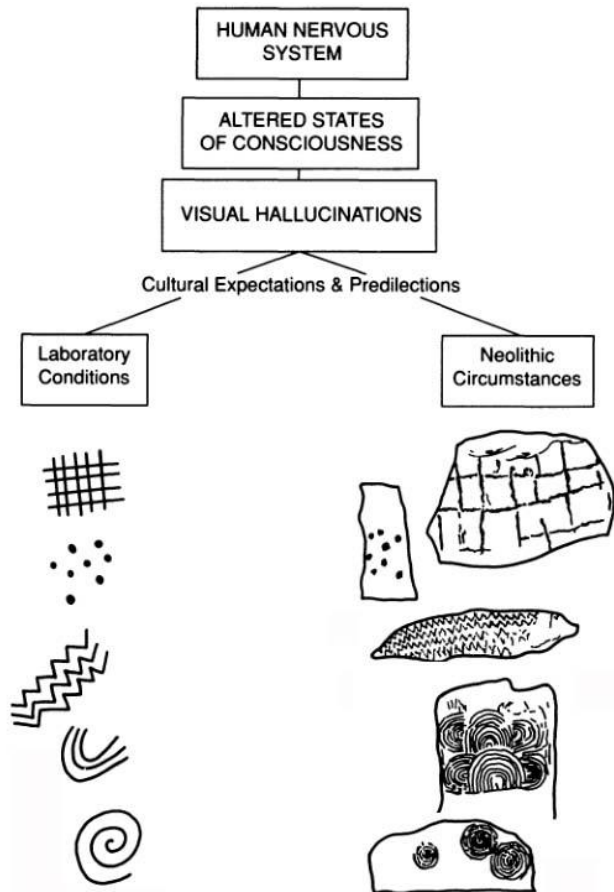

Figure 2. Comparison of the entopic forms depicted under laboratory conditions (after Siegel 1977) and in Neolithic art [8].

All these are currently used by the formal contemporary art and architecture. That is why ARCHItypes should be considered as stable and typologically recognizable elements of architectural forms and composite structures composed of them, bearing certain symbolic meanings and correlated with the epoch and style. Archetypes are geometrized manifestations of the spatial-imagination modes having a reflex nature, as it was shown in Williams' experiments and Picasso drawings (see Fig. 2 and Fig. 3). Figure 3 represents the drawing of Picasso (1924) included in the illustrated edition of "Unknown Masterpiece" [10] written by Honore de Balzac.

Let us recall that the primary art examples are more ancient than languages and architecture for more than 40 800 years BC [9]. From this viewpoint, the imagination



mechanisms for the mass, space, and rhythmic ratio represent the “archetypes” of architectural form [1, 2]. The primary elements of architecture and the rules for their connection are still the main problem in the theory of architectural composition, being not its specific subject.

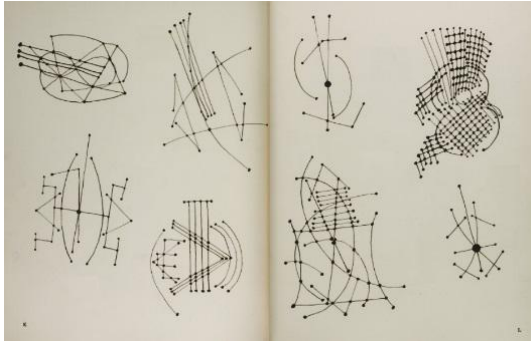

Figure 3. Drawings of Picasso (extracted from [10]).

### III. DURAND'S COGNITION CONCEPT

#### A. Durand's concept about archetypes of spatial imagination

An interesting research of the archetype revealing in art structures has been performed by Durand (1921-2012) in the middle of the XXth century [7]. This research was based on the reflexology of Bekhterev, Jung's psychotherapy statistics, and the seminars “Eranos” (see [7] and refs. therein). The Durand's concept is completely compatible with the systemic approach [4] currently used in the theory of architecture research. It refers to the triad of the thinking and modalities as the base. This triad involves the imagination process, the subject, and the object of imagination. Within the Durand's concept, this triad confronts the absolutely opposite (with respect to imagination) concept, i.e., “the time is death” [7]. An analysis of imagination modes leads to the inference that they are based on both, psychological as well as physiological mechanisms of perception and interpreting the physical laws and phenomena of the material world. From the viewpoint of Durand, anthropological structures of imagination, i.e., the process of architectural forming appears to be essentially the result of the mode geometrization. Neural networks and physiological basis of Durand's concept involves ancient archetypes of spatial imagination. It consists of three basic imagination modes. The first one is the postulated imagination mode corresponding to a social thinking [8]. The main physiological mechanisms of the postulated mode correspond to the instinct “toward the goal”, the extrapolation instinct, etc. Spatial geometrization of postulated mode is based on biomechanical functions of the skeletal musculature, vestibular apparatus, on the peculiarities of interaction between individuals. In the triad

of Vitruvius [11], the postulated corresponds to the “benefit”, as well as to the “function” (see Fig. 4). The form depends on its purpose. This concept includes the aggregate of social meanings of the form and its ideology as indirect function providing the social certainty of the form.

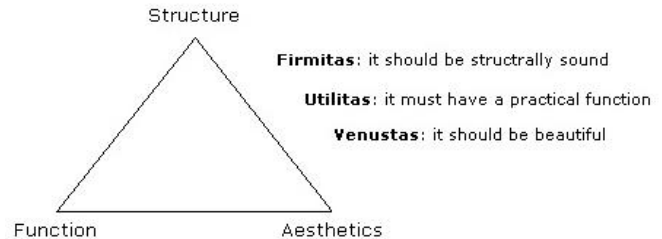

Figure 4. Vitruvian triad.

The scheme for geometrization of postulated imagination in architectural form becomes a structural frame for the dynamic and static axes. This mode is based on the geometrization of the uprightness instinct and the resistance to gravity (tectonics, in analogy to “gravitational forming”). Postulated basis underlies the parametric descriptions of the boundaries of objects and spaces, as a subject of social agreement. The same refers as well to movement representation in general, including the spatial element connection scheme, functional routes, etc.

The formal and semantic bases of the postulated mode of spatial imagination are linked with geometric metaphors of physical phenomena, such as configuration of force fields, momenta, trajectories, lines of forces, directions, points of force application, etc. Visual representation of these metaphors is very close to mathematical concepts in a symbolic graphic form used in natural sciences since Euclid's “Elements”. So, postulated elements of the spatial imagination are inspired by anatomic proprioceptive signals (receptors in the muscles, tendons, joints) and corresponding excitation in the neuron ensemble. This statement could be illustrated by the project of Toyo Ito [13] with the plan based on a math concept (Voronoi diagram, see Fig. 5). Implementation of the postulated imagination in the architectural form occurs in the structure static and dynamic (tonic) axes, manifests itself in a gradient distribution of visual masses along these axes. The digestive mode of imagination corresponds to the ontogenetic modality of thinking. The digestive mode is based on the physiological food instinct, i.e., the need for potential energy for building systems. This is similar to individual growth of a particular organism (the ontogenesis process).

The digestive metaphor in the architecture could be associated with the mass. In the triad of Vitruvius (Fig. 4) “Utilitas, Firmitas, Venustas” [12], it actually corresponds to the “structure”; the same is the “strength”.

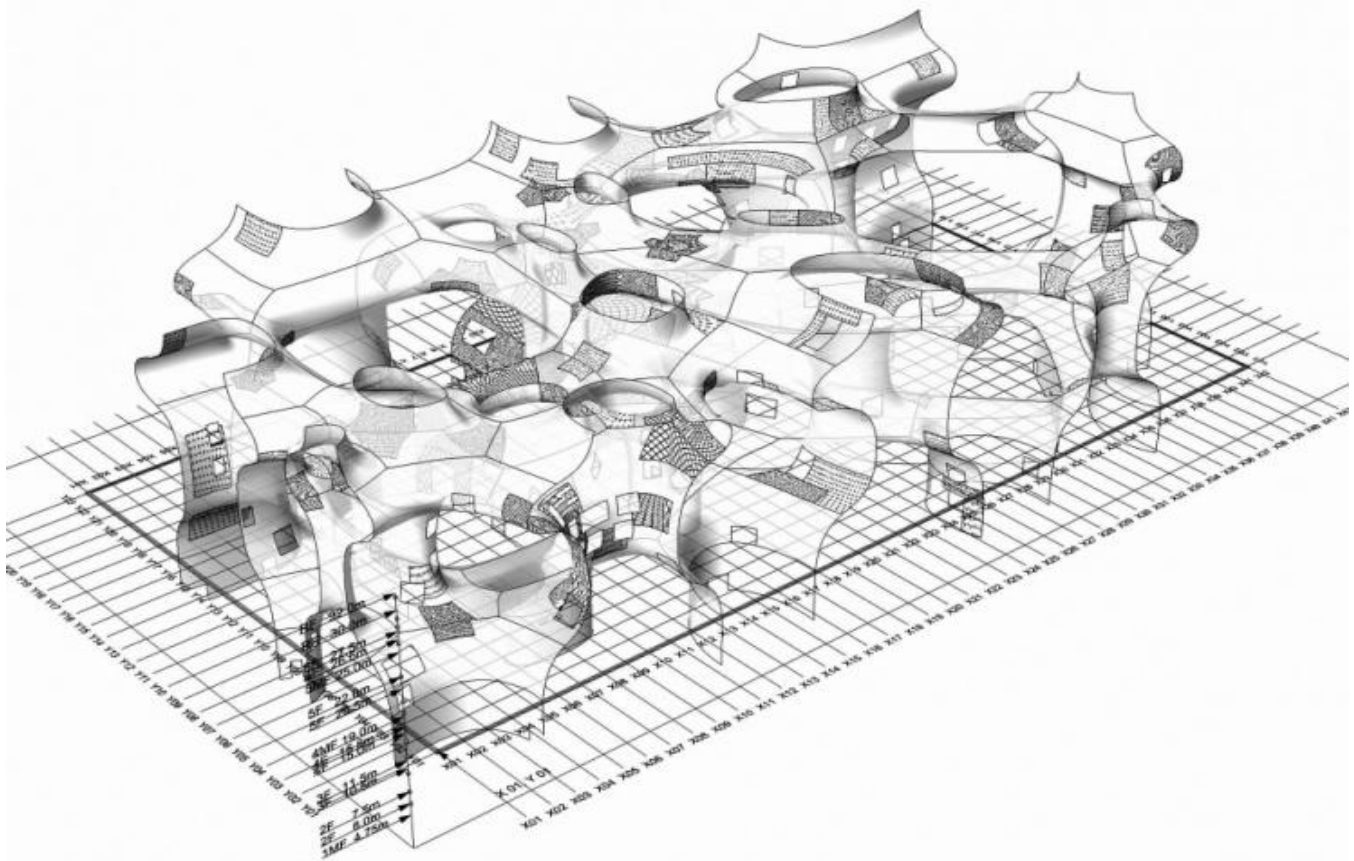

Figure 5. The Toyo Ito project of the National Taichung Theater [12].

The digestive mode represents the constructive definiteness of the form. The basis of the mental representations of the “mass” is a material body or, in a broader sense, matter in a condensed state. Anatomically, the digestive mode is controlled by the interceptive signals (from receptors of internal organs) to the Central Nervous System (CNS). Implementation of the digestive imagination mode is realized in the mass and space ratio of architectural forms. The copulative imagination mode should be interpreted more broadly as a regime of change, organizing rhythms, divisions, intervals, and fluctuations in the proportions of mass and space. Durand’s copulative mode implies that an imagination is inherent to the human physiological processes of higher nervous activity, biophysics, phylogenetics, i.e., anthropogenic modality of thinking. The semantic subtext of rhythm is a manifestation of the most important property of life, i.e., the changes. The copulative mode highlights the difference between psychological states (joy, sorrow, etc.) as functional transition from one process to another one, from one mode to the next one, and affects the psychophysiology.

General physical sense and the archetype of the copulative imagination mode is the wave, i.e., the oscillatory nature of the matter in general, including

biological and physiological processes (the electro genesis in CNS). In the triad of Vitruvius, the manifestation of copulative imagination mode is expressed by the term “aesthetics”. Physiologically, this mode is based on the signals from exteceptive receptors (coetaneous, visual, auditory, olfactory ones), subconscious internal perception of electro genesis (alternating currents) of the brain and CNS, and low energy electromagnetic fields of the body cells. The thesis “primary characteristic of architectural masterpiece is the space” [2] corresponds to the antithesis of the imagination triad as an objective source “the time is death”. The time (under the relativity) and the death (biological or cultural memory termination) exist in the physical sense only where any substance is presented, i.e., the substance in a condensed state, or the biological life. The imagination modes control the space as objective (i.e., existing regardless of imagination) reality. An artistic metaphor “time as death” is opposite to the notion of “Mass” as emptiness or vacuum, i.e., something that is opposite to the human beings.

A single natural-scientific source of discoveries and “white spots” of the theory of composition is called by the term “physiomimetics”. It was introduced by R. Soar and D. Andreen [14] for modeling the spatial structures for

buildings by analogy with the molecular lattices. But this term reflects the core of all methodological techniques of architectural forming, in line with the fundamental and applied physics (in math models), not only bionics (Fig.6).

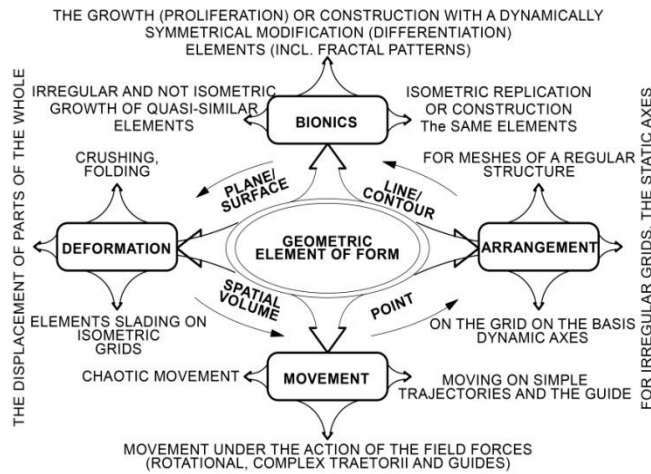

Figure 6. Interrelation and integration between phisiomimetical methods and the principles of architecture forming.

B. Durand's concept and Anokhin's "Cognitom"

Architectural forms represent the systemic encoded visual "information" in stereo-metric elements of the form/space, reflecting the multidimensional data from the highest physiological functions.

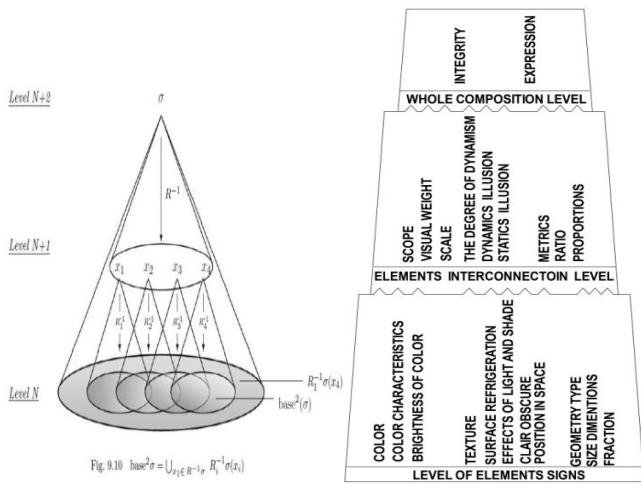

Figure 7. Comparison of the "cognitom" formalization according to Anokhin [15] and the hierarchy of formal composition properties.

At the same time, the functions work as filters and are included into the conversion mechanisms (see Figs. 6, 7, 8). The triad of imagination is a three-step statement, which corresponds to the graphs structure of "cognition", i.e. a hype network brain model proposed by K. Anokhin [15].

Similar interconnection exists between the "cognitom" formalization of the architecture of mind and the hierarchy of formal composition properties [16] (see Fig. 7). The highest level usually represents typical patterns, compositions (ARCHItypes), the lowest collects primary visual elements (extraception stimulus and arhetypes), and the middle one includes instruments of interconnection of elements (intraception archetypes).

IV. DURAND'S CONCEPT AND UKHTOMSKY'S DOMINANCE

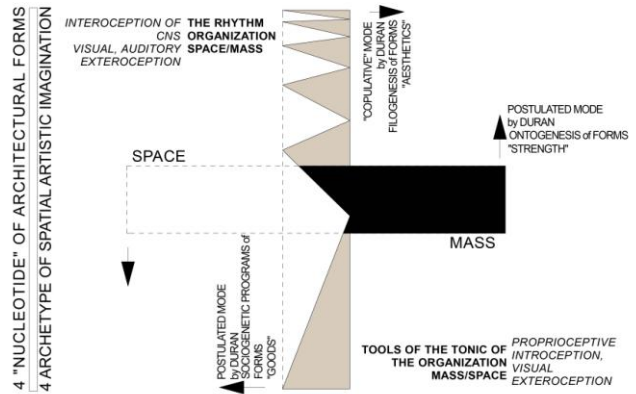

Figure 8. Complementary pairs of four "nucleatides" of architecture form and complementary pairs.

Interesting results come from the consideration of architecture history as the homological sets of various forms. The architectural form itself becomes a derivative of the four spatial operators, which are geometrical representations of abstract neural networks and physiological associations (see Fig. 9). The system of higher mental functions is controlled by a dynamic dominance. According to Ukhtomsky [11], the principle of dominance is applicable to the strategies of visual perception, which were studied by Arnheim [15]. The dominance might serve as the most determining factor integrating feelings in the process of visual perception into the whole picture-"gestalt".

The linguistic approach [6] to architecture is unable to explain, how a suite of primary geometric elements transform into the "enigmatic signifier" [5]. The way of transmission of multidimensional data of elements into the symbolic form of architecture is the actual problem of the architectural theory.

Any threedimensional form can be represented as a vector field model. The model's complexity depends on the forming paradigm. The change of paradigms is connected with revolutions of scientific knowledge, which implies that the science changes the ideology of art [17]. Consideration of the archetypical imagination modes in the light of physiology and the hypothesis on bi-similar basis of spatial imagination (see Fig. 1, Table I) leads to a natural-science concept of the geometrical imagination. This implies that

there is mutual reflection of the conscious- (ARCHItypes) and subconscious-level (archetypes) regularities, phenomena, principles of matter organization in living and nonliving nature (see Fig. 6). This concept explains the hypothesis of supra-modality of visual art and music according to Korsakova-Kreyn [18].

The dominance is also controlled by the experiences and beliefs, as well as by the physiology. According to Maslow [19], the pyramid of self-censorship reflects the "upward" sequence of dominances from the lowest to the highest level. Durand repeated Ukhtomsky regarding the concept of an art. Three functional modes of imagination, i.e., digestive, copulative, and postulated ones, could be called as the mass mode; the metro-rhythmic mode; and the tonic-axis mode of the architectural structure. The concept "the time is death" transforms into the mode of space-time. The proof of interrelation between the dominance principle and

the geometry forming could be provided by representation of the ontological categories of architecture (i.e., function, design, style, etc.) as a set of connected parameters.

Ancient Egyptian architecture describes the mass prevalence. The Gothic and Baroque architecture actualizes the vertical elements and also tonic curved elements with actual dynamic axis, which reveals the prevalence of the postulated mode. The analysis of actual for each style set of formal parameters gives the sequence of imagination modes in the history of architecture, which is equal to the structure of pyramid of self-censorship according to Maslow (see Fig. 9). The projection of this concept onto the forming process gives an understanding of the form scale as a consequence of interaction of copulative and digestive imagination modes (see Figs. 8, 9). The archetypes and manifestations of the anthropomorphic scale vs. socio scale (Neolithic community had about 30-40 people) emerged in the Neolithic period.

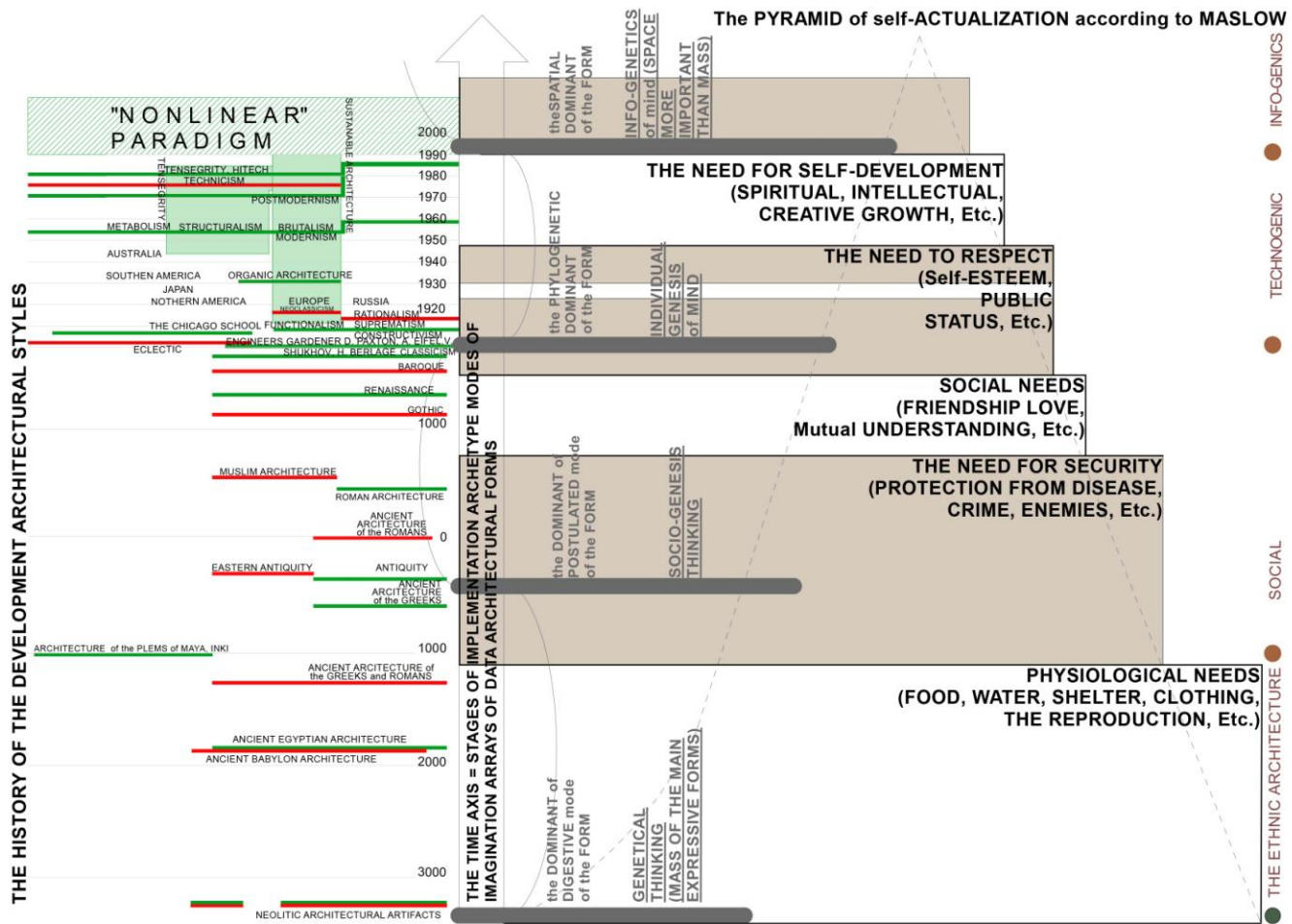

Figure 9. Comparison Preliminary graphical analysis of the actualization of imagination modes in the history of architecture.



## V. PATTERN SIGNIFICANCE AS THE DOMINANT MANIFESTATION AND THE REACTIONS OF THE CORE FOR THE ARCHITECTURAL FORM.

### A. *The Problem of Paradigms and new signifiers in Architecture. History of Architectural forms as the History of Emotions and Metaphors.*

We have met the fact of integration of design, architecture, visual arts and scientific progress that changed the whole concept of architectural forming into so-called nonlinear dynamics paradigm. It is a new kind of aesthetic metaphor. The metaphor principle according to Burke [20] is that makes the emotional experience socially shared. Starting from modern cognitive studies, the author shows that the metaphor in general is born from bodily experience. Schemes of space-time orientations, sensory and motor functions, and cardiovascular reactions to stimuli of the external world become metaphors. According to Burke, the body generates figurative languages of description, and is generated by them. "... Physiological facts are permeated with cultural signifiers. They become an integral part of the physiological system itself as value" [20, p. 70]. The natural meanings are inseparable here from the social, semiotic and historical ones. Proceeding from this mutual conditionality, the researcher identifies several successive discursive regimes, each of which has its own stock of metaphors. E.g., the humoral theory, which existed in European culture until the 19th century, presupposed a bodily unclosedness, the absence of clear boundaries between the zones of the material and mental, on the one hand, and between the individual body and the surrounding world, on the other. The language of "humors" is the language of tides, outflows and flows, that blur metric limits of personal space.

Metric radial limits for different perception types of spaces are stable: 1.5-2 meters for personal one, 6-15 meters for small group, 25-30 meters for large groups, 130-150 meters for public halls spaces. 200 meters lie over direct perception, 1200 m surpass individual perception.

The decline of the "humoral regime" brought new figurative descriptions, "more mechanistic and invasive," based on the notion of an "individualized" and "isolated" body. The architectural and spatial environment of the city is full of symbols and metaphors encoded in geometric forms and elements woven into the structure of the composition. How much a symbol can be perceived as a stimulus for neural and physiological reactions? Can the spatial environment cause stress reaction or reduce it and due to which factors or qualities of architectural form?

### B. *The geometric structure and planning of the city and stress reactions.*

The rigidity of a geometrically ordered spatial environment increases individual stress reaction. a certain number of factors in relation to urban fabric transport design, fatigue and number of accidents are not taken into account in the design.

An interesting example of such a study is the stress chart of the lower one made in 2014 by the results of work [21] by a research group led by Professor S. Parin [21], the head of the psychophysiology laboratory of the Nizhny Novgorod State University named after Lobachevsky. The research gives the answer for causes of accidents and driver's panics during a route, the map of stressful zones of the Nizhny Novgorod city. The main problem marker is the rhythm of the heart of motorists (see Fig. 10).



Figure 10. The map of stressful zones of the Nizhny Novgorod city developed by S. Parin's group of the Nizhny Novgorod State University [21,22], (extracted from [21]), available at: <http://stressmap.ru/>.

It is clear that without cooperation with architects scientists psycho physiologists can't produce even on the basis of the analysis of the most extensive database redevelopment of the spatial environment and the transport map of the city. This is a complex multidisciplinary task.

Architects, in turn, need to improve their skills and quality of design solutions within direct knowledge of stress factors discovered by psycho physiologists in the city area, which is rich in distances surpassing individual perception.

One of the important and universal factors of chronic stress in the city is the density of the population. We can convince ourselves that people around us do not affect us. But strangers' faces, crowding, smells, emotions strongly affect the hormonal system.

Standard stress reactions are triggered in most mammal populations with increasing density. The effect of the "population density factor" is the same in all studied, cases with different birds and mammals. It got a term so-called "overpopulation". Increasing density and increased frequency of contacts between individuals causes a stressful state that reduces fertility and increases mortality. The dependence of adrenal weight (producing cortisol and adrenaline) on the density of natural populations has been established for animals.

Similar facts are there in human society. E.g., the New York police gives an information that the number of crimes in skyscrapers increases almost in proportion to their height.

If in three-story houses are committed 8.8 crimes per thousand people. That ratio arises up to 20.2 in sixteen-storey houses. Also, citizens there often suffer from all sorts of mental disorders, such as anxious neurosis and affective disorder more than in three-story houses.

The connection between the activity of the adrenal weight and population density has been proven scientifically. The more a person lives in a larger settlement, the more the tonsil activates in response to stress. Note that it is more important not to live all the time, but to grow up in the village for a healthy psyche. Since the child's age is critical for neurogenesis. It is a simple way to reduce chronic stress and the proper development of the brain in children. Here it is necessary to establish experimentally whether the sense of stress is related to the density of urban development, its structure, the monotony of the city's visual grid fields.

Despite a great deal of talk about systems, we continue to organize cities as if they were a collection of isolated parts and not an integrated union of habitat, offices, plants, energy and transport routs, water, soils, land, forests, biota, and air: "Cities happen to be problems in organized complexity present situations in which a half-dozen or even several dozen quantities are all varying simultaneously and in subtly interconnected ways" [23]. The challenge is to reveal the research based opportunities how to transform urban complexity based on an industrial model for automobiles, sprawl, and economic growth into coherent, civil, and self-organizing human environments. In order to develop this human-oriented approach is necessary to find opportunities to enhance living conditions in cities, and research the relationship between humans and the formal geometry parameters of surrounding forms and environments, and the interaction between the two.

### C. *The geometruc structure as the humanity metaphor.*

A number of similar questions about the geometric structure as the humanity metaphor are discussed in the book written by C. Ellard "Habitat. How architecture affects our behavior and well-being." [23]: "Streets and buildings had been designed in accordance with universal and functional requirements and ignored the innate human need for sensory diversity were a tempting and economical solution".

But Ellard adds that a reasonable approach to the design of city streets and buildings according to the human nature is to use visual complexity as much as possible. So, this complexity needs to be natural and harmonious. But modern architects and their clients need objective measured parameters of this harmony.

The interaction of the disciplines would reduce the chances of repeating such architectural stories as the 1950s Pruitt-Igoe housing complex in St Louis, Missouri. 33 featureless apartment blocks by architect M. Yamasaki, responsible for the World Trade Center, became notorious for social dysfunction. Critics argued that the wide open

spaces between the blocks of modernist high-rises discouraged a sense of community as crime rates started to rise. Pruitt-Igoe housing complex was demolished in 1972 but wasn't an outlier. The lack of behavioral insight behind the modernist housing projects of that era, with their sense of isolation from the wider community and ill-conceived public spaces, made many of them feel as a factory not for humans.

Thanks to psychological studies, we have a much better idea of the kind of urban environments that people like or find stimulating. Some of these studies have attempted to measure subjects' physiological responses *in situ*, using wearable devices such as bracelets that monitor skin conductance (a marker of physiological arousal), smart phone apps that ask subjects about their emotional state, and electroencephalogram (EEG) headsets that measure brain activity relating to mental states and mood.

Signifier and signifying of architectural form has become a kind of fundamental problem now, a source of affordances, atmosphere and mood. On one hand there is stable permanent structural symbols and patterns, integrated into traditional architectural form, such as cross in the Christian temples [24]. On the other, there are changeable elements of non stable patterns, which cause mysterious signifiers and defense on geometrical parameters at the same time. These parameters during a long period of time depended on the main epoch style.

### D. *The neiral persepction of architectural forms: experiments and practice.*

To research the perception processes of different architectural geometry types neuroscience and anthropology integrates with eye tracking headsets, giving new research possibilities – test elements or environments themselves in virtual reality (VR) with a full suite of equipment, from eye tracking to GSR, EEG, ECG, (f)EMG, etc. It gives new opportunities of seamless real world testing – test inside the building, public spaces, in-car, on the street and many more real world scenarios with entirely new and immersive custom stimuli for the accurate instrumental detection of reactions to it.

Studies using fMRI showed that contemplation of architectural masterpieces of the brain causes changes similar to the same in meditation. It is proved that contemplation of architectural masterpieces reduces internal dialogue and improves attention, the functions of the prefrontal cortex, activates the occipital lobe, the precentral gyrus.

fMRI allows establishing that the brain response to conventional buildings and architectural masterpieces varies significantly. There are many ways in the diversity of research means with which they assess how comfortable a person feels in the city: to track the direction of his sight, palpitation, the state of the nervous system, gait and speed of movement, finally, his brain activity. All these data are then analyzed to reveal patterns and understand how

various elements of the environment affect one's health, mood and efficiency.

Dr. J. Bermudez [25] of Academy of Neuroscience for Architecture suggested that look at the buildings that were deliberately created for contemplation - museums, churches, libraries. Public spaces can have a measurable positive effect on the psychological state of a person. Bermudez leaded the study to determine the effect of architecture on the human brain. His team use fMRI and work to turn contemporary cultural manifestation of the city, i.e. the "phenomenology of urban architecture", into observations of neurology, the results of which can be used by designers and city builders. Bermudez focused on buildings and places designed for contemplation and put forward a theory that the presence of "contemplative architecture" can over time produce the positive effect on health as traditional meditation with fewer efforts on the part of the individual.

Contemplative architecture contains the same design solutions that were used in religious architecture. Bermudez noted that it is logical to use the connection between the created beauty and personal experiences for ritual purposes. This connection can be intentionally used in places intended for contemplation or research of any nature: mystical, personal and even scientific. During the experiment, 12 architects were shown pictures where were buildings themselves and their individual parts, from the facade to the interior. The buildings intended for contemplation and simple structures were demonstrated. As a result, researchers were able to observe the brain activity of people who imagined that they were in the places shown by scientists. All tested subjects were architects, white men, right-handers, who had no meditation practice before. A similar selection was made to ensure that the studies were uniform, as the Bermudez team wanted to be sure that the results of the scan would not be affected by any factors other than the pictures themselves, in particular: gender, race, education, and hand use for writing. E.g., scanning the brain of a right-hander and a left-hander performing an identical task gives different results.

The strict control over the suite of the experiment increases the chances of achieving the final result. Architects were the logical choice for experiment, because, their trained look and experience make them more sensitive to the details of architecture that the layman will overlook.

Problems began when scientists set out to measure only a few subjects. They conduct online studies in Spain and England in order to collect evidence of the unusual experience of contemplating architecture, or the facts of collision with places whose appearance radically changes the state of mind. It is especially important that most of the buildings and places mentioned in 2,982 cases were designed for contemplation: spiritual, aesthetic, religious or symbolic, which allows researchers to conclude that "buildings can cause deep, transformative states of

contemplation, and those buildings that were created for contemplation are the most successful" to a greater extent. In addition to churches, mosques and other religious buildings, some art galleries, monuments, houses and museums are examples of contemplative constructions: Guggenheim in Bilbao, the Louvre in Paris, Frank Lloyd Wright's Home at Fowlingwater are three of the top ten most mentioned objects in research. Dr. Bermúdez expanded their research using the results of neurobiological works, making significant amendments. His group of scientists attracted data on the mental states generated by the person himself, which are easily reproduced in the laboratory, and about the activity that occurs in the frontal cortex when test object makes a judgment about whether or not what is beautiful is in front of him.

The Bermudez team expected that the experience of "contemplating architecture" would be strong, and the extra-esthetic experience would reveal activity in those parts of the brain that are associated with emotion and pleasure, and not in the frontal cortex. The presence of external stimuli (pictures of buildings) also eliminates the tedious self-regulation that occurs in the frontal cortex during traditional meditation. A survey of 12 subjects showed that "weakening of attention dispersion, increasing concentration and deepening of experience appeared in all subjects; also common to all was the emergence of aesthetic judgments, apparently inevitable. Preliminary conclusions suggest that the brain behaves differently in the case of the contemplative and unreflective architecture. The state of contemplation caused by the "architectural aesthetics" in something similar to the state of traditional meditation, but with varies.

In general, the members of the American Academy of Neuroscience for Architecture also discuss ambitious design of architecture matters and details of the studies. That matters are the optimal height of interior spaces for various cognitive functions, the best design of the city to identify our research capabilities and simplify the search processes. The ways of solving problems has much in common with the base of the European "healing architecture" [1, 26].

In the native nature, which makes it so pleasant to look at, there are no straight lines. Non-natural city forms have straight lines, orthogonal outlines. So, the question arises, how different is the perception of visual series of rectilinear, orthogonal forms, arbitrary rectilinear contours or nature-like forms with curvilinear outlines?

It is very important to check the role and variety of psychophysiological impacts that proportions and fractals used in order of architectural forms give to the visual perception.

Fechner's test was static and flat, it didn't take into account three-dimensional forms and spaces. Visual perception is associated with a linear perspective and distortion of the properties. The application of the golden section affects the result in Fechner's experiment.



Proportions are found in nature, science, art, and architecture since the Ancient Greece epoch. The “golden” section accompanies all living things. Inanimate nature does not know what a “golden section” is, but undestroyed forms of inanimate nature are based on the Pythagorean Theorem, that is closely connected with the “silver” section.

There are mathematical fractal matrices, which got the name of “silver” section because of math connection with the famous “golden” section, which is known as the universal manifestation of natural structural harmony. This proportion mystically accompanies all living things. These proportions could be find in the bends of sea shells, and in the form of flowers, and in the guise of beetles, and in a beautiful human body.

It gives the variety of the mathematical fractal matrices based on the sequence of square roots of integers and integers. The “golden” and “silver” matrices have recurrence formulae. They are not arbitrary but have clear math order. So, we got another experiment task that is practical perception value of proportions.

Another important point in of visual perception research is the difference in the influence of the same proportional series that are used in structures of different types. I.e., is there a kind of the direct proportion psychophysiological impact? Does it depend on the ratio of proportions, and on the type of structure?

Arbitrary proportions of buildings and their parts also affect our perception. Is this affect negative or not? Is it better using the golden section and other proportions, the better it is perceived?

Different kinds of fractals are now popular in the architectural forming. They also give a kind of proportion ratio series.

Therefore, it is necessary to understand if the perception of the proportions of this mathematical series applied in different things and opposite areas of life and culture, in particular, in architectural forming is stable everywhere?

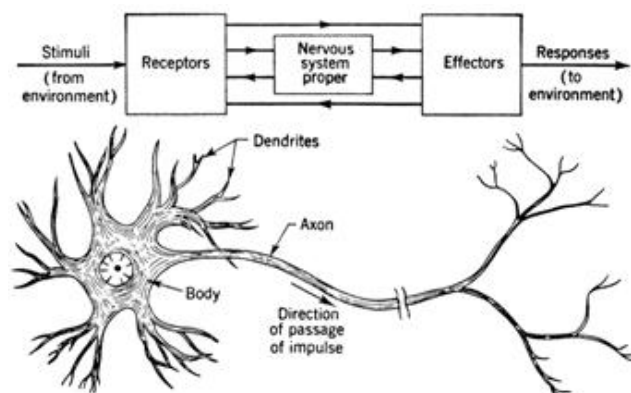

Figure 11. The scheme of perception and the structure of the neuron (extracted from [27,p.16]).

#### E. The brain mechanisms for visual perception analysis.

Professor M. Arbib [27] is researching brain mechanisms linking vision to action and language. He started from “What the Frog’s Eye Tells the Frog’s Brain” [27] via U. Pallasmaa’s “The Thinking Hand” [28] to get a new observe on how the brain links imagination to construction via sketching, whether by hand or on a computer [27, 28]. In recent years, this question has morphed into two major and connected with each other concerns about the conversation between neuroscience and architecture, and the conversation between computer science and neuroscience. This problem was discussed in the book “How the Brain Got Language” [28]. But we suppose that the basis of representation for any spatial structure in the mind is pattern, made of the frame containing abstract proprioceptive associations as a kind of geometrical canvas. Geometric elements often constitute the basis for the habitual patterns or construct new ones. And all the formal compositional means of geometric elements and their combinations influence the range of values of the new symbol or correct the semantics of traditional one. This is the two-level psychophysiological based language of architectural forming. But the base of this language is the one that M.Arbib leads in his book [27]: the stimulus, and the receptor signal transmitted to the central nervous system, the signal processing and the response to the environmental challenge in the form of an effectors’ work (see fig. 11) But the knowledge of the physiological mechanisms of the operation of CNS slightly reveals the curtain of the mystery of the cognitive processes of the brain, the work of the mind.

Therefore, the work of philosophers, anthropologists and the statistics collected by them, just like the empirical experience collected by the architects cannot be ignored when compiling a list of necessary experiments in the course of cognitive research for the purposes of architectural forming. Buildings and cities can affect our mood and well-being, and that specialised cells in the hippocampus region of the brain that are attuned to the geometry and arrangement of the inhabited spaces. Urban architects haven’t paid scant attention to the potential cognitive effects of the city’s inhabitants. The imperative to design something unique and individual or, on the contrary, cheap and affordable socially and economically tends to override considerations of how it might shape the behaviors of those who will live with it. It must be changed through the scientific way. R. Dalton [29] tells about both architecture and cognitive science: “There are some really good evidence-based guidelines out there how to design user-friendly buildings” [30].

J. Manpreet in his book “Designing mindspaces” [29] analyses the research method of G. Debord called psychogeography is an interdisciplinary study to understand the relationship between the design of environments and associated human emotions in detail, and further to

investigate the Philosophy of Heterotopia to apply its principles in curating positive experiences.

This interdisciplinary approach helps to theorize a framework which can help designers and architects to take advantages of the knowledge from the related fields and apply them in re-creating existing urban fabric. To understand the elements of this framework, Manpreet investigates the role of art, architecture, culture, media and technology in orchestrating urban experiences, not only to foster creativity and fresh thinking but also to inspire life in urban environments. Manpreet's approach is inspired by the Constructivist paradigm of learning. Manpreet has analyzed various examples to illustrate findings and understanding of experts and fellow researchers in related fields to arrive the methodology for final framework.

Methodology of Manpreet's research followed a human centered design process by keeping experience at the centre, and then applying system thinking to understand its core and periphery for the final framework. The proposed urban area in order to provide inputs for planning and policy making. Urban sociology should be used as a basis for creating a comprehensive programming for design of a new public space or architectural form.

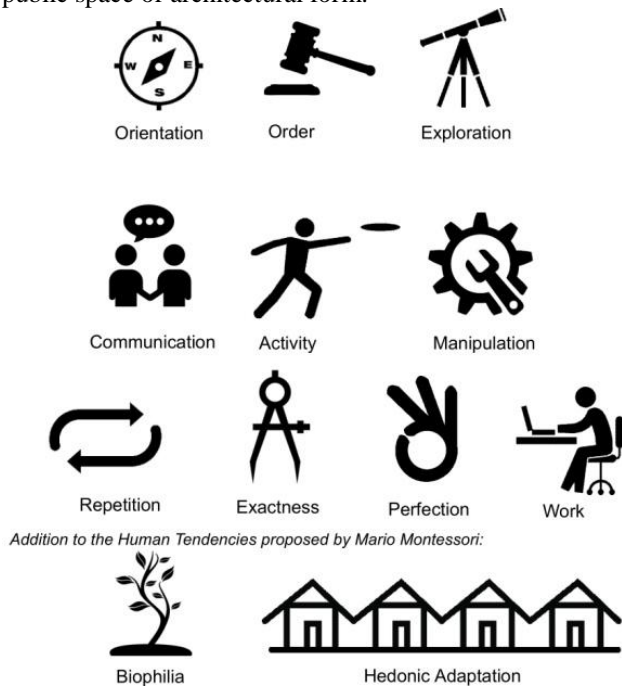

Figure 12. Visual representation for the Human tendencies is my contribution by adopting and recreating icons made by Freepik (extracted from [30, p.27])

Manfrid consider "programming" to be an important aspect of architectural design that architects and designers can use to reprogram and re-purpose any space, so as to enhance experience [29]. R. L. Hemmer programmed in 2005 a project named "Under Scan" in Lincoln, U. K., where the passersby were detected by a computerized

framework is essentially an end product of a literature review capturing the details and findings from the related fields of philosophy, cognitive architecture, and ontological design due to the architectural form of spaces.

Sussman and Hollander describe the reasons behind our attraction to edges, faces, symmetry, curves, and stories in the book about cognitive architecture [29]. Cognitive architecture is also an approach that focuses on research of the human response to the built environment. Buildings are intended to be viewed, traversed, and lived in by people. Only a handful of theoreticians and practitioners of architecture think deeply about human nature and, why and how it needs to be considered seriously during design process of buildings and urban area.

Urban sociology is the study of human interaction in metropolitan city areas and the development of society by means of urban space and design form. It is a normative discipline of sociology seeking to study the structures, processes, changes and problems of an tracking system, which activated video-portraits projected within their shadow. Virtual computer generated environments are slowly mixing our mental landscape through media architecture, test subjects were entering virtual spaces. Although real human environments have always had a layer of virtual elements in the form of printed media, paintings and art forms. The term "virtual environment" was coined with the advent of computers, and problem how to differ virtual from real had already arised.

The framework (see Fig. 13) proposed by Francis Ching in book "Form, Space and Order"[29] gives an overall idea to understand any physical or virtual environments (see Fig. 12). For the purpose of research the association of spaces or built environments and its elements with human emotions this framework is very useful, as it lays a foundation to get better understanding of the basics of architectural form.

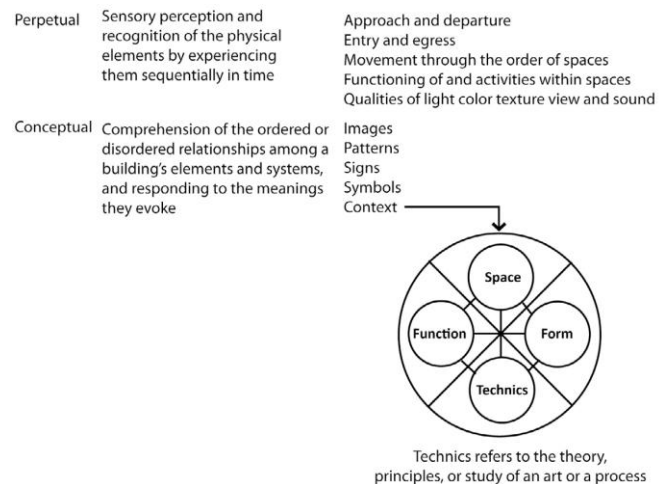

Figure 13. Illustration of the main for perception analysis part of framework for designing environments; proposed by F. Ching, "Form Space and Order" (extracted from [29, p.22]).

Manfred studies interiors of built environments in spite of the fact people disregard the type of ceiling above them and ignore the patterns on the floor, he supposes that man-made spaces around us without realization have some feeds back to shape one's behavior. So, Manfred supposes that human response to the built environment must be realised in detail with correlatoin with the time spended inside. E. g., somebody is sitting inside an office with a glass façade and his desk is positioned in a way that on a bright sunny day the sun directly shines upon his eyes through the glass wall, the uncomfortable glare one experiences may disrupt the work-plan for the day, and the same situation may get even more uncomfortable, if it is summer time and there is inadequate air-conditioning. The glass wall may be the reason of a whole day without productive work. It depends not only on lighting conditions and conditioning, but also on the boundaries and metrics of personal space, the configuration of the room, it's overall illumination, isolation, color, textures and materials.

## VI. CONSEQUENCES FOR THE FUTURE EXPERIMENTS.

### A. Finding Perception Meanings of the Structural information from the Architectural or Abstract Forms

So, the architectural form appears at the intersection of four imagination modes (see Fig. 8). The material of architectural sheaths is mass. But the primary material of artificial human environments inside the shells or between them is space. Architectural space is organized by function graphs within composition means based on axis frames and grids. They could be treated as "operators" of the three-dimensional form related to "structural information" (see Fig. 14) and semantic features.

The first aim of experiments is scientific evidence that the aesthetic quality of architecture expresses affects on human health and well-being by following means: structure and proportions of buildings, population density, and geometry or bionics character of designs for artificial environments.

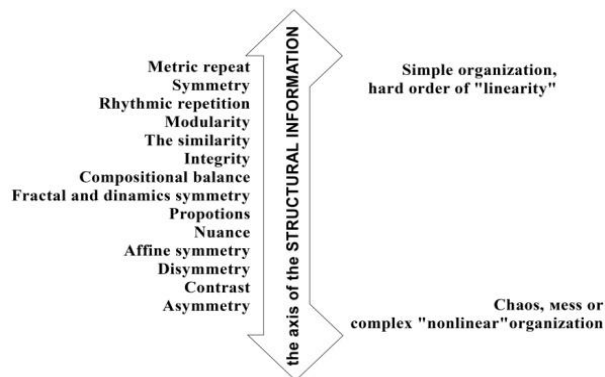

Figure 14. Structural information from the forming processes.

The second goal of experiments is to reveal a set of parameters for architectural environments or forms that influence directly test subjects groups.

The third goal of the experiment is to identify those characteristics and qualities of architectural forms and environments that have a beneficial effect on the test subjects and determine in what combinations this impact is positive. The forth additional aim is to reveal if architectural styles have some cognitive role in one's mind. It is rational to use the experience of such theorists of art and psychology and founders of the modern theory of formal composition, as G. Fechner, V. Kandinsky [30] and I. Itten [31] in experimental instrumental work.

### B. Equipment Requirements and Registration parameters

Analysis of the form as a set of parameters of archetype modes opened the way for researching dominances of emotional perception (see Fig.7). It is reasonable to combine the tracking of physiological processes (the frequency of respiration, palpitation, EEG parameters, etc.) with purely cognitive tasks associated with individual perception and spatial thinking of test subjects. Test subjects have to be logically divided into groups according to the occupation, sex, age, dominance of right-handedness or left-handedness.

### C. The List of experiments

A suite of experiments according to the previous analyses of publications must include the following groups of studies with the fixation of the physiological systems work and the objects of tested one's personal concentration:

1. Experiments based on the V. Kandinsky book "The Point and The Line on The Plane", fixing the physiological answers and the trajectories of the glance movement in response to images of abstract structures similar to those given in Kandinsky's book. The first stage is the repetition of images through the same pause or cyclicity. The second stage is a repetition through an unsystematic different duration.
2. Experiments for testing the physiological changes during the observation of the tested subject the rotation of figures (spatial and impossible) without changing the proportions. In this case, the analysis of the results should take into account the different character of the silhouette, the discrete or specific configuration of the forms.
3. Experiments on the mental rotation of the similar figures (spatial or impossible) with difference between proportions, color, texture, etc.
4. Testing the physiological changes when displaying video with different scenarios of perception of the same architectural form, as well as groups of architectural forms of different styles, groups of architectural objects that are topologically equivalent (homologous series of architectural forms).
5. Video rotation of detailed or generalized models of architectural forms with the study of fixation of tested subject's attention on structure, comparison of little changes in similar structures. The first option is to show different

images with proportions of the golden section through the same pause. The second option is to show the same structures with arbitrary proportions and different time intervals along the golden section. The third option is the display of the same structures with arbitrary proportions and different temporary arbitrary time intervals.

6. Perception of monotonous visual media and architectural fields (short and long surfaces, facades) with two stages: the repetition of images with a certain frequency and the repetition of an unsystematic and with different duration.

7. Cognitive tasks before and after the experiment. The study of the role of the part and whole symbol; dependence between the signifying of the symbol and formal characteristics; the relationship between detail and the whole; a group of experiments on the perception of generalized models of well known architectural objects.

8. The comparison of the perception of artificial three-dimensional objects with the perception of natural prototypes. It is necessary also to account the possibility of cognitive dissonance and other stress factors in the subjects' reaction, comparison of results for different age and other categories of subjects.

9. An experiment of subjective division of structural and composite forms into provocative and harmonizing, stimulating with fixing a stable effects that these forms have on neuropsychological status of the person.

10. Structural and architectural design analysis of stress map project for redevelopment of the Nizhny Novgorod city area and agglomeration.

For diagnostics of the physiological reactions, not so expensive equipment is needed, such as fMRI, the thermal imager, ECG, EEG, and the eye-tracker (to account for the attention-fixing points of the testing subjects).

## VII. CONCLUSIONS

The actual set of experimental work can give the key to the main problem of architectural theory: an understanding division of structural and composite forms into provocative and harmonizing, stimulating and tiring. And give the answer to the question if the phisiomimetics is the future of architectural forming or a kind of the neotrabalizm phenomenon.

The experiment with instrumental diagnostic care can give objective answers, unlike H. Fechner's studies, how harmful are arbitrary proportions in architectural forming. Whether arbitrary proportions affect human perception and means of forming what architects should learn from natural forms really negatively.

Experiments set by A. Shapoval answered the question of perception of contours and the silhouette of industrial design forms.

In addition, there is not highlighted in the experimental work of A. Shapoval [4] difference in the perception of bent and broken rectilinear or folded forms. The question about the effect of the curvature of the shape and the nature of the

influence of this curvature on the subject's well-being remains open.

Only empirical architectural experiments stay numerous: "I am attracted by curves, free and sensual. Those curves that we can see in mountain silhouettes, in the form of sea waves, on the body of a beloved woman"- wrote in his memoirs Oscar Niemeyer - an outstanding architect of Brazil [32]. This was a core of Niemeyer's approach to design, thanks to which all his projects amaze until our days. Simplification of the means spent for the achievement of a certain goal leads to a detachment from architectural form creative principles and to the extinction of architecture as art in general.

Only neuroscience-based research may resolve the dispute of radical functionalists and artists, because the constructions of Niemeyer remained unclaimed. Architect can add the terrain, details, such as portico, columns, bay window, decor, and coloring environment in order to get rid of the aggressive and tedious homogeneous visual fields in the city. But architect needs objective criteria to evaluate visual environments as aggressive or friendly to humanity, and to make a comparison with the research of the influence of coloring on physiology.

Another way to avoid homogeneous visual fields is the complete change of the paradigm for future architectural forms. But it also requires human oriented cognitive research.

Obviously, one main trend is already clear. The transition of mankind to urbanized environments and separation from nature requires an ecological new approach to urban design, and no new visual "ecology" of the spatial man-made environment of cities, the likening of nature, geometric balance, measure and a certain ratio of rectilinear and geomorphic surfaces in architectural forms.

That is why architectural forming is now already connected with phisiomimetics. And, also we need to develop the phisiomimetics research, as the fundamental principle of architectural forming. A series of experiments have to be connected with the phisiomimetics research because of physiological benefits of nature based aesthetics.

Harmony of the architectural form and space means not only similarity to natural forms. It's not the only way of generating forms and spaces. Similarity to nature only exaggerates and compensates the prevalence of rigid geometry in contemporary architecture and city environments. Nature teaches new ways and methods of architectural forming.

It is necessary to mark that a structure of an architectural form can be taken as a system of neural and physiologically encoded visual stimulus information. The systemic relationship between psycho physiological concepts and the theory of formal composition promises an effective experimental study. The list of experimental study proposed in this paper is not completed because it should be supplemented by wide graphic and video series of visual stimuli. A convincing chain of relations between the formal

characteristics of the architectural form as visual stimuli and neural responses is not complete.

However, the developed theoretical base guarantees not only the right direction of the experimental strategy, but also its reliability. The main aim of this study is to find clear interrelations between the geometry of architectural form and the way of emotional perception. The second aim is to establish an interrelation between emotional reactions and phisiomimetical patterns of forming to reveal possible new ways in architecture forming. The third goal is to clarify possible new directions in architectural education, methods, strategies, necessary new disciplines, etc. However, the greatest difficulty of the forthcoming work will be precisely the analysis of the experimental data. An interesting perspective is the connection of parametric modeling of an architectural form and neuroscience-based strategies for its design, but is such a connection possible? This question will be answered only by further research.

#### ACKNOWLEDGMENT

The author expresses great gratitude for the consultations with Professors S. Parin and O. Chernavskaya and advises of Dr. Thorsten Gressling.

#### REFERENCES

- [1] Chebereva O. "Problems of the System Approach to the Study of Psychophysiology of Aesthetic Emotions Concerning an Architecture", COGNITIVE 2018 (The Tenth International Conference on Advanced Cognitive Technologies and Applications : February 18-22, 2018, Barcelona, Spain) AIRIA XPS Press 2018. Available from: [http://www.thinkmind.org/index.php?view=article&articleid=cognitive\\_2018\\_2\\_10\\_48003](http://www.thinkmind.org/index.php?view=article&articleid=cognitive_2018_2_10_48003) Retrieved 2018.08.31
- [2] L. Azizyan, I. Dobritsyna, G. Lebedeva. Theory of composition as a poetics of architecture. Moscow: Progress-Tradition, 2002.
- [3] Y. Yankovskaya. "The architectural composition and semiotics are the genesis of ideas", Architecton: news from universities, vol. 7, 2004. Available from [http://archvuz.ru/2004\\_2/3](http://archvuz.ru/2004_2/3) . Retrieved 2018.08.31
- [4] A. Shapoval. The Theory of Formal Composition: A Textbook for Universities. Kazan Design quarter. 2016.
- [5] Cr. Alexander. A pattern language. Towns. Buildings. Construction. Oxford University Press. 1977.
- [6] Ch. A. Jencks. The New Paradigm in Architecture. Yale University Press. 2002.
- [7] G. Durand. Les structures antropologiques de l'imaginaire. Paris: Dunod, 1992.
- [8] J. D. Lewis-Williams, "Discussion and Criticism. on Vision and Power in the Neolithic: Evidence from the Decorated Monuments", Current Antropology, vol. 34(1), pp. 55-56, 1993.
- [9] "Paleolithic paintings in El Castillo cave in Northern Spain. Uranium-series dating reveals Iberian paintings are Europe's oldest cave art", University of Bristol news. vol. 14, 2012. Available from <http://www.bris.ac.uk/news/2012/8560.html>. Retrieved 2018.08.31
- [10] "Pablo Picasso Asemic line drawing". Available from: <http://seks-ua.blogspot.ru/2013/10/pablo-picasso-asemic-line-drawing.htm> Retrieved 2018.08.31
- [11] E.Y.Zueva and K.B. Zueva. The Concept of Dominance by A.A. Ukhtomsky and Anticipation. Springer International Publishing Switzerland, 2015.
- [12] V. Mako. Architecture and Ideology. Cambridge Scholars Publishing, 2014.
- [13] Toyo Ito & Associates: Architects, Projects. Available from [http://toyo-ito.co.jp/WWW/Project\\_Descript/2015-/2015-p\\_04/2015-p\\_04\\_en.html](http://toyo-ito.co.jp/WWW/Project_Descript/2015-/2015-p_04/2015-p_04_en.html) Retrieved 2018.08.31
- [14] R. Soar and D. Andreen , "The Role of Additive Manufacturing and Physiometric Computational Design for Digital Construction ", Architectural Design, Vol. 82(2), pp. 126–135, 2012.
- [15] K. Anokhin. "Cognitom is a hyper-network model of a dump", Lecture given in Kurchatov Institute. Available from: <http://neuroinfo.ru/conf/Content/Presentations/Anokhin2015.pdf>. Retrieved 2018.08.31
- [16] R. Anheim. Art and visusal perception: A pichology of the creative eye. University of California press. Berkeley and Los Andgeles, California, 1997.
- [17] L. Shlain. Art and phisics: parallel visions in space, time, and light. New York: W. Morrow & Company, Inc., 1991
- [18] M. Korsakova-Kreyn and W. J. Dowling, "Emotional Processing Music: Study in Affective Responses to Tonal Modulationin Controlled Harmonic Progressions and Real Music", Psychomusicology: Music, Mind and Brain, vol. 24(1), pp. 4/20, 2014.
- [19] Abraham H. and Maslow. Motivation and Personality (2<sup>nd</sup> ed.) N.Y.: Harper & Row, 1970.
- [20] Bourke J. The Story of Pain: From Prayer to Painkillers. Oxford; N.Y.: Oxford University Press, 2014.
- [21] "Dangers of the city - in the heart rhythm of motorists. Scientists clearly showed the old problem", NN.RU.: Nizhny Novgorod online. 28.03.2015. Available from: [https://m.nn.ru/news/gorod/2015/03/28/opasnosti\\_goroda\\_v\\_serdechnom\\_ritme\\_avtomobilistov/](https://m.nn.ru/news/gorod/2015/03/28/opasnosti_goroda_v_serdechnom_ritme_avtomobilistov/) until 2017. Retrieved 2018.08.31
- [22] S. Parin, S. Polevaya, A. Polavaya, "A Neurochemical Framework to Stress and the Role of the Endogenous Opioid System in the Control of Healf Rate Variability for Cognitive Load" Proc. of COGNITIVE 2017: The Ninth International Conference on Advanced Cognitive Tecnologies and Applications, pp. 16-20, Copyright ©IARIA, 2017., 2017.
- [23] Ellard C. Habitat. How architecture affects our behavior and well-being. University of Waterloo (Canada), 2015. The Bukowski Agency Ltd and The Van Lear Agency LLC
- [24] Schenk, J. (2012) The cult of the Cross in the Order of the Temple. In: As Ordens Militares: Freires, Guerreiros, Cavaleiros: Actas do VI Encontro Sobre Ordens Militares: 10 a 14 de Março de 2010. Series: Ordens militares (7). Município de Palmela, GEOS: Palmela, pp. 207-219. ISBN 9789728497569J.
- [25] Von Hoffmann E. "The Brain on Architecture"// The Atlantic. Healf./Nov 10, 2014 . Available from: <https://www.theatlantic.com/health/archive/2014/11/the-brain-on-architecture/382090/> Retrieved 2018.08.31
- [26] Lawsons B., Healing architecture, a The School of Architecture, University of Sheffield, Sheffield, UK , Arts & Health, Vol. 2, No. 2, September 2010, 95–108, DOI 10.1080/17533010903488517
- [27] Arbib M., Brains, Machines, and Mathematics. McGraw-Hill, 1964.
- [28] Pallasmaa U. The thinking Hand: Existential and Embodied Wisdom in Architecture. John Willey & Sons LTD, 2009.
- [29] Arbib M., How the Brain Got Language: The Mirror Neuron Hypothesis. Oxford University Press, Oxford, UK, 2012. <https://doi.org/10.1093/acprof:osobl/9780199896684.001.0001>

- [30] Manpreet J. Designing mindspaces. Re-inventing urban spaces by understanding. Psychology of design and philosophy of heterotopia. The hidden ways that architecture affects how you feel. San Francisco, California 94105, USA Toronto, Ontario, Canada. MDes, December 2016.
- [31] Kandinsky, W. Punkt und Linie zu Fläche: Beitrag zur Analyse der malerischen Elemente. – München: Verlag A.Langens, 1926. - SPb.: ABC-Classic, 2005. - P. 63-232.
- [32] Johannes Itten GESTALTUNG UND FORMENLEHRE. Vorkurs am Bauhaus und später. © 1963 und 1975 by Verlagsgruppe Dornier GmbH, Stuttgart.
- [33] Niemeyer Oscar. The Curves of Time. The Memoirs of Oscar Niemeyer. Phaidon Press, 2007.

## Feature Extraction from Body Postures: Towards an Emotion Recognition System Based on Digital Imaging

Bruno Barbosa, António J. R. Neves

DETI / IEETA

University of Aveiro

3810-193 Aveiro, Portugal

Email: {brunobarbosa, an}@ua.pt

Sandra C. Soares<sup>1</sup>, Isabel D. Dimas<sup>2</sup>

<sup>1</sup>CINTESIS.UA, Departamento de Educação e Psicologia

<sup>2</sup>GOVCOPP/ESTGA

University of Aveiro

3810-193 Aveiro, Portugal

Email: {sandra.soares, idimas}@ua.pt

**Abstract** — Recent advances in the study of emotions show that body expressions or body postures are also a relevant non-verbal cue for communicating emotions, with recognition rates similar to those transmitted by facial expressions. Despite the tremendous technological advances in the last decades, there are still room for improvement in the definition of how posture features can be related to different emotions, using technological solutions. This is a complex task due to the fact that it is difficult to associate an emotion with a certain posture and there are a large variety of emotions, such as, sadness, joy, anger, fear, surprise, disgust, among others. In this paper we present a computer vision system that is able to extract characteristics regarding the human body and generate data that allow the evaluation of a given posture. We propose the use of a recently developed algorithm to extract the body posture based on digital color images, which has presented optimal results in several domains, for the recognition of emotions from human body postures. Based on this algorithm, a system was developed that allows, in a non-invasive way, to extract characteristics of the human posture in order to perceive the emotions associated with each posture. We present experimental results in a real scenario, showing promising results regarding the extraction of characteristics obtained from the human body (displacements, areas and overlaps), confirming the effectiveness of the developed system.

**Keywords** - Pose Estimation; Digital Image; Emotions; Skeleton Detection.

### I. INTRODUCTION

This article is an extended version of the original paper presented at the Third International Conference on Advances in Signal, Image and Video Processing, *SIGNAL 2018* [1]. This version extends the conference paper by presenting a system developed for the extraction of characteristics of the human posture and provides experimental results on a real scenario, confirming the effectiveness of the developed system.

Emotions conveyed by facial expressions are powerful non-verbal cues for functional socio-emotional interactions. The study of body postures as another important non-verbal means to communicate emotions and behavioral intentions has been exponential in the past decade [2], particularly in the fields of cognitive, affective and social neuroscience [3][4]. Although these studies have been showing that emotion recognition performance depicted from body postures do not seem to differ from those of facial expressions, research work exploring the effectiveness of computer vision systems able to

automatically detect and classify emotional categories and dimensions from human postures are scant.

Herein, we present the state of the art regarding the development of computer vision systems for detection and classification of human body posture, including the type of existing sensors to obtain images that feed such systems and their operation, as well as human skeletal detection algorithms. We discuss the implications regarding the development of such systems for emotion detection from body posture in several contexts, in which emotions are relevant for socio-communicative purposes.

With the advancement in the study of emotions associated with body postures, it is necessary to investigate, technologically, how emotions can be extracted, non-invasively, from human postures. This is of high relevance to several areas of application, ranging from education, (e.g., posture of students in classrooms, denoting disinterest or excitement [5]), to teamwork [6] and mental health contexts (e.g., postures associated with psychopathology, such as unipolar depression [7]).

Our proposal is that, by using digital cameras and algorithms that allow to extract human body postures, postures associated with different emotional dimensions can be mapped. We present a system to extract the characteristics of the human posture that allows the detection and extraction of characteristics of these postures, in groups of individuals who are asked to freely interact in a dynamic way, thus allowing each posture to be classified according to the associated emotion. Hence, unlike the previous studies, participants will not be asked to perform specific postures that are expected to be associated with different socio-communicative patterns (e.g., expansive or constrictive) [8][9][10]. This raises the following questions: "How to use a PC and a camera to estimate the body posture of the human body?" and "How to classify each posture as being associated with certain emotional dimensions and or categories?"

This article is organized as follows: Section I gives a brief introduction and presentation of problem, in Section II the existing computer systems for the described problem are presented, Section III discusses the definition of digital image, presenting the various types of existing image sensors, in Section IV are addressed some of the existing posture detection algorithms. Section V presents the feature extraction system developed and Section VI shows the results obtained by this system. Finally, in Section VII, a conclusion is drawn based on the results and effectiveness of the system.



## II. EXISTING COMPUTATIONAL SYSTEMS FOR THE PRESENTED CONTEXT

Some work has been carried out in the development of systems for the detection and evaluation of the human body. However, no system was yet developed to allow the detection and classification to map emotions from body postures. This lack of systems' is due to the difficulty of classifying a posture. Moreover, in real life settings, the variations in postures are immense, making it difficult to infer emotions from dynamic interactions between individuals.

In [11], in a classroom context, the authors claim to provide important information to the teacher about their audience's attention. This study focused mainly on the capture of data through a camera system to detect movements, as well as the head and its orientation, thus obtaining the most significant patterns of behavior to infer this cognitive dimension (i.e., attention). However, the results failed to show a direct relationship between the movements of the students and their attention.

In [12], a system for the recognition of human actions based on posture primitives is described. This system, like [13], only focuses on perceiving/classifying if a person runs, walks, dance, etc. and not their emotions. In a learning phase, the representative parameters of posture are estimated through videos. After that, already in a classification phase, the method is used for both videos and static images. In this system, 3 disjoint problems are identified in the recognition of human action: detection of a person in the image, recognition of the posture expressed, and attribution of a category of action to its posture, the focus being the last 2 points. The results of this system are promising, resulting in a highly accurate recognition of actions, allowing us to conclude that the posture of human beings contains enough information about their activity. It is also mentioned that, the addition of other information besides posture, allows for a greater precision in the recognition of the activities.

In short, we were able to verify the existence of some systems for the recognition of posture with specific applications. However, no system is yet available to recognize and classify postures according to the emotions they are communicating.

## III. IMAGE SENSORS

Typically, a digital image is represented by a rectangular matrix of scalar vectors, composed by a finite number of elements in each position and with a certain value. These elements are called pixels [14].

A pixel is the smallest unit of an image and has an intensity value and a location associated with it. Through the joining of many pixels and due to the filtering effect of the human eye, it is possible to create illusions, like gradients and shading.

Figure 1 represents the gradient of a Red, Green and Blue (RGB) image by merging pixels.

The most common types of digital images are grayscale and RGB images. In grayscale images, the value associated with each pixel is black, white or a shade of gray, which can range, for 8 bits per pixel, from 0 to 255, where 0 is black and 255 is white. In color images, each pixel has associated with it

a red, green and blue value, which combined in different amounts can generate any color. The values of red, green and blue also vary, for 8 bits per pixel, between 0 and 255, with 0 being the black color and 255 the maximum of the respective color. Figure 2 shows an intensity matrix of a grayscale image for a given area [16].

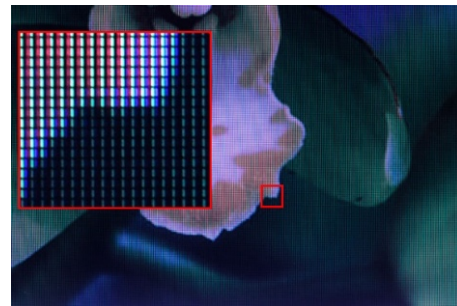

Figure 1. Gradient associated with a region of an RGB image [17].

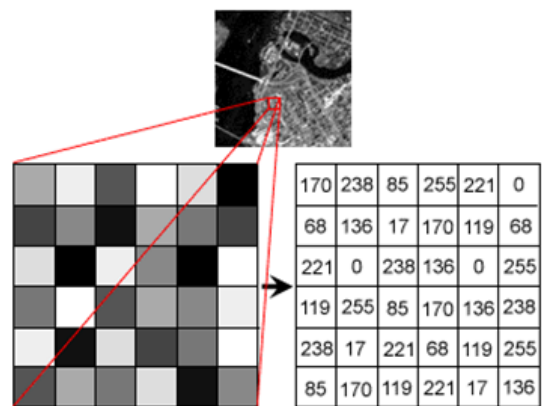

Figure 2. Matrix for a certain area of a grayscale image [18].

The resolution of a digital image depends on the size of its array, that is, with increasing number of pixels, the resolution increases. However, the processing of this matrix becomes computationally slower.

There are several types of sensors able to obtain digital images. In the next subsections, some of these types of sensors will be discussed and their operation will be explained.

### A. Image Sensors in the Visible Spectrum

For capturing digital images in the visible spectrum, mainly two types of sensors are used - the Charge-Coupled Device (CCD) and the Complementary Metal-Oxide-Semiconductor (CMOS) sensor.

Each of these sensors is composed by millions of photosensitive transducers whose function is to convert light energy into electric charge. They also have a photosensitive surface, which receives a charge of light to capture the image, so the larger the photosensitive surface, the better the image quality [19].

However, these sensors can only measure the energy of the radiation. To obtain color images, it is necessary to apply a filter that allows to target specific colors to their respective pixels. The most common filter is the Bayer filter. Figure 3 shows the operation of this type of filter.

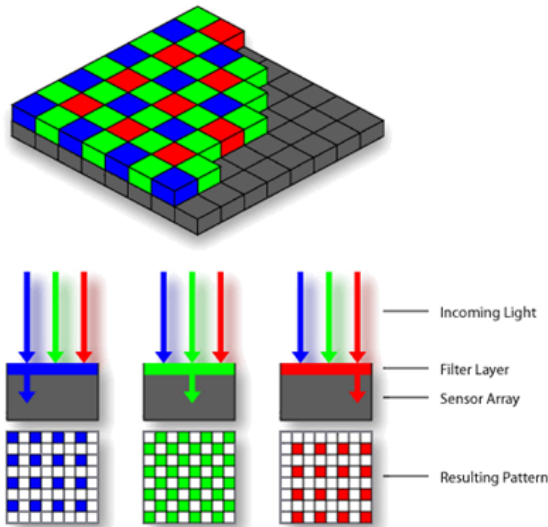

Figure 3. Application of a Bayer filter to obtain a color image [20].

The CCD sensor exists mainly in compact cameras, while the CMOS sensor is present from simple webcams and smartphone cameras to professional cameras.

Figure 4 shows an example of a CCD and CMOS sensor.



Figure 4. Example of CCD (left) and CMOS (right) sensor [21].

### B. Special Sensors

In addition to the sensors mentioned earlier, there are also special sensors that allow to obtain other information besides the color image. These sensors are especially used for image processing in special cases, such as the measure of distances and temperatures.

In the next subsections, the modes of operation of these sensors will be explained.

#### 1) Thermal

A thermal camera, unlike the cameras in the visible spectrum mentioned above, are composed of sensors capable of capturing radiation in the infrared spectrum, thus allowing the creation of an infrared image [22]. Normally, when displaying this type of images, a color table is applied so that it is possible to easily distinguish between hot and cold zones. Figure 5 shows a thermal image, obtained through a *Flir* [23] thermal camera, with the respective color table. Although this camera is commercial, it has a high cost due to its specific market and technology used in its manufacture.

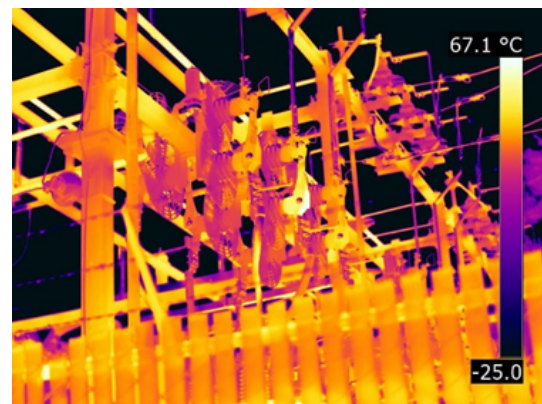

Figure 5. Example of a thermal image, obtained through a *Flir* [23] thermal camera.

This type of sensor can be used even in low-light environments, as opposed to sensors, such as CCD and CMOS [22]. There are several areas where these apply. From security, where they can be used to detect intruders even in low light situations [24], to the industry, where they can be used to detect heating problems in machines, which are not detected by the human eye [22], passing through the detection of people through the temperature of the human body [25].

#### 2) Multi/Hyper Spectral

The Multispectral and Hyperspectral sensors measure the energy in various bands of the electromagnetic spectrum. The spectral resolution is the main distinguishing factor between the images produced by these two types of sensors.

The hyperspectral sensors contain a greater number of bands with narrow wavelengths, providing a continuous measurement in all the electromagnetic spectrum, whereas the multispectral sensors usually contain between 3 and 10 bands with wide wavelengths in each pixel of the image produced [26]. This way, the images captured by a hyperspectral sensor contain more data than the images captured by multispectral sensors. In a practical context, images produced by multispectral sensors can be used, for example, to map forest areas, while images produced by hyperspectral sensors can be used to map tree species within the same forest area [27].

Figure 6 shows the comparison between multispectral and hyperspectral images.

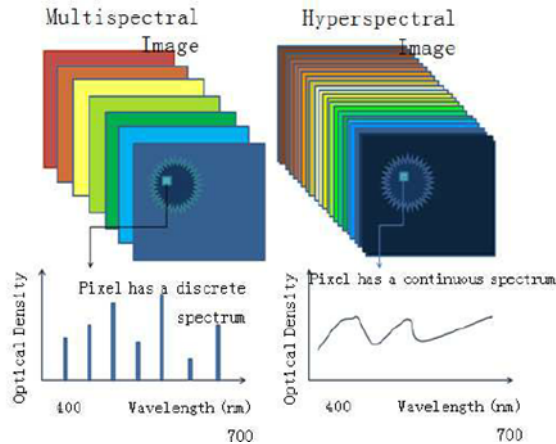

Figure 6. Comparison between a multispectral (left) and hyperspectral (right) image [28].

### 3) Distance

There are several types of distance image sensors. These types of sensors can obtain images where the closest and most distant objects are perceptible.

There are three major types of sensors, the sensors called Time Of Flight (TOF), Structured Light and Stereo. TOF sensors work on the principle of sending and receiving a signal by measuring the properties of the received signal. By determining the flight time and, consequently, through this time and the speed of the signal the distance to the object is obtained [29]. Structured Light sensors work by projecting a previously established pattern into scene, allowing the system, by capturing that same pattern, to calculate the depth of each pixel of the image received. This calculation is performed by deformation of each point of the pattern projected in combination with the original pattern [30]. Finally, the Stereo sensors allow to obtain distance image through two lenses, at a certain distance, so that the two captured images can be processed and compared, creating a 3D image [31].

## IV. ALGORITHMS FOR POSTURE DETECTION

There are many human posture detection algorithms, but few do it dynamically and in poorly controlled environments.

The main existing algorithms focus on the area of vision. This area has been increasingly explored as it allows everything to be done in a non-invasive way for the human being. Thus, devices not directly in contact with it enable the ecological validity of the actions, hence increasing the accuracy and credibility of the algorithm. In this type of algorithm, the detection is done using external objects such as flags [10], or simply through the previous teaching of the system for the intended postures [9].

A posture emerges as well as the set of 2D or 3D locations of the joints, being possible, through these locations, to assess the position and displacement of all limbs. However, the problem that is common to these algorithms relates to critical body positions, such as lying, sitting, shrunken, sideways, etc. [9][32] and in situations that involve groups of people, where

some parts of the body overlap [32]. In this type of positioning, the accuracy of these systems drops significantly.

All posture detection algorithms presented here are based on videos or a set of images collected from digital cameras. There are thus several types of cameras used with these algorithms. As described in the previous section, these cameras may differ in the type of image you can get. However, at present, the Kinect is the preferred device of most of these algorithms, since its own Software Development Kit (SDK) is one of the most used with respect to detection of the human skeleton. Kinect consists of an RGB camera, depth sensor, a three-axis accelerometer, a tilt motor and a microphone vector [33]. Thus, it is possible to obtain, with only one device, different types of images. Figure 7 shows the various components of a Kinect.

As mentioned previously, its software, Kinect Skeletal Tracking, is widely used in the detection of the human skeleton, which is carried out in three steps. In the first, an analysis, per pixel, is made to detect and classify body parts; in a second phase, a global centroid is found to define the joints of the body; finally, a mapping of the joints is done, so that they fit into a human skeleton, through data previously known about the human skeleton [34]. Figure 8 shows the steps explained above.

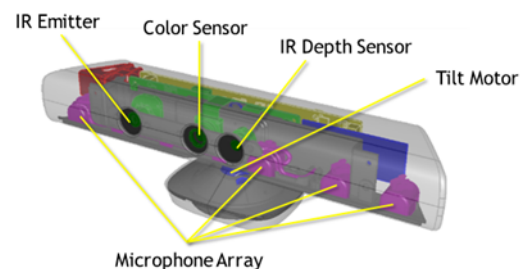

Figure 7. Hardware Configuration of a Kinect Device [35].

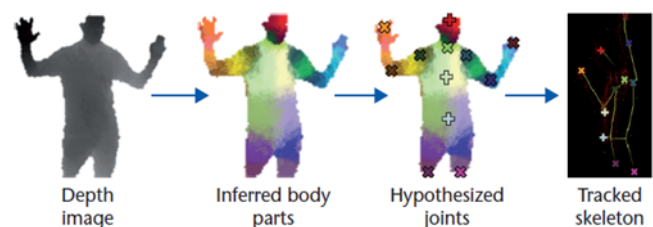

Figure 8. Detection steps of the Human Skeleton through the Kinect Skeletal Tracker Software [34].

In April 2017, the OpenPose library [36] was launched. Using only RGB images, this library can detect and extract 2D values from the main parts of the human body. With this library, it is possible to perform a detection of body, face and hands, in a total of 130 possible keypoints, 15 or 18 of them for body parts, 21 for each hand and 70 for the face.

For body detection, one of two data sets are used: Common Objects in Context (COCO) or MPII Human pose dataset, with people images, annotated with the human skeleton, still being



used CMU Panoptic dataset during the development of the algorithm, since it contains about 65 sequences of approximately 5 hours and 30 minutes and 1.5 million 3D skeletons available. This detection is done through the approach described in [32], where a neural network is used to simultaneously predict confidence maps for body part detection (Figure 9b) and affinity fields for association of parts of the body (see Figure 9c), this process being done in several steps, so that this detection is credible.

Next, a set of two-part combinations is performed to associate the body parts, where a score is used to define which person belongs to the respective part and to make a correct connection of the parts in each person in the image/frame (Figure 9d). Through this approach, it is possible to detect several people in the image and define their posture. Finally, with a greedy inference algorithm, all parts are connected and the 2D points are defined for each of the joints (Figure 9e).

In [37][38], there are presented approaches of detection multiple human skeletons in simple RGB images with efficient results, however they fall short of [32].

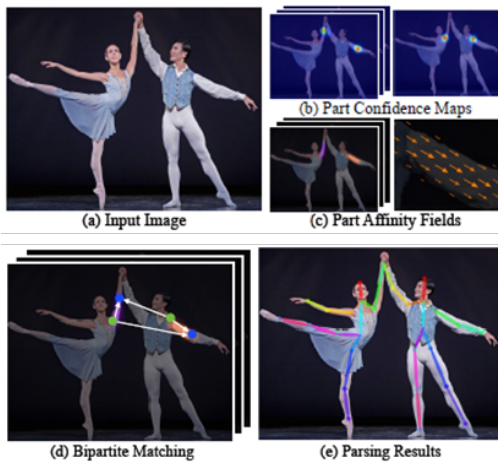

Figure 9. Detection of the Human Skeleton through the OpenPose library [32].

### V. SYSTEM FOR FEATURES EXTRACTION OF HUMAN POSTURE

In this paper we propose a system to extract the characteristics of the human posture contributing to the presented technological gap for the presented context. The system was developed based on the use of the OpenPose algorithm and RGB images to detect the human body posture and extract characteristics necessary for its analysis so that the associated emotions are perceived. The features extracted by this system are occupied area, body displacement and overlap/interactions between people.

This system is divided into several parts. Initially, the points of interest are extracted from the body of each person present in the image under analysis. Then, using these same points of interest, the characteristics are extracted, starting with the occupied area by the body of the person in question, displacement of body parts over time and, finally, overlaps between the people present in the images over time.

#### A. Points of Interest

Points of interest reflect each joint of the human body being detected up to 18 joints by OpenPose library. In this way, the initial step of the developed system starts by processing the video files, frame by frame, through this library. As an output of the processing, results a set of JavaScript Object Notation (JSON) files relative to the points of interest detected in each frame, as well as a video where the detected postures are presented in each frame of the same. JSON files are structured through value lists with pairs (key/value), making it simple, fast and efficient to process the information contained in them.

Each file contains all points of interest relative to the persons found in the respective frame, in form of x, y, c, x, y, c, ..., where x and y represent the coordinates of each joint and c represents the percentage of confidence that the algorithm has on the previous coordinates, in the order defined in the library and which is shown in Figure 10.

An excerpt of one of the files generated by the library is shown in Figure 11, where the result can be verified for the first person detected in the respective frame this file.

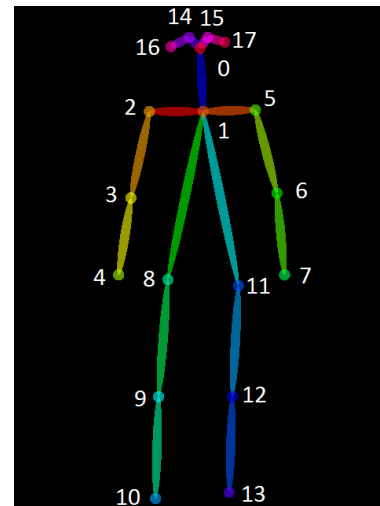

Figure 10. Image representative of the order of points of interest defined by the OpenPose library [39].

```

{
  "version": 1.0,
  "people": [
    {
      "pose_keypoints": [
        428.587, 205.398, 0.868436,
        444.239, 219.774, 0.866439,
        415.569, 221.048, 0.85868,
        410.345, 256.31, 0.88299,
        402.514, 285.016, 0.809752,
        472.992, 218.448, 0.769775,
        483.402, 258.94, 0.427595,
        499.069, 275.946, 0.103947,
        432.533, 295.47, 0.276504,
        0, 0, 0,
        0, 0, 0,
        463.816, 298.106, 0.256644,
        0, 0, 0,
        0, 0, 0,
        423.385, 200.186, 0.901855,
        433.834, 201.468, 0.910918,
        0, 0, 0,
        453.338, 198.905, 0.797334
      ]
    }
  ]
}
    
```

Figure 11. Excerpt from a JSON point of interest file generated by the OpenPose library.

### B. Occupied Area

Using the JSON files obtained above, containing the values of the 2D positions of the main parts of the human body, we obtain the maximum and minimum x and y values of each person and, by using these values, it is possible to calculate the width, height and, consequently, the occupied area by the person. This procedure is done for all people in the frame under review. After obtaining these maximum and minimum values, bounding boxes around each person are drawn, so that it is possible to verify the results obtained by visual inspection.

Graphs are created to visually observe the evolution of occupied areas over time by each person. These graphs will be shown and explained in the Results section.

### C. Displacements

The displacement values are calculated for each part of the body, individually. The body parts (vectors) are defined by a pair of points of interest representing two connected body joints, in a total of 13 vectors, as shown in Figure 12.

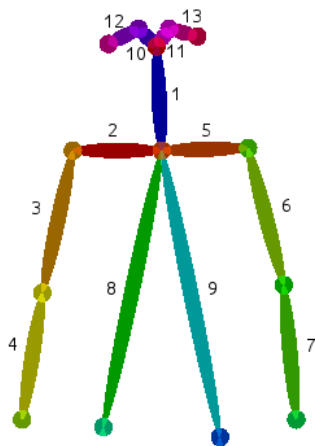

Figure 12. Representation of the vectors associated with the 13 parts of the study body.

The calculation is done frame by frame, analyzing the current and previous frame. In this way, it is possible, by calculating the Euclidean distance, to determine the displacement, relative to time, of each vector. However, there is the problem of failure to detect some points of interest in some of the frames. If this problem occurs, then the value of the last detection of the point of interest in question is saved and the calculation made once it is detected again. Thus, it is still possible to calculate the displacement velocity by dividing the distance by the value of the interval of frames in which the vector was not found.

The values relative to the distance are stored in files respecting the increasing order of the vector number, finally writing the frame number and the area occupied by the person. If it is not possible to calculate any of the vectors in the frame in question, then a '-' is placed in its position. With these values graphs that allow to visually observe the evolution of the displacements over time are generated. These graphs will be shown and explained in Section VI.

### D. Overlays

Once persons are identified, the overlaps between them are studied, in order to gauge a possible interaction between the elements of the group. Detection of overlaps involves the estimation of a depth value, since all values obtained are 2D. Thus, a cycle is made that allows to perform a check between all possible combinations of people, two by two. The estimate is based on the minimum and maximum values of x and y of the two persons to be compared, as well as the values of x and y of the upper limbs of each.

This estimation starts by checking for overlap between the two bounding boxes. If it does not exist then it is assumed, immediately, that there is no overlap. If it exists, a possible overlap is assumed. However, there are no guarantees yet, since a precise depth estimate has not yet been made. To increase the certainty in the estimation it is verified that the distance between the maximum values of y of the two bounding boxes is relatively small. If not, then it is assumed that the two persons are not in the same plane at z and, consequently, assume a non-overlap / interaction. If so, then the level of confidence in relation to the overlap increases, and there is already an estimate of depth. To further increase certainty in the detection the opening of the upper limbs of each person is verified and, if these openings are identical, it is verified if the area of the two bounding boxes is identical. If it is not, the estimate is ended with a possible low confidence interaction. If it is, the confidence increases, and it is checked again if the distance in y of the two bounding boxes is even closer, in order to increase even more the level of confidence. In this way it is possible to make a relatively precise depth estimate so that possible overlaps/interactions are detected. Figure 13 graphically represents the detection of an overlap.

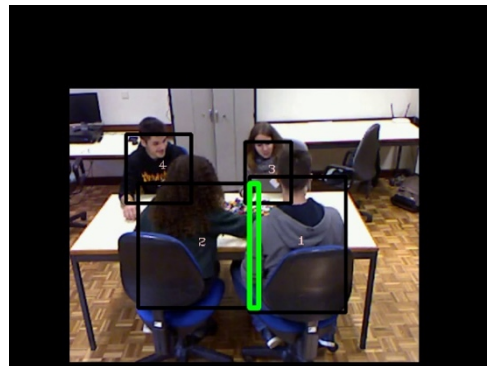

Figure 13. Graphic representation of an overlay.

With the overlaps found, heatmaps are created that allow to perceive visually the regions where there was a greater number of interactions / overlays. A heatmap is a graphical representation of data, where values are represented by a color scale.

The creation of the heatmap is done through a matrix that is zeroed and has the same size as the images under study. Whenever there is a possible overlap, all values relating to the overlapping region in the matrix are incremented. At the end all values are converted to a scale from 0 to 255 where a

colorMap is used to distinguish zones with more interactions (red) from zones with less interactions (blue). In the Results section, examples of heatmaps obtained will be presented.

## VI. RESULTS

To test the developed system, videos obtained through a study at the Department of Education and Psychology of the University of Aveiro, entitled "Conflict, emotions and efficacy in work teams: an experimental study" were used. This study consists of several sessions, where each session involves 4 participants in interaction around a table.

The experimental phase of each session consists of two steps, which involve two construction tasks (with legos) that must be performed in a group. The first task focuses on the construction of a horse, taking the participants 15 minutes to be performed. The second task is to construct a spacecraft, and the participants should begin by presenting and discussing the individual ideas for the next plan together, in order to decide how to proceed, with 5 minutes to do so. After the 5 minutes of discussion, 20 minutes are given for the construction of the spacecraft.

The experiments carried out can be related to two types of conditions: the control condition, where no conflict is induced and the goal is to evaluate how the emergence of conflicts and the associated emotions influence the functioning of the work teams; the condition of task conflict, where for the second task are given dubious and complex instructions.

In the results presented below, for the characteristics: occupied area and displacements were generated graphs that are divided in two parts, where the first part refers to the first phase of the experiment and the second part referring to the second phase of the experiment. Figure 14 represents the division made. In this way it is possible to analyze the behavior change of each participant according to the condition tested.

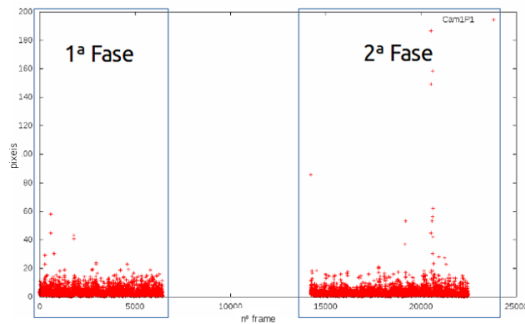

Figure 14. Division of the graphs obtained by the two phases of the experiment.

### A. Occupied Area

To observe the variation of occupied area by each participant, graphs were created with the data obtained through the processing of the videos obtained. Thus, it is possible to verify if participant changed their posture between the two phases of the experiment, occupying more or less space. Figures 15, 16, 17 and 18 show the graphs relating to the area

of the participants during an experiment in which it was not induced any conflict.

Figures 19, 20, 21 and 22 show the graphs relating to the area of the participants during an experiment in which the task conflict was induced. By observing these graphs, it is verified that the variation of the area between the two phases of the experiment is, on average, greater when there is an induction of conflict.

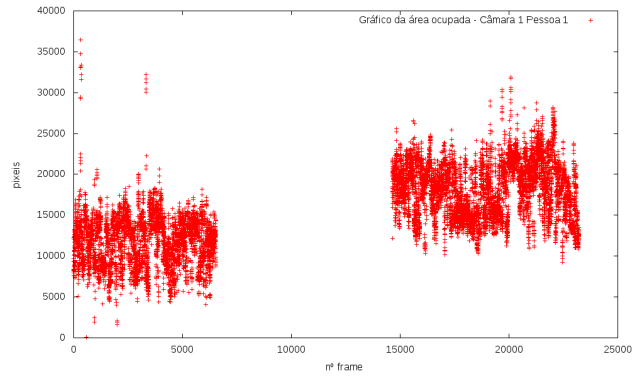

Figure 15. Graph relative to the occupied area by the person with id 1 in an experiment without inducing conflict (12/13/2017).

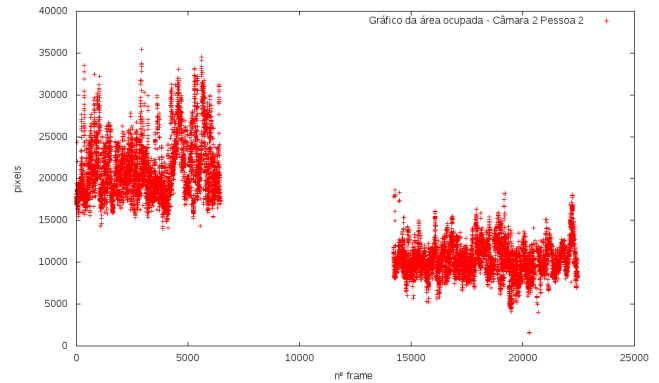

Figure 16. Graph relative to the occupied area by the person with id 2 in an experiment without inducing conflict (12/13/2017).

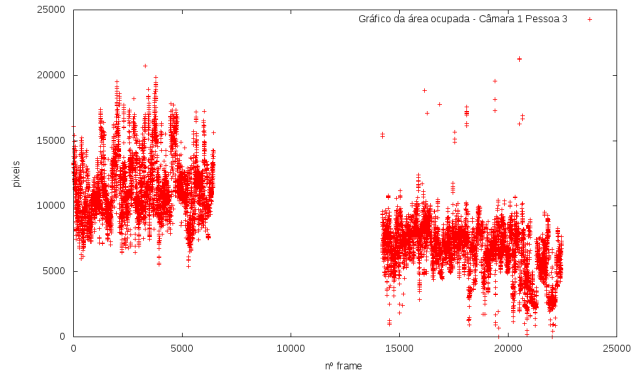

Figure 17. Graph relative to the occupied area by the person with id 3 in an experiment without inducing conflict (12/13/2017).

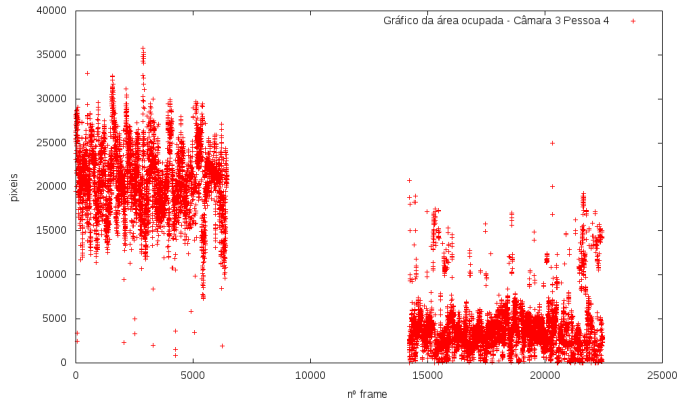

Figure 18. Graph relative to the occupied area by the person with id 4 in an experiment without inducing conflict (12/13/2017).

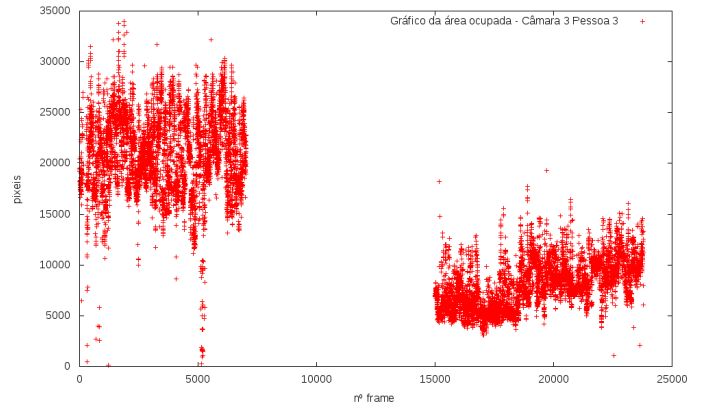

Figure 21. Graph relative to the occupied area by the person with id 3 in an experiment with induction of task conflict (12/15/2017).

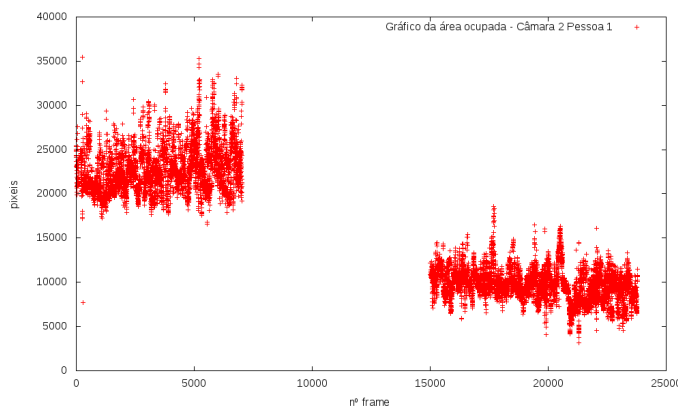

Figure 19. Graph relative to the occupied area by the person with id 1 in an experiment with induction of task conflict (12/15/2017).

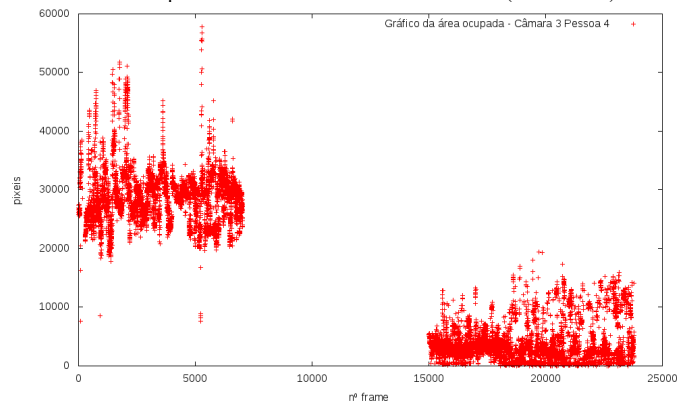

Figure 22. Graph relative to the occupied area by the person with id 4 in an experiment with induction of task conflict (12/15/2017).

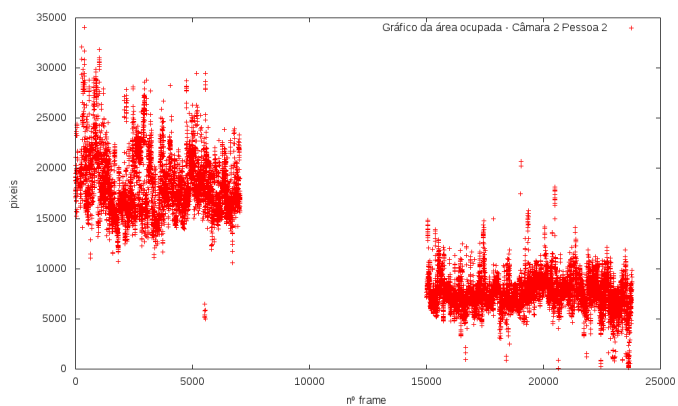

Figure 20. Graph relative to the occupied area by the person with id 2 in an experiment with induction of task conflict (12/15/2017).

### B. Displacements

To verify the evolution of the displacements, we draw graphs that demonstrate the values of the displacements in each frame. These values can be related to each vector or the average of all vectors found.

Figures 23, 24, 25 and 26 show the graphs relating to the movement of participants in an experience where was not induced any conflict. Figures 27, 28, 29 and 30 show the graphs relating to the movement of the participants during an experiment in which the task conflict was induced. By observing these graphs, it is observed that, although small, there is a greater difference of movement between the two phases of the experience when there is induction of conflict.



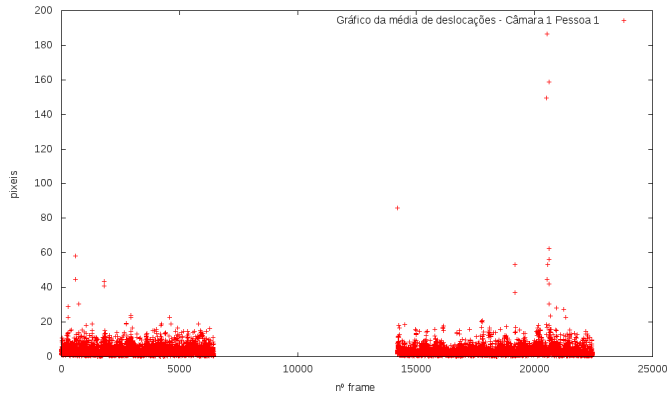

Figure 23. Graph on the average displacements of the person with id 1 in an experiment without inducing conflict (12/13/2017).

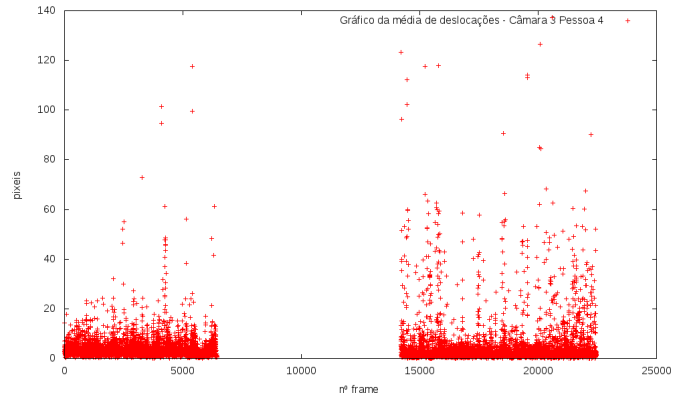

Figure 26. Graph on the average displacements of the person with id 4 in an experiment without inducing conflict (12/13/2017).

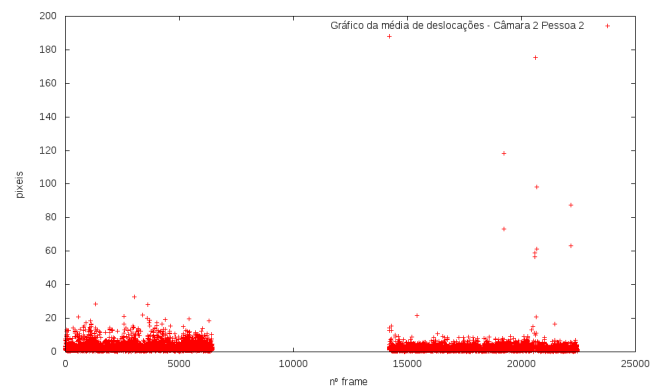

Figure 24. Graph on the average displacements of the person with id 2 in an experiment without inducing conflict (12/13/2017).

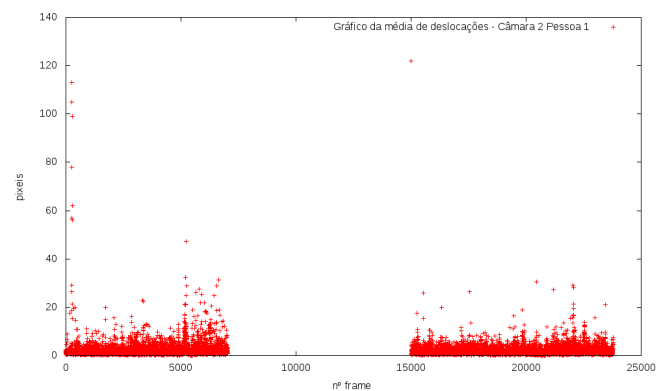

Figure 27. Graph on the average displacements of the person with id 1 in an experiment with induction of task conflict (12/15/2017).

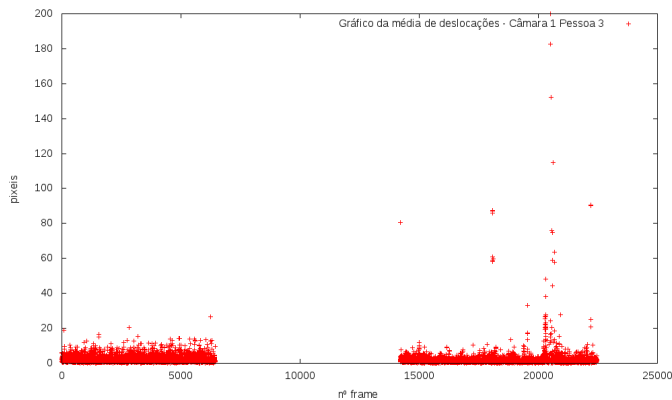

Figure 25. Graph on the average displacements of the person with id 3 in an experiment without inducing conflict (12/13/2017).

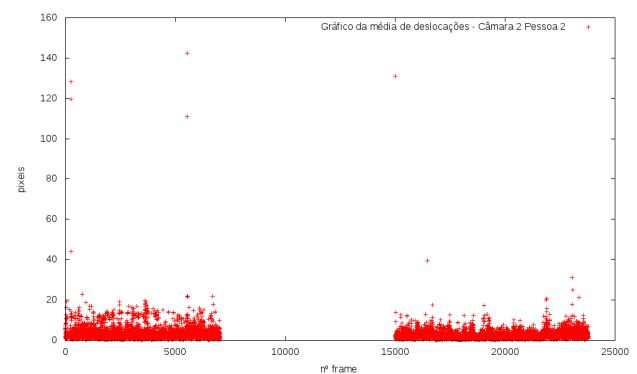

Figure 28. Graph on the average displacements of the person with id 2 in an experiment with induction of task conflict (12/15/2017).

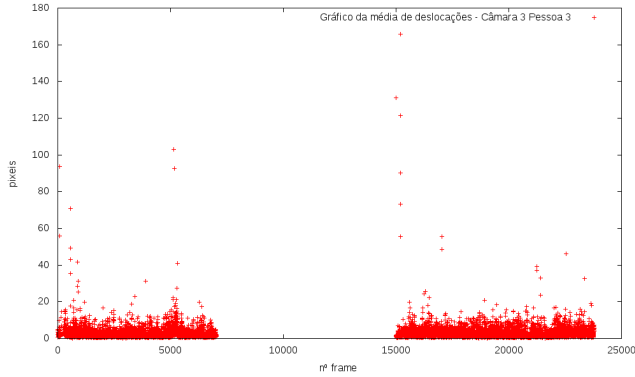

Figure 29. Graph on the average displacements of the person with id 3 in an experiment with induction of task conflict (12/15/2017).

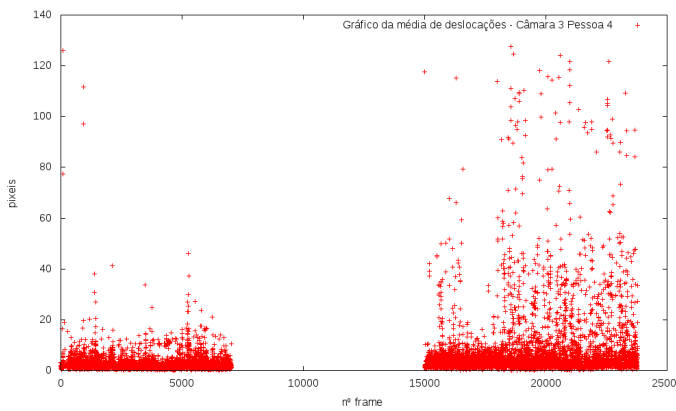

Figure 30. Graph on the average displacements of the person with id 4 in an experiment with induction of task conflict (12/15/2017).

**C. Overlays**

Finally, to be able to observe the level of interaction between participants, heatmaps were created in each experiment. Thus, it is possible to verify which participants have more interaction, i.e., it can be shown which were the ones that played a more important role during the same. By observing each heatmap, it is possible to quickly verify the areas with the highest interaction, although some minimal errors occur in the identification of people during the detection process.

For example, when looking at Figures 31, 32, and 33, it turns out that people 1 and 2 were the ones that most interacted. Already people 3 and 4 had a much lower number of interactions. Comparing Figures 31, 32, and 33, which relate to an experimental condition where no conflict was induced, with Figures 34, 35, and 36, which relate to a condition where task conflict was induced, it can be observed that the number of interactions/overlaps is higher when there is induction of task conflict.



Figure 31. Heatmap relative to camera 1 in an experiment without inducing conflict (12/13/2017).

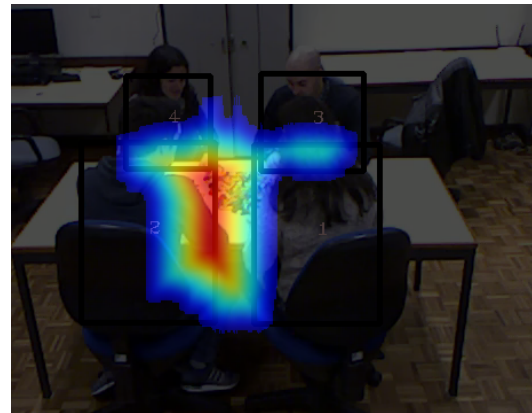

Figure 32. Heatmap relative to camera 2 in an experiment without inducing conflict (12/13/2017).

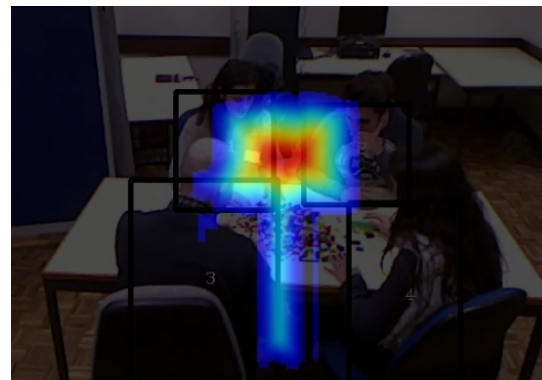

Figure 33. Heatmap relative to camera 3 in an experiment without inducing conflict (12/13/2017).



Figure 34. Heatmap relative to camera 1 in an experiment with task conflict induction (12/15/2017).

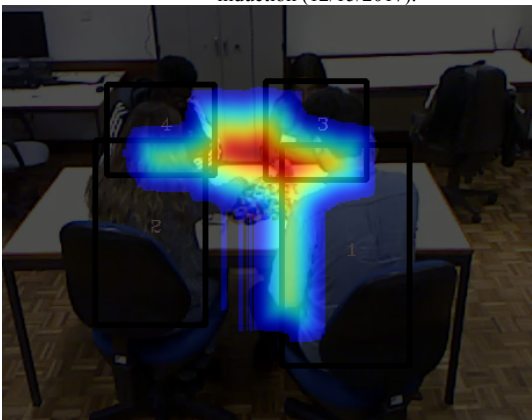

Figure 35. Heatmap relative to camera 2 in an experiment with task conflict induction (12/15/2017).

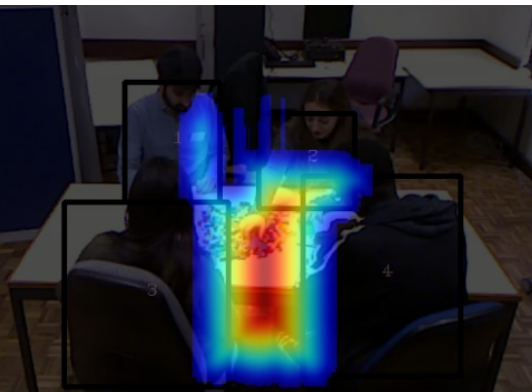

Figure 36. Heatmap relative to camera 3 in an experiment with task conflict induction (12/15/2017).

## VII. CONCLUSION

In the presented state of the art, it is possible to recognize the lack of systems for the detection and classification of emotion systems from human body postures, as well as the difficulties associated to the already existing systems.

However, there are many image sensor's alternatives, allowing to guide the system to several types of solutions, from skeleton detection based on distance image to the detection based on RGB image.

The Human Posture Detection algorithms research work [32] presents the algorithm with better results at all levels, which is possibly what will be used in the development of a system to allow the recognition of emotions from human body postures. This solution is not only optimal for its simplicity in terms of image, but also for its good results in detecting postures in groups of people. However, for this algorithm to work properly, it is necessary to have specific and expensive hardware, due to the parallel computing used and the GPU calculation performed.

With the developed system it was possible to perceive that characteristics can be extracted allowing to assess the postures and associated emotions. As an example, looking at a graph relative to the area occupied by a person during an experiment can be concluded if the same assumed a more contracted or expansive posture, which is associated with negative and positive emotions, respectively. Looking further at a graph relating to movement of the joints of the body it is possible to deduce if the person is more or less confident. Importantly, thought, future studies should further develop emotion categorization via body postures regarding other emotional conditions (e.g., in fear contexts), using technological solutions. The use of such ubiquitous solutions for a variety of emotions may be of great value to determine the individual emotional experience more objectively and, ultimately, enable adaptations in the context (e.g., a classroom) to enhance well-being, particularly when these reflect a negative valence.

Finally, through the observation of the created heatmaps, the level of interactions between the participants could be directly related to the amount of movement and the posture assumed by each one, that is, if individual A moved very little, so it will have few interactions. On the other hand, if two individuals B and C, which are side by side, have moved a lot, then the interactions in that zone will be high.

## VIII. ACKNOWLEDGMENT

This work was partially funded by FEDER (Programa Operacional Factores de Competitividade - COMPETE), by National Funds through the FCT - Foundation for Science and Technology in the context of the project UID/CEC/00127/2013 and by the Integrated Programme of SR&TD "SOCA" (Ref. CENTRO-01-0145-FEDER-000010), co-funded by Centro 2020 program, Portugal 2020, European Union, through the European Regional Development Fund.

## IX. REFERENCES

- [1] B. Barbosa, A. J. R. Neves, S. C. Soares, I. D. Dimas, C. Ua, and D. De Educação, "Analysis of Emotions from Body Postures Based on Digital Imaging," in Proc. *SIGNAL 2018*, The Third International Conference on Advances in Signal, Image and Video Processing, pp. 73–78, 2018.

- [2] B. de Gelder, A. W. de Borst, and R. Watson, "The perception of emotion in body expressions," *Wiley Interdiscip. Rev. Cogn. Sci.*, vol. 6, no. 2, pp. 149–158, 2014.
- [3] A. P. Atkinson, W. H. Dittrich, A. J. Gemmell, and A. W. Young, "Emotion perception from dynamic and static body expressions in point-light and full-light displays," *Perception*, vol. 33, pp. 717–746, 2004.
- [4] W. H. Dittrich, T. Troscianko, S. E. G. Lea, and D. Morgan, "Perception of Emotion from Dynamic Point-Light Displays Represented in Dance," *Perception*, vol. 25, no. 6, pp. 727–738, Jun. 1996.
- [5] E. Babad, "Teaching and nonverbal behaviour in the classroom," in *International Handbook of Research on Teachers and Teaching*, Boston, MA: Springer US, 2009, pp. 817–827.
- [6] H. A. Elfenbein, J. T. Polzer, and N. Ambady, "Team Emotion Recognition Accuracy and Team Performance," *Research on Emotion in Organizations*, vol. 3, pp. 87–119, 2007.
- [7] F. Loi, J. G. Vaidya, and S. Paradiso, "Recognition of emotion from body language among patients with unipolar depression," *Psychiatry Res.*, vol. 209, no. 1, pp. 40–49, Aug. 2013.
- [8] T.-L. L. Le, M.-Q. Q. Nguyen, and T.-T.-M. T. M. Nguyen, "Human posture recognition using human skeleton provided by Kinect," *2013 Int. Conf. Comput. Manag. Telecommun.*, pp. 340–345, 2013.
- [9] Z. Zhang, Y. Liu, A. Li, and M. Wang, "A Novel Method for User-Defined Human Posture Recognition Using Kinect," *Int. Congr. Image Signal Process.*, pp. 736–740, 2014.
- [10] C. W. Chang, M. Da Nian, Y. F. Chen, C. H. Chi, and C. W. Tao, "Design of a Kinect Sensor Based Posture Recognition System," *2014 Tenth Int. Conf. Intell. Inf. Hiding Multimed. Signal Process.*, pp. 856–859, 2014.
- [11] M. Raca and P. Dillenbourg, "Classroom Social Signal Analysis," *J. Learn. Anal.*, vol. 1, no. 3, pp. 176–178, 2014.
- [12] C. Thureau and V. Hlavac, "Pose primitive based human action recognition in videos or still images," in *2008 IEEE Conference on Computer Vision and Pattern Recognition*, 2008, pp. 1–8.
- [13] Tao Zhao and R. Nevatia, "Tracking multiple humans in complex situations," *IEEE Trans. Pattern Anal. Mach. Intell.*, vol. 26, no. 9, pp. 1208–1221, Sep. 2004.
- [14] R. Gonzalez and R. Woods, "Digital image processing and computer vision," *Comput. Vision, Graph. Image Process.*, vol. 49, no. 1, p. 122, Jan. 1990.
- [15] M. Lyra, A. Ploussi, and A. Georgantzoglou, "MATLAB as a Tool in Nuclear Medicine Image Processing," *MATLAB - A Ubiquitous Tool Pract. Eng.*, no. October 2011, pp. 477–500, 2011.
- [16] G. Borenstein, *Making Things See: 3D Vision with Kinect, Processing, Arduino, and MakerBot*. 2012.
- [17] "Free How to Photoshop Tutorials, Videos & Lessons to learn Photoshop training | Photoshop Course." [Online]. Available: <http://www.we-r-here.com/ps/tutorials/>. [Accessed: 28-Nov-2017].
- [18] "Naushadsblog." [Online]. Available: <https://naushadsblog.wordpress.com/>. [Accessed: 28-Nov-2017].
- [19] N. Blanc, "CCD versus CMOS - has CCD imaging come to an end?," *Photogramm. Week 2001*, pp. 131–137, 2001.
- [20] "Wikimedia Commons." [Online]. Available: [https://commons.wikimedia.org/wiki/Main\\_Page](https://commons.wikimedia.org/wiki/Main_Page). [Accessed: 28-Nov-2017].
- [21] "Photography tips and tricks, Equipment, Photography News, Photography Books, Tutorial, and Lighting - OneSlidePhotography.com." [Online]. Available: <http://oneslidephotography.com/>. [Accessed: 28-Nov-2017].
- [22] W. K. Wong, P. N. Tan, C. K. Loo, and W. S. Lim, "An effective surveillance system using thermal camera," *2009 Int. Conf. Signal Acquis. Process. ICSAP 2009*, pp. 13–17, 2009.
- [23] "FLIR Systems | Thermal Imaging, Night Vision and Infrared Camera Systems." [Online]. Available: <http://www.flir.eu/home/>. [Accessed: 28-Nov-2017].
- [24] T. Sosnowski, G. Bieszczad, and H. Madura, "Image Processing in Thermal Cameras," Springer, Cham, 2018, pp. 35–57.
- [25] S. Hwang, J. Park, N. Kim, Y. Choi, and I. S. Kweon, "Multispectral pedestrian detection: Benchmark dataset and baseline," *Proc. IEEE Comput. Soc. Conf. Comput. Vis. Pattern Recognit.*, vol. 07–12–June, pp. 1037–1045, 2015.
- [26] L.-J. Ferrato and K. W. Forsythe, "Comparing Hyperspectral and Multispectral Imagery for Land Classification of the Lower Don River, Toronto," *J. Geogr. Geol.*, vol. 5, no. 1, pp. 92–107, 2013.
- [27] "What is the difference between multispectral and hyperspectral imagery? - eXtension." [Online]. Available: <http://articles.extension.org/pages/40073/what-is-the-difference-between-multispectral-and-hyperspectral-imagery>. [Accessed: 28-Nov-2017].
- [28] M. Aboras, H. Amasha, and I. Ibraheem, "Early detection of melanoma using multispectral imaging and artificial intelligence techniques Early detection of melanoma using multispectral imaging and artificial intelligence techniques," *Http://Www.Sciencepublishinggroup.Com*, vol. 3, no. November 2016, p. 29, 2015.
- [29] S. B. Gokturk, H. Yalcin, and C. Bamji, "A time-of-flight depth sensor - System description, issues and solutions," *IEEE Comput. Soc. Conf. Comput. Vis. Pattern Recognit. Work.*, vol. 2004–Janua, no. January, 2004.
- [30] P. Zanuttigh, C. D. Mutto, L. Minto, G. Marin, F. Dominio, and G. M. Cortelazzo, *Time-of-flight and*

*structured light depth cameras: Technology and applications*. 2016.

- [31] G. Calin and V. O. Roda, "Real-time disparity map extraction in a dual head stereo vision system," *Lat. Am. Appl. Res.*, vol. 37, no. 1, pp. 21–24, 2007.
- [32] Z. Cao, T. Simon, S.-E. Wei, and Y. Sheikh, "Realtime Multi-person 2D Pose Estimation Using Part Affinity Fields," in *2017 IEEE Conference on Computer Vision and Pattern Recognition (CVPR)*, 2017, pp. 1302–1310.
- [33] Jungong Han, Ling Shao, Dong Xu, and J. Shotton, "Enhanced Computer Vision With Microsoft Kinect Sensor: A Review," *IEEE Trans. Cybern.*, vol. 43, no. 5, pp. 1318–1334, Oct. 2013.
- [34] Z. Zhang, "Microsoft kinect sensor and its effect," *IEEE Multimed.*, vol. 19, no. 2, pp. 4–10, 2012.
- [35] "Kinect for Windows Sensor Components and Specifications." [Online]. Available: <https://msdn.microsoft.com/en-us/library/jj131033.aspx>. [Accessed: 02-Dec-2017].
- [36] "OpenPose - Realtime Multiperson 2D Keypoint Detection from Video | Flintbox." [Online]. Available: <https://cmu.flintbox.com/public/project/47343/>. [Accessed: 03-Dec-2017].
- [37] E. Insafutdinov *et al.*, "ArtTrack: Articulated Multi-person Tracking in the Wild," Dec. 2016.
- [38] E. Insafutdinov, L. Pishchulin, B. Andres, M. Andriluka, and B. Schiele, "DeeperCut: A Deeper, Stronger, and Faster Multi-Person Pose Estimation Model," May 2016.
- [39] "GitHub - CMU-Perceptual-Computing-Lab/openpose: OpenPose: Real-time multi-person keypoint detection library for body, face, and hands estimation." [Online]. Available: <https://github.com/CMU-Perceptual-Computing-Lab/openpose>. [Accessed: 17-May-2018].

## Analyzing the Potential Occurrence of Osteoporosis and its Correlation to Cardiovascular Disease Using Predictive Analytic

Kae Sawada  
Jet Propulsion Laboratory  
Pasadena, USA  
Kae.Sawada@jpl.nasa.gov

Zilong Ye  
Computer Science Department  
California State University, Los Angeles  
Los Angeles, USA  
zye5@calstatela.edu

Michael Wayne Clark  
Biology Department  
Pasadena City College  
Pasadena, USA  
mclark7@pasadena.edu

Nabil Alshurafa  
Medicine and of Computer Science Department  
Northwestern University  
Evanston, USA  
nabil@northwestern.edu

Mohammad Pourhomayoun  
Computer Science Department  
California State University, Los Angeles  
Los Angeles, USA  
mpourho@calstatela.edu

**Abstract**— In this paper, Big Data Processing was utilized to develop and validate a Predictive Analytics Model with the goal of determining the risk for an individual manifesting osteoporosis in later life. The analyzed dataset consists of the genomic information from over 2,500 individuals from all around the world. This model development leverages the novel genetic pleiotropic information, the two or more apparently unrelated phenotypes caused by a single gene. The dataset was examined for the mutations associated with osteoporosis and cardiovascular disease from the population genetics perspectives. The study also proposes the automatic histogram clustering as an effective and intuitive visualization method for high dimensional dataset. The data visualization and clustering results revealed a significant correlation between a person's regional background and the frequency of occurrence of the 35 single nucleotide polymorphisms (SNPs). These 35 SNPs are associated with osteoporosis and/or cardiovascular disease (CVD). Distinct SNP frequency of occurrence profiles were observed for specific geographic regions. Machine learning algorithms were then applied to predict the occurrence of 7 osteoporosis-related-SNPs based on the existing CVD-related-SNPs input as an experiment. The model's validity was confirmed through a separate experimental result, utilizing a set of data obtained through Affymetrix microarray mRNA expression signal values for the specific SNP(s) in individuals with and without osteoporosis. Furthermore, these results confirmed the genetic linkage between osteoporosis and Cardiovascular related parameters such as High Density Lipoprotein (HDL) and Systolic Blood Pressure (SBP). A useful Predictive Analytics Model for determining these genetic predispositions have been produced.

**Keywords**- osteoporosis; 1000 Genome Project; Machine Learning; Predictive Model; Genome Wide Association Study (GWAS); Data Visualization; Clustering; Classifiers; Supervised Learning.

### I. INTRODUCTION

Early prediction and detection of chronic diseases such as osteoporosis gives patients an opportunity to make lifestyle changes, which can ameliorate the severity of the disorder. It will also enable patients and doctors to prevent the medically adverse events associated with the chronic disease. Here, machine learning based classifiers were developed, trained, and tested to predict Osteoporosis at an early stage.

This study, originally presented in Biocomputational Systems and Biotechnologies, 2018. [1], investigates the occurrence of 7 selected osteoporosis-related Single-Nucleotide Polymorphism (SNP) [2], and their correlation to 28 CVD related SNPs [3]. In addition, the sample's geographic background, along with the physical proximities between each of the SNPs were examined.

Furthermore, this paper proposes a novel approach to automatic data-driven clustering of histogram presented data for verification and validation of disease related expression in different human populations. As explained in later sections, high dimensional datasets can be effectively and intuitively visualized by the algorithm generating the histogram clustering. This automated process could aid in understanding existing correlations among various types of large datasets.



### A. Osteoporosis and Space Exploration

Fractures, as a result of osteoporosis, will have a significant negative impact on an individual's health, quality of life, and work performance. Some modern occupations inevitably expose workers to a significantly increased risk of developing Osteoporosis. An obvious example is space flight. Within a few days of Zero Gravity (zero G), astronauts begin to lose both muscle and bone mass. There is also a zero G suppression effect on the immune system, as well as an increase in the aging process of particular cells. These effects occurred in all individuals who exposed themselves to a zero G environment, which can last for months after returning to Earth [4]. It is reasonable to assume that a predisposition to Osteoporosis might increase the occurrence of the condition. Having a reasonably reliable predictive model to reveal the predisposition for osteoporosis can allow us to apply preventive approaches or medical intervention to prevent the occurrence of the condition.

The 1000 Genome Project [5] sequenced over 7 TB of genetic data. The resulting datasets are collected from over 2,500 individuals from all over the world [6]. One effective way of utilizing such data is to understand the correlations between the observed variations in the DNA sequences in specific locations on the chromosome. Understanding the variations that influence specific diseases and conditions allows the prediction of risk for developing specific diseases/conditions in an individual's life time. Genome-Wide Association Studies (GWAS) have shown more than 107 genes and 129 SNPs to be associated with osteoporosis [7]. Such large genomic data sets allow for the study of complex disease states such as osteoporosis and cardiovascular disease. These pathologies involve not only multiple gene mutation interactions, but also nutritional and age-related components [8] [2]. Unfortunately, many of these gene mutations still maintain some level of phenotypic ambiguity [9] [10]. Modern Machine Learning analysis can potentially be employed to overcome the difficulty imposed by the multi-dimensional nature of the osteoporosis and CVD risk factors in analyzing the sequences. Such applications allow for early forecast of a patient-specific frequency of occurrence for a particular genetic disorder in later life. It allows for appropriate preventative measures to be followed.

The available sequenced genomes from the 1000 Genome Project enables direct examination of mutation variants with known relations to specified medical conditions such as osteoporosis. Some Machine Learning algorithms have been successfully utilized to decompose and understand the complex nature of genomic sequences in recent studies. Hidden Markov model utilization succeeded in identifying protein coding genes [11]. Support Vector Machine and Artificial Neural Network models identified certain genes' functional RNA encoding [12]. Random forest algorithms were able to predict the phenotypic effects of non-synonymous single nucleotide polymorphisms (SNPs) [13].

Several classification algorithms were utilized in this paper to predict genetic markers of osteoporosis, given genetic markers of CVD. The results of the predictor were used to analyze predisposition to osteoporosis in relation to demographic background. The first machine learning model

developed in this study confirms a genetic link between osteoporosis and CVD, which has been observed in patients. These results provide clues to understand genetic linkages in the context of population genomics. Particularly, when analyzing larger population data sets such as the 100,000 genomes in the UK, a result set obtained here will provide essential insights into future analysis.

### B. Mutations: SNPs

This paper analyzes 35 SNPs, that are commonly observed as genetic disease related mutations. It is a mutation of one base for another, which occurs in more than one percent of the general population [14]. 7 of these SNPs have direct indications in the expression of osteoporosis [9], while the other 28 SNPs have implications in both CVD and osteoporosis [4].

### C. Preceding Related Work

#### i. Osteoporosis-related-SNP selection

The 7 osteoporosis-related-SNPs were chosen based on the study led by Hsu et al. [2], published in 2010. The phenotypic association of these SNPs to osteoporosis was demonstrated by the GWAS study [7].

#### ii. Genetic Pleiotropy

Using False Discovery Rate (FDR) statistical methods, Reppe et al. [3] revealed a potential genetic link between Cardio-Vascular Disease (CVD) and Osteoporotic conditions. In this paper, the potential mutant gene interactions between the osteoporosis-related SNPs and CVD SNPs are analyzed with: big data processing and analytics, predictive analytics based on machine learning algorithms, data visualization, and clustering.

This paper is organized as follows: Section I is the introduction. In Section II, the methods and materials employed during the analysis and experimental developments are introduced. Included topics are the datasets and methods used, feature selections and dataset label, and evaluation methods. In Section III, the results and observations are discussed. Finally, Section IV will discuss conclusions.

## II. METHODS AND MATERIALS

This section describes the datasets and methods employed in this paper.

### A. Datasets

i. The first dataset includes the genotypes of 35 SNPs (See Table I and Table II) from the 1000 Genome Project collected from 2504 human subjects, both male and female, from 26 regions worldwide [5]. Given the 28 SNPs related to CVD, the objective was to predict occurrence of the other 7 Osteoporosis-related SNPs (Table I). In other words, feed corresponding features that represents SNPs listed in Table II, and predict the occurrence of SNPs listed in Table I. After preprocessing the data, a total number of 112 features (See

section II-B-ii) were extracted for the 28 SNPs (four possible pairs per SNPs), along with gender and region. The output label is a binary label indicating whether or not the individual has two or more of the high-risk Osteoporosis-related SNP(s) simultaneously. Note that this dataset does not contain the information indicating whether or not an individual developed osteoporosis.

The input dataset used in this study included 35 sets of comma-separated values (CSV) files, corresponding to each of the observed SNPs. Each set consists of 2504 samples, which consists of the following information:

- Sample ID with gender implication (Male/Female/Unknown).
- Genotype (forward strand).
- Population(s): 5 population categories, each divided into 4 - 7 subcategories.

Note: Gene locations of each SNP were appended to the given datasets to observe the proximities of each SNP to another

ii The second dataset is from Reppe et al's study mentioned in Section I-C-ii [16]. The samples of this dataset are collected from the 84 post-menopausal females between the ages of 50 to 86 years old in Lovisenberg Diakonale Hospital located in Sweden. There are two components to this dataset: (1) The result of Affymetrix Microarray analysis of the patients, the Affymetrix microarray signal values per sample, one ".CELL" file per patient.

(2). A set of biopsy results, sample ID (anonymous), age, gender, and the biopsy results of bone density scores, both T- and Z-scores, consisting of average neck, total hip, and average spine of each subject.

In this paper, all ".CELL" files from (1) were processed and interfaced with the library, pd.hg.u133.plus.2 [17], to obtain the gene symbol per an array cell. Then, it was interfaced with SNP identifier (e.g., #rsxxx..x, with x composing an integer) to acquire the existing SNP(s) data per each sample. In acquisition of SNP existence, the signal threshold value was determined the average score of all samples per column (per array cell). Such determination was made based on the preceding study, which defined signal thresholds in DNA microarray analysis [18]. Precise mapping among gene identifier, SNP identifier, and chromosomal location was achieved via ICSC Genome Browser [19].

The label per sample was acquired based on the data from (2). Samples with the T-scores of -2.5 or less in one or more of neck, hip, and spine are marked as osteoporotic. The threshold was determined, following the World Health Organization (WHO) international reference standard for osteoporosis diagnosis [20]. T-scores were used instead of Z-scores, based on the sample's age and the guidelines provided by WHO.

## B. Method Design

### i. Problem Definition

This study investigates the occurrence of 7 selected osteoporosis-related Single-Nucleotide Polymorphism (SNP) [2] and their correlation to 28 CVD related SNPs [3] (See I-C-i for osteoporosis-related SNPs and I-C-ii for CVD-related SNPs). In addition, the sample's geographic background, along with the physical proximities between each of the SNPs were examined. The CVD related SNPs were divided into six subcategories: High Density Lipids proteins cholesterol (HDL), Low Density Lips proteins cholesterol (LDL), Systolic Blood Pressure (SBP), Diastolic Blood Pressure (DBP), Type 1 Diabetes (T1D), and Triglycerides (TG). The table of osteoporosis-related SNPs (See Appendix A) describes the SNP identification number, normal (ancestral) base, high-risk (mutated) base, and the homozygous base pairs that are associated with a high risk of Bone Mineral Density (BMD) loss, and consequently the development of osteoporosis.

### ii. Features

As mentioned in the section II-B-i, 28 CVD-related SNPs, gender, and regional background of each sample were fed to the predictor to determine the presence of the 7 osteoporosis-related SNPs. The label for this predictor is a boolean value, whether the individual has one or more high-risk osteoporosis-related SNP(s).

### iii. Predictive Analytics Algorithms: Classifiers

Various predictor algorithms were applied and compared: KNN, Logistic Regression, Decision Tree, Naive Bayes, Adaboost, Random Forest, and Support Vector Machine. A systematic aggregation of these classifier results is future work, for example using ensemble learning algorithm.

### iv. Affymetrix Microarray

The second dataset introduced in II-A-ii-2) contains both the sample's genetic profile and BMD profile. However, it must be noted the dataset does not represent a wide scope of populations.

Running the mentioned predictor on this dataset will not only allow for validation of the proposed predictor design, but also provide an idea of how likely the mutant genes are to express their phenotype.

DNA microarray analysis allows for an evaluation of gene expressions profiles in a living individual. Such analysis provides data about the actual utilization of a specific gene by a specific organism. Thus, a SNP can be shown to be actively used by the individual increasing the likelihood of the SNP being related to the phenotype, the manifestation of a disease state.

Affymetrix microarray consists of a grid of oligonucleotide probes produced to have a known DNA sequence. The grid Microarray thus holds a specific SNP

mutation at a specific locus on the grid. Preparations of labelled mRNA (cDNA / cRNA) taken from the individual patients can then be exposed to the entire grid containing the variety of SNP mutations. Identification of a specific SNP in the patient is determined by the measured level of hybridization with the corresponding target grid position and the labelled cDNA/cRNA.

The corresponding SNP IDs were mapped through the affy ID and a gene symbol that are assigned to each cell, as well as the manual mappings of the target SNPs through a capability of the genome browser provided by University of California, Santa Cruz [19].

#### v. Prediction Accuracy Measure

In all cases of this study, the accuracy of the predictor was measured using 15 to 35-fold cross-validation [21].

#### vi. Phenotype Expression Measurement

The first dataset (see II-A-i), acquired from 1000 Genome Project lacked information on whether each individual developed osteoporosis or not. Therefore, another set of samples was sought to evaluate the geno-pheno-transfer rate as well as the validity of the predictor developed in this study. Two pieces of information had to be present in the data:

- 1) Each sample's SNP profiles
- 2) Presence of the condition, osteoporosis, in each sample

#### vii. Visualization

For most humans, visualizing the dataset with a dimension greater than 3 is difficult, if not impossible. This study visualizes the dataset of over 30 essential features by generating various histograms and applying a K-mean clustering algorithm implementation to cluster the resulting plots into groups. As demonstrated in the result section, the existing correlations in the dataset are clearly displayed through this visualization method. Such method of visualization can aid the observers in developing an intuitive understanding of the dataset, effectively mirroring the datasets' characteristics and patterns in them. In addition, this visualization method will aid in the automated identification of patterns in large datasets.

This section describes the result of the predictors ran against the two datasets, the data visualization and observed patterns.

#### A. Predictor results – Dataset from 1000 Genome Project

The predictions were performed by the classifiers in 32 different scenarios, each ran against an element of the powerset. For example, only the SNPs associated with T1D was input for the first iteration. TG-related SNPs were input for the second iteration, then DBP for the next iteration. Next, T1D-related and DBP-related SNPs are fed for another iteration, and so forth (see the 1<sup>st</sup> column of Table III for the combination of SNP inputs). As the Feature Length (the second column in Table III) increased, specific correlation stood out. The results obtained from various combinations of

SNP inputs clearly showed a strong correlation between the 7 osteoporosis-related SNPs and the HDL<sup>2</sup> SNPs. Similarly, another strong correlation was found between the 7 osteoporosis-related SNPs and SBP<sup>2</sup> SNPs. Our best classifier achieved the accuracy score of 0.7769.

TABLE I: SNP ASSOCIATED WITH OSTEOPOROSIS AND CVD

SNP (rs ID)	Ancestral allele	Mutated allele	Possible pair	High Risk Genotype	Phenotype (associated condition)
rs2278729	G	A	AA, GG, AG, GA	AA	Osteoporosis
rs12808199	A	G	AA, GG, AG, GA	GG	Osteoporosis
rs7227401	G	T	GG, TT, GT, TG	TT	Osteoporosis
rs494453	T	C	TT, CC, TC, CT	CC	Osteoporosis
rs12151790	G	A	AA, GG, AG, GA	AA	Osteoporosis
rs2062375	C	G	CC, GG, CG, GC	GG	Osteoporosis
rs17184557	T	A	TT, AA, TA, AT	AA	Osteoporosis

TABLE II: SNP ASSOCIATED WITH OSTEOPOROSIS AND CVD

SNP (rs ID)	Ancestral allele	Mutated allele	Possible pair	High Risk Genotype	Phenotype (associated condition)
rs4957742	A	G	AA, GG, AG, GA	GG	DBP
rs665556	C	T	TT, CC, TC, CT	TT	DBP
rs10779702	A	G	AA, GG, AG, GA	GG	HDL
rs12137389	T	C	TT, CC, TC, CT	CC	HDL
rs9309664	G	A	AA, GG, AG, GA	AA	HDL
rs7594560	T	C	TT, CC, TC, CT	CC	HDL
rs10953178	C	T	TT, CC, TC, CT	TT	HDL
rs980299	T	C	TT, CC, TC, CT	CC	HDL
rs10746070	T	C	TT, CC, TC, CT	CC	HDL
rs7175531	C	T	TT, CC, TC, CT	TT	HDL
rs3198697	C	T	TT, CC, TC, CT	TT	HDL
rs756632	C	T	TT, CC, TC, CT	TT	HDL
rs4820539	G	A	AA, GG, AG, GA	AA	HDL
rs6583337	G	A	AA, GG, AG, GA	AA	LDL
rs11809524	C	T	TT, CC, TC, CT	TT	SBP
rs11675051	G	A	AA, GG, AG, GA	AA	SBP
rs13005335	A	G	AA, GG, AG, GA	GG	SBP
rs12995369	A	G	AA, GG, AG, GA	GG	SBP
rs10464592	G	A	AA, GG, AG, GA	AA	SBP
rs1670346	A	G	AA, GG, AG, GA	GG	SBP
rs13272568	A	C	AA, CC, AC, CA	CC	SBP
rs600231	G	A	AA, GG, AG, GA	AA	SBP
rs258415	C	A	AA, CC, AC, CA	AA	SBP
rs11614913	C	T	TT, CC, TC, CT	TT	SBP
rs199529	C	A	AA, CC, AC, CA	AA	SBP
rs8090312	G	A	AA, GG, AG, GA	AA	T1D
rs2282930	G	A	AA, GG, AG, GA	AA	TG
rs10851498	T	C	TT, CC, TC, CT	CC	TG

### III. RESULTS

First dataset did not contain label information, indicating an individual's BMD score. The strength of this dataset was the abundance and diversity of SNP data across all available samples. Leveraging on the well-formatted and well-standardized dataset, the predictive analytics model was trained to predict the presence of osteoporosis-related SNPs. The prediction was a binary label - whether or not 2 or more homozygous osteoporosis-related SNPs were present in each

individual. The predictor predicts 'true/1' if an individual were to have 2 or more osteoporosis related SNPs simultaneously.

TABLE III: PREDICTION SCORES

name	Feature Length	Adaboost	Decision Tree	KNN	Logistic Regression	Naive Bayes	Random Forest
NONE	2	0.7331	0.7331	0.49	0.7331	0.7331	0.7331
T1D	6	0.7331	0.7331	0.6932	0.7331	0.7331	0.7331
TG	10	0.7331	0.7331	0.6773	0.7331	0.7331	0.7331
DBP	10	0.7331	0.7331	0.7052	0.7331	0.7331	0.7331
T1D_DBP	14	0.7331	0.7251	0.6892	0.7331	0.7331	0.7251
TG_T1D	14	0.7331	0.7291	0.6813	0.7331	0.7331	0.7211
TG_DBP	18	0.7331	0.6932	0.6693	0.7331	0.7331	0.6892
TG_T1D_DBP	22	0.7331	0.6853	0.6972	0.7331	0.7331	0.6773
HDL	45	0.7331	0.6096	0.6972	0.7331	0.7211	0.6972
SBP	46	0.757	0.6494	0.7052	0.753	0.7331	0.7171
HDL_T1D	49	0.7331	0.6255	0.7131	0.7331	0.7012	0.6972
T1D_SBP	50	0.757	0.6693	0.741	0.761	0.7331	0.7251
HDL_TG	53	0.7331	0.6016	0.6574	0.7331	0.7211	0.6693
HDL_DBP	53	0.7331	0.5498	0.6853	0.7331	0.7171	0.7052
TG_SBP	54	0.761	0.5777	0.6932	0.757	0.753	0.7171
SBP_DBP	54	0.7649	0.6892	0.7052	0.7689	0.7291	0.741
HDL_TG_T1D	57	0.7331	0.6295	0.6813	0.7331	0.7052	0.6773
HDL_T1D_DBP	57	0.7331	0.5976	0.7012	0.7331	0.7012	0.6773
TG_T1D_SBP	58	0.7649	0.6693	0.7211	0.7729	0.741	0.7291
T1D_SBP_DBP	58	0.761	0.7012	0.7052	0.7769	0.7251	0.745
HDL_TG_DBP	61	0.7331	0.6135	0.6653	0.7331	0.7211	0.7012
TG_SBP_DBP	62	0.757	0.6494	0.6892	0.749	0.7331	0.7171
HDL_TG_T1D_DBP	65	0.7331	0.5777	0.6972	0.7331	0.6932	0.6932
TG_T1D_SBP_DBP	66	0.7729	0.6175	0.7012	0.7729	0.7291	0.7291
HDL_SBP	89	0.757	0.6096	0.7092	0.757	0.6972	0.7131
HDL_T1D_SBP	93	0.7729	0.6614	0.7291	0.7729	0.6693	0.7729
HDL_TG_SBP	97	0.753	0.6096	0.6972	0.753	0.7012	0.7251
HDL_SBP_DBP	97	0.757	0.6653	0.6972	0.761	0.7012	0.7331
HDL_T1D_SBP_DBP	101	0.7649	0.6614	0.7291	0.7729	0.6813	0.7331
HDL_TG_T1D_SBP	101	0.7649	0.6733	0.7331	0.7689	0.6853	0.753
HDL_TG_SBP_DBP	105	0.761	0.6215	0.7012	0.757	0.7052	0.757
HDL_TG_T1D_SBP_DBP	109	0.7649	0.6693	0.7092	0.761	0.6813	0.7211

Table III shows the prediction results. The column headers point to the classifier algorithms used, and the row headers, "name", point to the varied combination of CVD-related SNP feature sets. First, classical algorithms, KNN, Naive Bayes, Decision Tree, and Logistic Regression were applied to the given dataset. Most algorithms yielded a better result as the number of features increased, while the results of Decision Tree worsened, demonstrating overfitting. Stacking (ensemble learning) algorithm was implemented with the 4 classic algorithms noted above, logistic regression, and Support Vector Machine as its base classifiers. The performance was measured with the 15-fold cross-validation. Predictor's performance improved with this classifier orchestration. The more robust and optimized ensemble learning methods, Adaboost and Random Forest implementations with decision stumps as their base classifiers were applied, and results were compared. A standard ANN implementation did not perform well with this dataset due to the small size of the dataset. The highest result of 0.7769 accuracy score was captured with Logistic Regression when HDL, TG, SBP, and DBP subcategories of the CVD-SNPs were used to train and test the model. For more information on parameter values applied, please contact the authors.

The prediction results demonstrate the relationships between CVD-related SNPs and osteoporosis disease. These results show calculable relationships between CVD and Osteoporosis. The Predictor could now be used for early stage warning for future disorders. This implies that the CVD

patients may have a higher chance of developing osteoporosis. It also indicates the possibility of predicting Osteoporosis at an early stage based on CVD-related factors such as Cholesterol, Blood Pressure, and Triglycerides levels.

### B. Predictor results – Affy dataset

The performances of the predictive model for 3 different scenarios are listed in the following. We calculated ROC AUC (Receiver Operating Characteristic – Area Under Curve) to evaluate the performance of the system. Unlike the previous experiment, this experiment setting did not distinguish high-risk heterozygous pair vs. high-risk homozygous pair. Here are the results for 3 different

#### Scenarios:

scenario 1 - Osteoporosis SNPs only – AUC = 0.7285

scenario 2 - CVD SNPs only – AUC = 0.7569

scenario 3 - Both CVD and Osteo SNPs - AUC = 0.8571

The predictor strategy developed here has been confirmed with the available disease related database of Reppe et al. The predictor was shown to be correct in the majority of the patients. These results also confirm the correlation of osteoporosis SNPs with CVD SNPs reported in the previous section.

In most cases, the chance of a mutant genotype expressing its aberrant phenotype is much less than 100%. As a well-studied example, the two mutations related to Breast Cancer, BRCA – 1 and BRAC – 2, show such occurrence. The chances these two mutations expressing their phenotypes by the time a woman is 70 years old are 55% for BRCA-1, and 45% for BRCA-2, according to a report by the Susan G. Komen Foundation [22].

The accuracy of the predictor developed with this paper of close to 70% demonstrated an effective prediction. Such a score would thus be reasonably effective to caution individuals about having a higher risk of BMD loss. With such knowledge, individuals can take the necessary preventative measures to prevent the development of undesirable conditions and disease, starting at an early stage of their lives.

### C. Statistical Analytics and Data Visualization

To effectively visualize the existing correlations among this moderately high dimensional dataset, various histograms were drawn, using python Matplotlib library [23]. The histograms shown in the following figures demonstrate the number of occurrences of each SNP that corresponds to the indices on the x-axis. For the numerical values of all visualized data, please contact the authors.

The histograms drawn based on gender, male and female, did not display significant variation in their osteoporosis-related SNP profiles. However, distinct patterns were observed in the histograms drawn based on various geographical regions. Figure 1 demonstrates two completely different SNP profiles that come from two

regions that are located far apart. Figure 2 demonstrates two similar SNP profiles that come from two regions that are closely located.

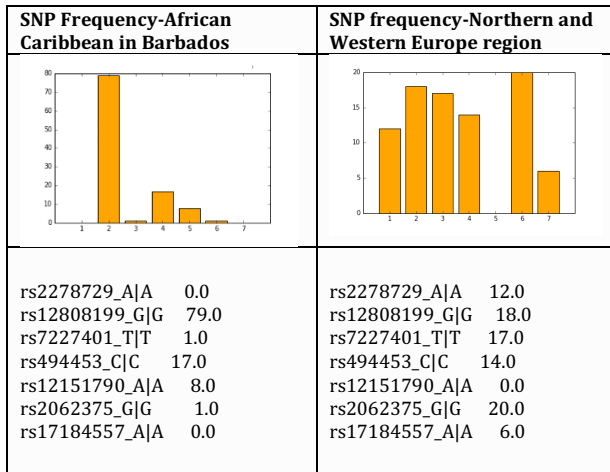

Figure 1: Varied SNP Profiles

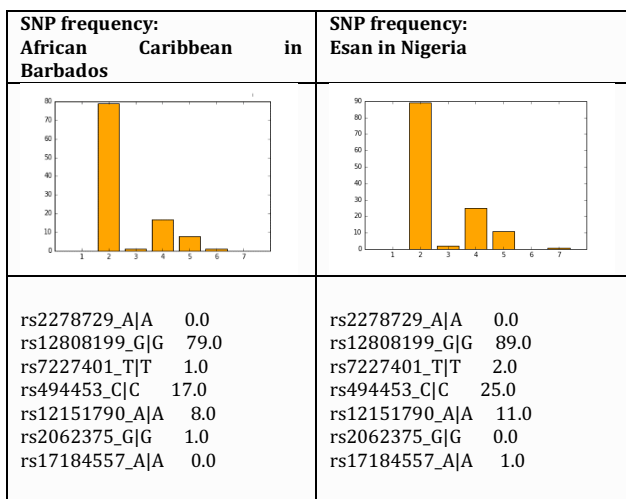

Figure 2: Similar SNP Profiles

To further investigate the histogram patterns, all histograms were manually grouped based on profile similarity. The results of the division are five larger categories and twelve subcategories.

The aim of this section is to group the histograms into several categories solely based on the shape of the plots, thus SNP profile. To eliminate any bias in the histogram grouping, we removed all labels from the plots. The results demonstrated that the grouping solely based on plot shapes perfectly matched the grouping based on the geographical regions. The groups also demonstrated that regional backgrounds known to have higher rates of Osteoporosis also have more SNPs present (see Fig 3). Thus, two important conclusions can be drawn here:

1) The 7 SNP profiles are dependent on an individual's regional background.

2) The more of these 7 SNPs the individuals have, the more they are predisposed to developing osteoporosis.

1. Regional Divide

The grouping results demonstrated the divides in people's SNP characteristics. This result is consistent with the idea that a person's genetic construct is dependent on the region, in which his/her genes have evolved.

2. Number of SNPs in an Individual

It has been statistically shown that Europeans tend to develop osteoporosis more frequently and they are more prone to bone mass density (BMD) loss, thus leading to major bone fractures, compared to Africans. It has also been shown that compared to Swedish Europeans, East Asians have a lesser chance of developing osteoporosis, particularly in women [4]. Even though we concluded that there were no significant differences in osteoporosis-related SNP distributions among the two genders, the differences in hormonal systems and the pregnancy events make females more vulnerable to a development of osteoporosis [24]. The results obtained here are consistent with such claims.

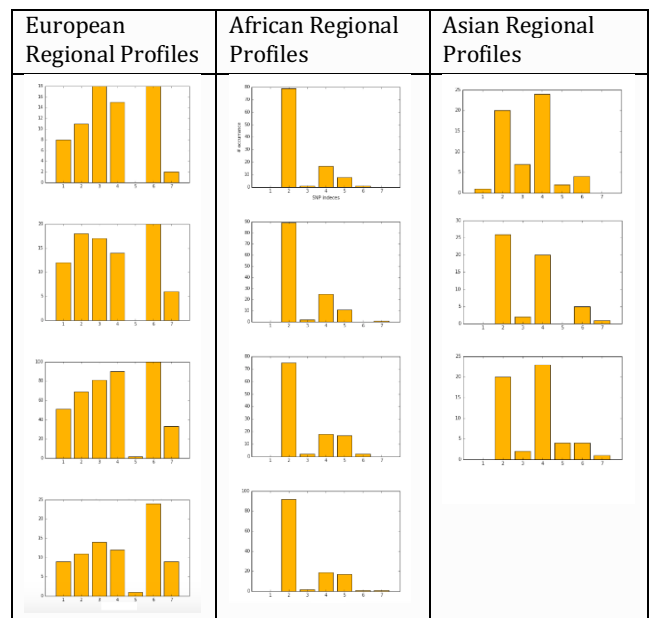

Figure 3: SNP Regional SNP Profile Comparison

A high frequency of Osteoporosis-related SNPs is observed in Europe while a low frequency of them are observed in Africa region. European Regional Profiles: [British in England and Scotland (1st graph, top to bottom), Northern and Western European Ancestry (2nd graph), Europa (3rd graph), Iberian Population in Spain (4th graph)], African Regional Profiles [African Caribbean in Barbados (1st graph), Esan in Nigeria (2nd graph), Mende in Sierra Leone (3rd graph), Yoruba in Ibadan Nigeria (4th graph)], Asian Regional Profiles: [Kinh in Ho Chi Minh City – Vietnam (1st graph), Han Chinese in Beijing – China (2nd graph), Southern Han Chinese (3rd graph)]



As shown in Figure 3, the 7 osteoporosis-related SNPs are found much more frequently in European region, compared to Africa or Asia. This observation is consistent with the fact that European women tend to have a higher incident of osteoporosis and hip fractures. Individuals of European heritage have a much greater possibility of the presence of osteoporotic mutations than African individuals [25].

Such a result leads to the following question: Do these regional groupings change with the inclusion of another SNP related to osteoporosis? What would happen to the histogram profile if we added more SNPs that are associated with osteoporosis/BMD to the histogram plots?

According to the GWAS Catalogue, there are over 60 to 107 identified SNPs that have correlations to osteoporosis/BMD loss, in addition to the 7 osteoporosis-related SNPs that are strongly associated by GWAS [7].

**F. Plot Grouping (8 SNPs) to Test Correlation**

In this section, another SNP (randomly chosen from the osteoporosis-related SNPs) was added, histograms were drawn, and grouping was done in the same way as on the original 7 SNP regional profiling. The 8th SNP, rs2569031, was the identified high-risk base pair added here. The overview of the grouping results is shown in Figure 4.

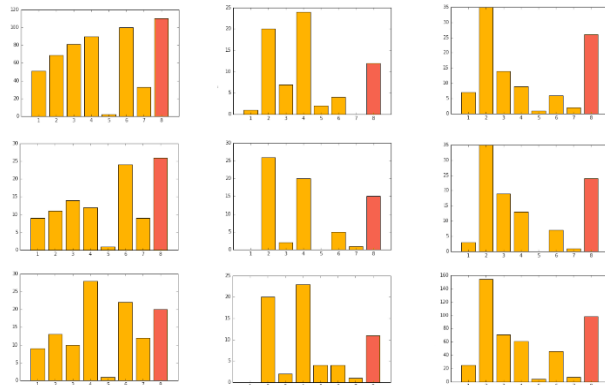

Figure 4: Randomly Chosen Additional SNP Profile Injection

The new SNP profile clustering (Figure 4) clearly follows the trend derived from the 7 SNPs grouping. The 8th SNP was found frequently in the leftmost group (European region), whereas it was found less frequently in the rightmost group (African region).

The identical procedures were applied to the CVD-related SNPs. The results of the clustering confirmed high correlations between region and the SNP profile, particularly for SBP and HDL related SNPs (See Figure 5).

Figure 6 shows the comparison with the HDL SNP profiles of people of Europe and Africa. It clearly reaffirms to the points made above.

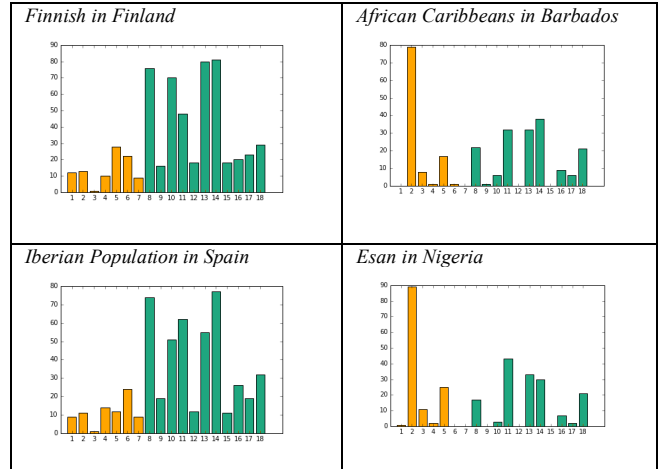

Figure 5: SNP Profiles - SBP European Regions vs. African Regions

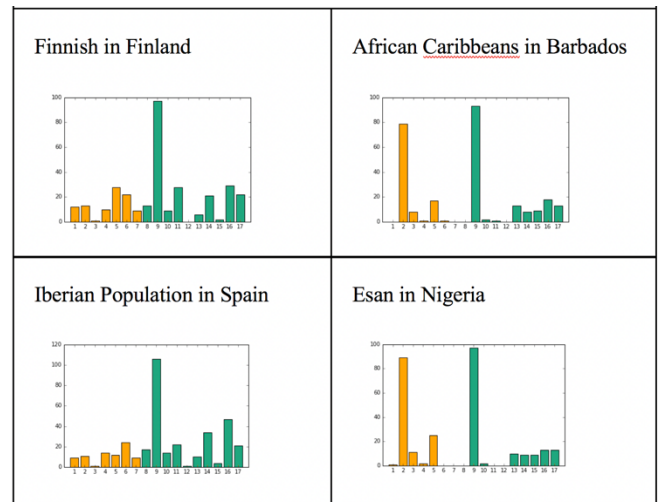

Figure 6: SNP Profiles - HDL

**G. Clustering Automation**

To verify the manual regional grouping of the histogram profiles, an automated clustering process was developed, utilizing KMeans clustering algorithm [26].

KMeans clustering is accomplished by minimizing the sum of the distances between the chosen centroids and each data point within the group, to which each centroid belongs to (See Equation 1). This algorithm was determined to be suitable for this experiment for two reasons: 1) The dimensionality of the dataset is not extremely large. 2) The number of clusters that the algorithm was approximated during the manual grouping.

$$t = \sum_{k=1}^K \sum_{i \in C_k} \|x_i - \mu_k\|. \tag{1}$$



Figure 7 shows a sample result of this automated clustering.

Sample groups obtained in automated histogram clustering result. The results verify the regional divide of osteoporosis- and CVD-related SNP profiles. Left Most Column: [Europa, Iberian Population in Spain, Utah Residents (CEPH) with Northern and Western European Ancestry, British in England and Scotland, Finnish in Finland, Toscani in Italia], Middle Column: [Bengali from Bangladesh, Sri Lankan Tamil from the UK, Indian Telugu from the UK, Gujarati Indian from Houston, Texas, Punjabi from Lahore, Pakistan], Right Most Column: [Peruvians from Lima, Peru, Puerto Ricans from Puerto Rico, Mexican Ancestry from Los Angeles USA, Colombians from Medellin, Colombia]. The result of clustering confirms the regional divide of the histogram profiles.

To demonstrate the value of this clustering automation, the final number of clusters to be formed by the algorithm was varied. As shown in Figure 8, when the number of clusters is set to 12, the algorithm groups South Asian SNP profiles and American SNP profiles into two separate groups, perfectly distinguishing the two separate regions. However, when the number of clusters is set to 11, the South Asian profiles and American profiles are bundled up into a single group. Such a result shows the possibility of further the effects of osteoporosis on humans are even important to NASA. Their studies have found that within a few days at low gravity, astronauts show significant bone density loss. NASA and other space agencies are actively investigating the exact effects of the outer space specific environments on human biological systems. Understanding such effects on skeletal system, cardiovascular system, nervous system, reproductive system, and our genome is crucial when attempting to adapt to an unknown environment. Being able to use an astronaut's genetic predisposition to predict how that individual's body might respond to zero or low Gravity could only improve the outcome of commercial space flight and the expansion of humanity into space. The Chinese state that they will have a manned Moon base by the end of 2019. What will be the effect of one sixth Earth gravity of those individuals? The data has yet to be collected. Such a result shows the possibility of further dissection of the regionalism seen here by the automated process. Automation of the histogram profiles also allowed increased number of SNPs to be analyzed all at once.

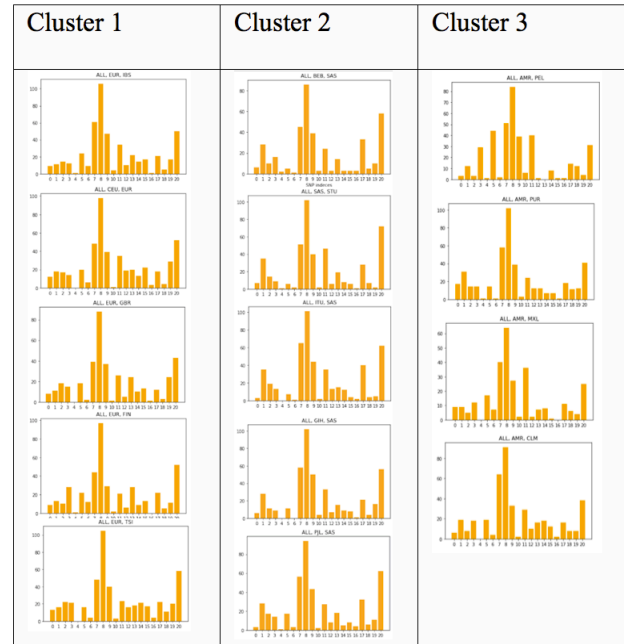

Figure 7: A Sample Histograms Demonstrating Regional Divides

#### H. The Number of SNPs per Individual

An unexpected finding in this study was that there was no individual who had all of the 7 osteoporosis-related SNPs simultaneously. The maximum number of SNPs that occurred in one individual was 4 out of the 7 SNPs, and 5 out of the 8 osteoporosis-related SNPs. Although four of the 7 osteoporosis-related SNPs are more likely to be found in osteoporotic females, and some are more likely to be found in males [2], all 7 SNPs were seen in at least 26 counts among males, 35 counts among females. Such cases, in which individuals have all 7 mutations were perhaps eliminated over the course of evolution.

Potential of BMD loss in individuals. Such a technique can provide an effective aid to medical professionals in the diagnosis of future disease expression based on a person's genetic profiles, biological signs, and family histories. An appropriate set of treatments/ remedies can thus be generated, utilizing the predictor.

#### IV. CONCLUSIONS AND DISCUSSION

The mutation frequency profiles related to Osteoporosis displayed geographical regionalism. These data are consistent with the occurrence of the clinical observation for the development of osteoporosis. This observation lead to the development of a predictive model to measure the

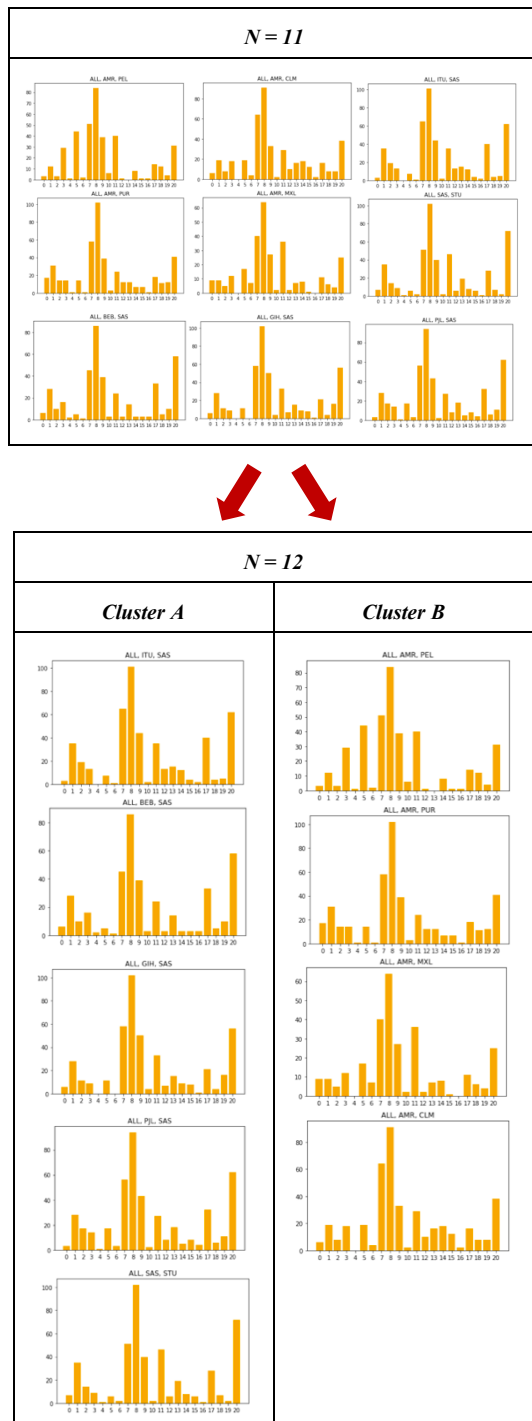

Figure 8: A Sample Auto-Clustering Result

Within the past few years, over 1200 ancient genome have been sequenced [27]. If these osteoporosis SNPs display regionalities, it would be of interest to determine how far back in human history these SNPs might go. With the publication of many ancient human genomes, we now have the opportunity to examine the fuller history of mutations

among humans. We have taken a brief look at the Neanderthals genome [28] and found the presence of these SNPs. Further analysis would allow us to construct a phylogenetic tree of osteoporosis mutations. Closer look into our past may help us better educated look into the future.

*Summary of the Results:*

i. Our results demonstrated that there was a high correlation between a person’s regional background and the occurrence of the selected 35 SNPs associated with osteoporosis and/or CVD. This finding conformed to the claims in some of the preceding Osteoporosis population/demographic studies: highest fracture rates are found in white women of European descent. African Americans tend to have higher BMD [25]. Swedish elderly women tend to suffer from bone fracture more often than Asian elderly women [5].

ii. In all 2504 individuals examined, the minimum and maximum occurrence of the selected 7 Osteoporosis-related SNPs in an individual was between 0 and 4 respectively, and 1 and 16 in all 35 SNPs. No individual with all 7 Osteoporosis-related SNPs was present among the 2504 individuals.

iii. Our results demonstrated that there were distinct correlations between the 7 Osteoporosis-related SNPs and CVD related SNPs (8 SNPs). This finding strongly indicated the CVD patients might have a higher chance of developing Osteoporosis. Such correlation data can be utilized to predict Osteoporosis at an early stage based on CVD-related factors such as Cholesterol level, Blood Pressure, and Triglycerides level.

iv. Our algorithm demonstrated that the set of CVD-/Osteoporosis-related SNPs from Reppe et al's dataset can be used to predict a person's likelihood of developing osteoporosis on their own without factoring in any non-genetic factors such as food intake, exercise habits, and other drug intake and medication.

v. We have shown that Histogram analysis and auto-clustering of such histograms is a highly effective visualization technique, capturing existing correlations among a high dimensional dataset.

The United Kingdom is now half way through its 100,000 Genome Project. The goal of obtaining this massive human genome dataset was to determine genetic predisposition to genetic related diseases such as cancer, CVD and osteoporosis. We hope that the automated systems developed here will be of significant assistance in achieving these goals.

## REFERENCES

- [1] K. Sawada, M. W. Clark, Z. Ye, N. Alshurafa, and M. Pourhomayoun, "Predictive Analytics to Determine the Potential Occurrence of Genetic Disease and their Correlation: Osteoporosis and Cardiovascular Disease," the Proceeding of The Tenth International Conference on Bioinformatics, Biocomputational Systems and Biotechnologies, 2018.
- [2] H. Yi-Hsiang, et al. "An integration of genome-wide association study and gene expression profiling to prioritize the discovery of novel susceptibility Loci for osteoporosis-related traits." *PLoS genetics* 6, no. 6, e1000977, 2010.
- [3] S. Reppe, Y. Wang, W.K. Thompson, L. K. McEvoy, A. J. Schork, V. Zuber et al. GEFOS Consortium. "Genetic sharing with cardiovascular disease risk factors and diabetes reveals novel bone mineral density loci." *PloS one* 10, no. 12, e0144531, 2015.
- [4] E. Roberge. "The Gravity of It All: From osteoporosis to immunosuppression, exploring disease in a microgravity environment holds promise for better treatments on Earth." *IEEE pulse* 5, 2014.
- [5] IGSR and the 1000 Genomes Project. [Online] Available at: <http://www.internationalgenome.org/> [retrieved: Nov. 2018].
- [6] Which populations are part of your study? [Online] Available at: <http://www.internationalgenome.org/faq/which-populations-are-part-your-study> [retrieved: Nov. 2018].
- [7] GWAS Catalog. [Online] Available at: <https://www.ebi.ac.uk/gwas/> [retrieved: Nov. 2018].
- [8] O. Hitomi, S. Sasaki, H. Horiguchi, E. Oguma, K. Miyamoto, Y. Hosoi, M. K. Kim, and F. Kayama. "Dietary patterns associated with bone mineral density in premenopausal Japanese farmwomen--." *The American journal of clinical nutrition* 83, no. 5, pp. 1185-1192, 2006.
- [9] D. Karasik, H. Yi-Hsiang, Y. Zhou, L. A. Cupples, D. P. Kiel, and S. Demissie. "Genome-wide pleiotropy of osteoporosis-related phenotypes: the Framingham study." *Journal of Bone and Mineral Research* 25, no. 7, pp. 1555-1563, 2010.
- [10] L. Langsetmo, et al. "Using the same bone density reference database for men and women provides a simpler estimation of fracture risk." *Journal of Bone and Mineral Research*, no.10, pp. 2108-2114, 2010.
- [11] I. M. Meyer, and R. Durbin. "Gene structure conservation aids similarity based gene prediction." *Nucleic acids research* 32, no. 2, pp. 776-783, 2004.
- [12] R. J. Carter I. Dubchak, and S. R. Holbrook. "A computational approach to identify genes for functional RNAs in genomic sequences." *Nucleic acids research* 29, no. 19, pp. 3928-3938, 2001.
- [13] T. Chen, M. Y. Kao, M. Tepel, J. Rush, and G. M. Church. "A dynamic programming approach to de novo peptide sequencing via tandem mass spectrometry." *Journal of Computational Biology* 8, no. 3, pp. 325-337, 2001.
- [14] U.S. National Library of Medicine | What are Single Nucleotide Polymorphisms (SNPs)? [Online] Available at: [https://ghr.nlm.nih.gov/primer/genomicresearch/snp\\_](https://ghr.nlm.nih.gov/primer/genomicresearch/snp_) [retrieved: Nov. 2018].
- [15] Ensemble Genome Browser [Online] Available at: <https://uswest.ensembl.org/index.html> [retrieved: Nov. 2018].
- [16] E-MEXP-1618 - Transcription profiling of bone biopsies from postmenopausal females identifies 8 genes highly associated with bone mineral density [Online] Available at: <https://www.ebi.ac.uk/arrayexpress/experiments/E-MEXP-1618/files/> [retrieved: Nov. 2018].
- [17] Bioconductor 3.6 Annotation package, pd.hg.u133.plus.2 [Online] Available at: <http://bioconductor.org/packages/release/data/annotation/html/pd.hg.u133.plus.2.html> [retrieved: Nov. 2018].
- [18] M. Bilban, L. K. Buehler, S. Head, G. Desoye, and V. Quaranta. "Defining signal thresholds in DNA microarrays: exemplary application for invasive cancer." *BMC genomics* 3, no. 1, 19, 2002. 2015 ISCD Official Positions – Adult [Online] Available at: <https://www.iscd.org/official-positions/2015-iscd-official-positions-adult/> [retrieved: Nov. 2018].
- [19] UCSC Genome Browser on Human Dec. 2013 (GRCh38/hg38) Assembly [Online] Available at: <https://genome.ucsc.edu/> [retrieved: Nov. 2018].
- [20] World Health Organization – WHO Criteria for Diagnosis of Osteoporosis [Online] Available at: <http://www.4bonehealth.org/education/world-health-organization-criteria-diagnosis-osteoporosis/> [retrieved: Nov. 2018]
- [21] The documentation for *sklearn.model\_selection.cross\_val\_score* [Online] Available at: [http://scikit-learn.org/stable/modules/generated/sklearn.model\\_selection.cross\\_val\\_score.html](http://scikit-learn.org/stable/modules/generated/sklearn.model_selection.cross_val_score.html) [retrieved: Jan. 2018].
- [22] Suzan G. Koman Foundation [Online] Available at: <https://ww5.komen.org/> [retrieved: Nov. 2018]
- [23] The Matplotlib API [Online] Available at: <https://matplotlib.org/2.0.2/api/index.html> [retrieved: Nov. 2018].
- [24] P. Salari, and M. Abdollahi. "The influence of pregnancy and lactation on maternal bone health: a systematic review." *Journal of family & reproductive health* 8, no. 4, p. 135, 2014.
- [25] N. Hae-Sung, S. S. Kweon, J. S. Choi, J. M. Zmuda, P. C. Leung, L. Y. Lui, et al. "Racial/ethnic differences in bone mineral density among older women." *Journal of bone and mineral metabolism* 31, 2013.
- [26] *sklearn.cluster.KMeans* [Online] Available at: <https://scikit-learn.org/stable/modules/generated/sklearn.cluster.KMeans.html> [retrieved: Nov. 2018].
- [27] Harvard Medical School. "Ancient-DNA researchers surpass the 1,000-genome milestone." *ScienceDaily*. *ScienceDaily*, 21 February 2018. [online] Available at: [www.sciencedaily.com/releases/2018/02/180221131848.htm](http://www.sciencedaily.com/releases/2018/02/180221131848.htm) [retrieved: Nov. 2018].
- [28] Ensemble Neandertal Genome browser [online] Available at: [http://neandertal.ensemblgenomes.org/Homo\\_sapiens/Location/View?t=13:31787617-31871809](http://neandertal.ensemblgenomes.org/Homo_sapiens/Location/View?t=13:31787617-31871809) [retrieved: Nov. 2018].
- [29] K. Sawada, M. W. Clark, N. Alshurafa, and M. Pourhomayoun, "Analyzing the Mutation Frequencies and Correlation of Genetic Diseases in Worldwide Populations Using Big Data Processing, Clustering, and Predictive Analytics," *International Conference on Computational Science and Computational Intelligence*, pp. 1459 – 1464, 2017.
- [30] Epidemiology by International Osteoporosis Foundation [Online] Available at: <https://www.iofbonehealth.org> [retrieved: Nov. 2018].
- [31] J. B. Richards, H. F. Zheng, and T. D. Spector, "Genetics of osteoporosis from genome-wide association studies: advances and challenges," *Nature Reviews Genetics*, 2012.
- [32] US Department of Health and Human Services. "Bone health and osteoporosis: a report of the Surgeon General." Rockville, MD: US Department of Health and Human Services, Office of the Surgeon General 87, 2004.
- [33] J. Greenbaum, K. Wu, L. Zhang, H. Shen, J. Zhang, and H. W. Deng. "Increased detection of genetic loci associated with risk predictors of osteoporotic fracture using a pleiotropic cFDR method." *Bone* 99, pp. 62-68, 2017.
- [34] D. Karasik, and M. Cohen-Zinder. "Osteoporosis genetics: year 2011 in review." *BoneKey reports* 1, no. 8, 2012.
- [35] L. Qin, Y. Liu, et al. "Computational characterization of osteoporosis associated SNPs and genes identified by genome-wide association studies." *PloS one* 11, no. 3, e0150070, 2016.

## The Sustainable Growth Use of Renewable Energy Based on Spatial Energy Planning: Lithuanian Case

Valentinas Klevas and Audrone Kleviene

Laboratory for Renewable Energy and Energy Efficiency  
Lithuanian Energy Institute  
Kaunas, Lithuania

[Valentinas.Klevas@lei.lt](mailto:Valentinas.Klevas@lei.lt); [Audrone.Kleviene@lei.lt](mailto:Audrone.Kleviene@lei.lt)

**Abstract** — The article summarizes the results of research, identifying the main challenges to increasing sustainable use of Renewable Energy Sources (RES)-technologies. The main obstacle to the widespread use of RES is the failure to address the key issue – to measure the benefits to the society - reduction of pollution, energy supply for the future generations, huge and never-ending potential of energy resources, such as solar and wind energy, when introducing RES-technologies. There are also controversial phenomena, especially in the heat sector. Unreasonably huge role is assigned to biomass in usage projections of RES. Huge disproportion of used RES technologies is a serious challenge to the sustainable development of energy and threat to forests and their ecosystems. The aim of the research is to apply the methodological approach enabling assessment of external benefit of the use of renewable energy sources, which is usually not assessed for individual projects. External conditions and current infrastructure for RES technologies are different, thus spatial planning, such as urban energy development plans, is the most appropriate tool for the external benefit assessment. Regional programs may be appropriate tools for reducing renewable energy adaptation costs, increasing competitiveness in the market, promoting social development and should be the main form for combination of different types of RES and consolidation of investment funds. The sustainable growth of renewable energy is based on the formulated methodology, which enables to achieve maximal benefit with minimal support for beneficiaries as well as for the state. Modified levelized cost of energy method enables analysis of economic benefit for the selected project investor, as well as relates the achieved results to macroeconomic indicators using external parameters. Combination of different types of RES may create large external effect and make a significant impact not only on individual consumer of RES, but on the whole society as well. The main output of the research is background for the support policy to encourage investors, which may be created on the basis of external benefits.

*Keywords-renewable energy; sustainable development; evaluation principles; external benefits.*

### I. INTRODUCTION

This publication is based on an article published in the IARIA conference proceedings “The Sustainable Growth Use of Renewable Energy Based on Spatial Energy Planning” [1]. The findings of this article are the result of

many projects carried out by the authors. Like in other EU countries, so in Lithuania economic research of Renewable Energy Sources (further in the text – RES) has intensified in the recent years through implementation of European Union directives, with particular emphasis on the role of a territorial aspect (cities, districts). Incentives for wider use of RES are declared both in the European Union and in Lithuanian laws. Adoption of the Directive 2009/28/EC “On the promotion of the use of energy from renewable sources” [2] required the development of a National Renewable Energy Action Plan for 2010-2020 and many other documents at the local level. This indicates that the development of RES takes an increasingly more significant role in the energy policy of all member states, including the Republic of Lithuania.

The main obstacle to the widespread use of RES is the failure to address the key issue – to measure the benefits to the society (reduction of pollution, energy supply for the future generations, huge and never-ending potential of energy resources, such as solar and wind energy), when introducing RES-technologies and, on the basis of these benefits, to encourage investors. Therefore, when formally calculating, RES-technologies are not sufficiently competitive, compared to fossil-fuel technologies. This work deals specifically with the problem of the impact of RES-technologies both positive and negative. The impact analysis of RES-technologies on social welfare (on job creation) and on health (on the basis of environmental impact) has allowed the formation of a targeted, reliable methodology compatible with the status of existing statistical information. On the basis of it, algorithms calculating the impact for individual types of RES are formed [3].

Given that in the newly developed Energy Strategy high hopes to use RES-technologies are linked to the extremely low used energy sources, such as solar, wind and geothermal energy, significant efforts are needed to organize the accounting and statistics of decentralized RES-producers. Apart from this important condition, it is difficult to expect the proper process management of mastering RES. The analysis of positive and negative impact of RES usage in the research of Lithuania and other countries has shown that major part of positive impact of the RES development is related to reducing Green House Gas (further in the text – GHG) and other pollutant emissions, job creation and rural



development. The positive effects of biofuels, biogas and biofuel manufacturing sectors are mainly reflected on the increase of employment level in the regions, the reduction of heat prices and lower emissions of some fossil fuels, which in the long run could affect the decline in the incidence of certain diseases. The development of biogas production and use also plays an important role in solving the problem of organic waste management. The main positive effects of solar and wind energy technologies are the reduction of GHG emissions compared to the use of fossil fuels and biofuels as well as the creation of temporary jobs in Lithuania by installing new solar power plants or wind farms. Developing the manufacturing technology industry in Lithuania also has a positive effect on the creation of additional permanent jobs.

Section II describes the concept of external utility of implementation of RES technologies. Evaluation of such utility may show the advantages, which are underestimated in the investment decisions. Section III presents a solution of the identified scientific problem; it is based on a system of territorial urban planning. In Section IV is presented a description of how RES programs can consolidate related urban development programs. This may serve to formation of financing assumptions and sources for their implementation. The methodology, which is based on spatial planning, identifies certain aspects that usually are not covered by routine investment evaluation techniques, namely, the existing problems in cities: high atmospheric pollution, unemployment, etc., may determine the validity conditions that allow interpolating results to assess technology for spatial energy planning for solving problems mentioned above. Long distances to centralized electricity and heat networks are defined by geolocation factors and may determine financial acceptability of small decentralized renewable energy technologies due to their technical benefits.

## II. CONCEPT OF EXTERNAL BENEFIT OF RES TECHNOLOGIES AND CHALLENGES TO SUSTAINABILITY

In recent years, consumption of fossil fuel and mitigation of climate change have become major challenges for governments all over the world. To engage these challenges, many countries are pursuing research, development, and demonstration of RES [4]. In the past few years, usage of RES rapidly increased all over the world. RES have become important alternative energy sources to realize energy diversification. During the last few years, political support for renewable energies has been growing continuously both at the national and international level [5][6].

Increase of social and political pressure for fast development in clean energy, and financial crisis, which required adequate government measures to stimulate the economy. The industry of renewables could be important to generate employment and stimulate growth [7]. Investment in RES may bring considerable profits, so more and more enterprises will be involved in this field. The increased use of RES in the heat market can significantly alleviate the negative effects of high energy costs on the national

economy. Successful commercialization of indigenous, renewable energy resources is expected to promote regional economic development and employment, enable to increase national energy security and to reduce a substantial portion of the increasing trade deficit necessity to import fossil fuels [8].

The use of renewable energy in rural as well as urban areas became the significant development thus adding to mitigation of climate change [9][10], reducing differences between rural and urban dwelling options [11], bringing new RES options for diversifying energy supply [12][13][14]. The role of local governance for energy and urban development appears highly important here [15].

However, there are also controversial phenomena, especially in the heat sector, where huge disproportion of used RES has appeared. Unreasonably huge role is assigned to biomass in usage projections of RES. Biomass is an energy resource that is the result of economic activity and depends on continuity of economic activity. Meanwhile, the use of an inexhaustible solar and geothermal energy potential is absolutely insufficient.

At present renewable energy sources (RES) are treated as an integrated whole, and all the advantages and disadvantages are classified as generalized, but at the same time separated from specific conditions and the infrastructure that is possible to use.

Therefore, one of the most difficult issues to be solved is that the utilization rate of RES in Lithuania (and maybe in other countries) is one-sided, focused on the use mainly of biomass for many reasons, which are not adequately investigated and identified. Meanwhile, other types of RES, such as solar, wind or geothermal energy, are scarcely used.

Figure 1 shows the state of the use of RES technologies in Lithuania.

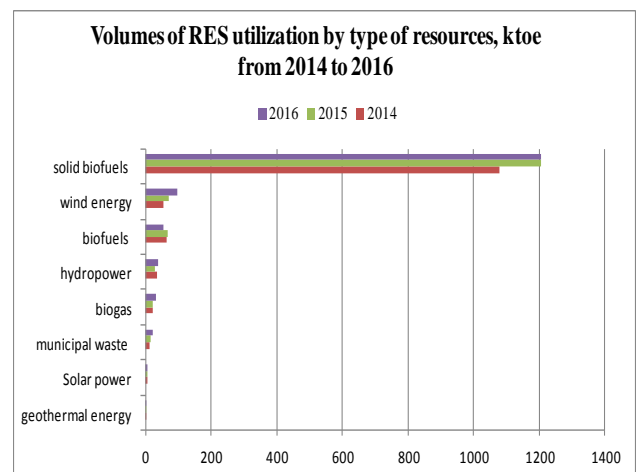

Figure 1. Disproportions of the use of RES-technologies in Lithuania.

The data of Figure 2 show the percentage of RES technologies utilization by regions in the heat sector. Here is dominated biofuels, whose combustion somehow treats as neutral in terms of CO<sub>2</sub> emissions. This is a serious

challenge to the sustainable development of energy. There is also danger to forests and their ecosystems.

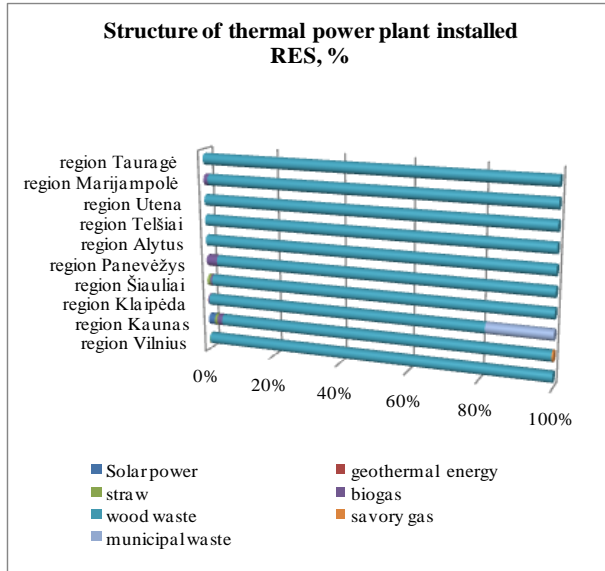

Figure 2. Percentage of technology utilization by Lithuanian regions in the heat sector.

It is shown in Figure 3, the situation in the electricity sector is better because different types of RES-E are used in a proportionate manner. This proves that it is possible to maintain a certain proportion of utilization of RES, with proper selection of economic and financial support measures.

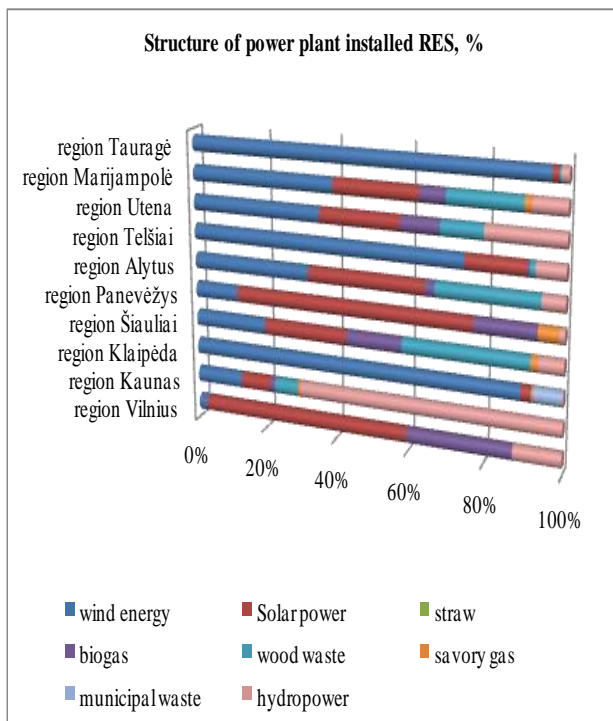

Figure 3. Percentage of technology utilization by Lithuanian regions in the power sector.

The stimulation of energy producers and consumers to use RES is one of the major goals of energy policy in Lithuania. Policies and measures that aim to enhance the use of RES are mainly driven by EU policy. Unstable state energy policy and changes of incentive measures destabilize the investment initiatives. The lack of economic evaluation on both demand and supply sides is the main challenge to achieve the expected goal.

The scientific problem is evaluation of social utility of RES that can show the advantages, which are underestimated in the investment decisions [16]. The most important benefits of RES are inexhaustibility and possibility to ensure sufficiency of energy resources for future generations. Also, utilization of particular RES technologies, such as solar energy, solves environmental issues. Therefore, RES may be additionally financed from other sources. The main issue is the diversity of RES utilization opportunities and incentives. The energy phenomenon is inexhaustibility of RES that could change exhaustible types of fossil fuel, such as oil and natural gas, and could be replaced with few different types of energy. This could be solar, wind, and geothermal energy. On the other hand, social utility of RES differs from the social utility of oil and natural gas, because RES guarantees the supply of energy resources for future generations.

Renewable energy policy is a complex system, where a balance among three aspects of sustainability – environment, economy, and social life – is needed. A good performance and well-balanced RES policy requires efforts from different stakeholders. Although each country has different starting conditions, namely, developed technical infrastructure and own energy resources, development of energy from RES should be shaped on the basis of long-term macroeconomic policy [17]. This means that a good and scientifically-based theoretical background is needed as well as indicators reflecting economic development and a method for assessing the impact of certain type of energy from RES on these indicators are required. In other words, this is a reliable energy supply at an affordable price, which causes as positive environmental impact as possible.

Support for RES is required to promote wider use of renewable energy. What is more, energy market failure is a serious obstacle to promote the development of RES. External positive benefits of using RES, such as public interest, are not evaluated here. This benefit is related to introduction of new technologies, their development, and positive impact on the environment [18][19]. Subsidies for RES must be based on a positive external utility. Therefore, one of the most effective methods could be integration of RES technologies into regional energy development [20]. Regional programs may be appropriate tools for subordinating market mechanisms (reducing renewable energy adaptation costs, increasing competitiveness in the market and promoting the development), which are required to overcome market barriers [21][22].

As a rule, the impact of RES-technologies on economic and social indicators is supported by statistical correlation analysis based on historical trends in RES development and their impact on macroeconomic indicators. However, the



anonymity of this method and the probability of a certain error cannot provide a clear understanding of the actual impact of specific parameters when analysing specific projects under individual RES-technologies [23]. Also, this method does not provide tools or ways to optimize the development of the RES-Sector or to put in place support measures to maximize macroeconomic benefits with minimal resources. Therefore, valuation is inseparable from the microeconomic analysis of the project chosen by the individual investor (taking into account the economic benefits to the developer), using external parameters for macroeconomic indicators [24]. Results obtained in one project may be interpolated to assess the potential impact of the support scheme at the urban level.

Levelized Cost Of Energy (LCOE) is one of the most popular approaches for comparison of different energy generation options on equal basis – present value of total life-cycle cost. The modified LCOE approach, which was applied in a paper of V. Bobinaite and D. Tarvydas [25] gives an opportunity to quantitatively assess the influence of certain RES support measures on the cost of energy production. Also, it provides the investors a tool which could be used to compare different RES investment projects concerning external benefit to society.

This method with a broad interpretation was adapted to assess the use of wind energy in the macroeconomic framework [3].

### III. SPATIAL ASPECT FOR THE ASSESSMENT OF BENEFIT FROM USING RES TECHNOLOGIES IN URBAN AREAS

There is no consensus among scientists in the debate on who should take initiative and responsibility in addressing the issues of the dissemination of innovation as a precondition for economic development: the state, the city or private structures. The basic idea of the problem above has expressed prominent environmentalist: "Global must move towards a local one, because localities exist within the boundaries of nature, where global exists only in the offices of the World Bank and the ICF and in multinational offices. Global ecological space is the local integration of everything" [26]. More and more scientists say that decisions are needed in this area by territorial units. The key issue is, in the long term, to achieve the possibility that different types of RES would find a niche in the long run, which basically means the stability of energy prices and the assurance of all elements related to sustainable development. In essence, this means consolidating the knowledge system into an effective set of practical implementation. Reproduction of good practice in this regard is an increase in the competitiveness of the whole economy, since it eliminates many negative factors associated with fossil fuel combustion. Also, burning biofuels causes not only the air pollution problem in cities, but also the degradation of forests despite the alleged reforestation of the forests.

The use of renewable energy in rural as well as urban areas became the significant development thus adding to mitigation of climate change, reducing differences between rural and urban dwelling options [27], bringing new RES

options for diversifying energy supply [28]. The role of local governance for energy and urban development appears highly important here [29].

Policies and measures that aim at enhancing the use of RES are mainly driven by EU policy. The scientific problem is evaluation of social utility of RES that can show the advantages, which are underestimated in the investment decisions [30][31]. Moreover, it is transfer of their economic interpretations on uniform rules and economic laws into specified dimension, in this case trying to reduce different opinions as much as possible [32].

The main indicators of external benefit are considered to be the use of domestic capital; taxes paid to the state budget and newly created job positions. Combination of different types of RES may create a large external effect and make a significant impact not only on individual consumers of RES, but also on the society. Therefore, the benefit from using RES, especially in urban areas, should be evaluated during the decision making process.

At the moment, a very important scientific problem emerges, namely the performance of non-profit organizations, such as municipality in the context of a knowledge-based economy. The main feature is that knowledge, for example, related to the sustainable development of energy, in particular the widespread use of renewable energy sources, as vital for global climate change mitigation, is becoming less an expression of the desire for competitiveness as an object of implementation and dissemination of good practice. In the current new economic situation, the main emphasis is on knowledge dissemination. On the other hand, they become an effective tool in the non-dispersed, random, but organized way to achieve a particularly important goal - massive absorption of RES technologies, which covers many positive additional effects – reducing environmental pollution, energy, in particular heat price stability, social issues, etc.

Each RES has different value in terms of external benefit, thus respective promotion schemes can and must differ significantly. This depends on the environmental situation in certain area. External conditions and current infrastructure for RES technologies differ, thus spatial planning, such as urban energy development plans, is the most appropriate tool for the benefit assessment. All countries pay little attention to the support of RES technologies on the demand side. Support for the consumers is the most appropriate via support programs (and not by supporting scattered consumers), as it enables to achieve actual effect. The external benefit analysis for small wind power plants, geothermal heat pumps, and solar collectors was performed to find their niche in urban and rural areas. The external effect indicators for different scenario cases are shown in Table I. Data in Table I show the comparison of external benefit using different types and scale of RES technologies. The main indicators of external benefits are considered to be the use of domestic capital; taxes paid to the state budget and newly created job places. Avoiding air pollution is also one of the key factors that determine the external utility of RES-technologies.

TABLE I. EXTERNAL BENEFIT OF USING SOLAR, WIND AND GEOTHERMAL ENERGY TECHNOLOGIES (CASE OF LITHUANIA)

Indicators	Wind power plants		Geothermal heat pump and solar collectors in multifamily building	Solar collectors in district heating system
	4 kW	10kW	126kW	7000kW
Production, MWh	6,8	17,5	185	4500
Domestic capital, 1000 EUR	8.02	21.08	25.01	1380.88
Social insurance, 1000 EUR	0.81	1.51	9.27	119.23
Personal income taxes, 1000 EUR	0.29	0.55	3.46	44.46
New jobs (man months)	2.3	4.2	31.9	409.4

Combination of different types of RES may create a large external effect and make significant impact not only on individual consumers of RES, but on the society as well. Therefore, the benefit from using RES, especially in urban areas, should be evaluated during the decision making process. If direct support is applied for RES or environmental technologies, the impact will depend on the volume of support and the source of funding. For example, if the direct assistance is financed from the state budget, the promotion measures would increase the budget deficit in addition to the positive aspects mentioned above. Therefore, it is essential that the promotion would be cost-effective: the benefits should exceed the negative effects. Inexhaustible types of RES (wind, solar, and geothermal energy) enable greater benefit than the subsidies it might require, while penetration into the market is growing.

Therefore, in the world and especially in the EU countries, many cities are taking initiatives to replace RES fossil fuels with RES technologies and thus greatly improve the living conditions of society cities that are committed over a period of time reaching 100 percent supply of energy from RES. There was a number of attempts to move in this direction. It seems that it requires billions of funds. However, the circular economy theory and facts that are supporting this theory shows that enhanced support and funds are necessary for the initial stage, especially during formation process of information systems. However respect for the environment is rarely considered the unconditional value of business relations. Educational activities are necessary, which would show the connection between human activity and eternal laws of nature. A special role in this process is attributed to smaller cities and rural or suburban communities. It will be a long process of transformation, but this is one of two alternatives: the continued destruction of the natural environment or the circular economy based on the above principles.

The key elements are: the strategic goal set before 2050 to achieve 100% supply of RES. (Lithuania has to provide 23% of final energy consumption by 2020). This means that all RES and energy saving tools find their niche in the

overall energy development. The tax policy, which is the main economic element, is characterized by the fact that significant energy taxes on fossil fuels are applied. This makes it possible to compare the competitive capabilities of fossil fuels and RES technologies by eliminating external costs that do not appreciate the use of fossil fuels in financial accounting. One of the key points is that infrastructure is optimally used, for example, centralized heating systems, which ensures a high level of utilization of RES-technologies.

The idea of eco-villages has been analysed since the last decades of the XX century all over the world. Modelling methods were used for resources management and sustainability assessment [33]. The most recent research concentrates on eco-innovations, eco-efficiency and eco-effectiveness, cultivations of eco-sustainability on various social-economic-environmental levels. The investigations also involve the role of eco-cultural diversity, renewable energy in eco-communities and understanding the eco-complexity and ecosystem approach [34].

The principle of ecological movement can be expressed by the quote “think globally, act locally”. Progress in solving environmental problems can be achieved more quickly if the principles of our activities and the functions of natural laws system are harmonized. This was the main principle of the development of green settlements. The energy sector of green settlements duplicates the processes in the nature, which is a perfect example of waste-free technology. The volume of waste generated in energy sector can be reduced by increasing the usage efficiency of primary energy sources and promoting the use of RES. The negative impact to the environment can be mitigated through more efficient use of RES in energy sector developed under the circular economy model and bioregional development principles. The use of RES in the regions can create unique environment for resource utilization. The exploitation of energy resources must not exceed the nature’s resilience limits otherwise RES can be treated as non-renewable resources. The development of regional energy sector, according to the principles of circular economy, is encouraging the use of a wide range of local and renewable resources.

#### IV. BALANCING OF RES SUPPORT FORMS BY USING SPATIAL PLANNING METHOD

In the legal system of Lithuania, self-government has been given fairly broad opportunities to participate in the development of energy efficiency and the use of renewable energy resources. The Law on Local Self-Government of the Republic of Lithuania distinguishes between independent functions of municipalities, including the preparation and implementation of municipal planning documents and planning documents implementing them. Thus, municipalities are required to prepare and implement their territorial planning documents and have the opportunity to include in them measures for the development of energy efficiency and renewable energy sources (on the other hand, they also have a delegated function delegated by the Ministry of Renewable Energy

Act to develop renewable energy the resources of the development plan. Municipalities also administer the implementation of the measures of the rural development program in the form of a state-delegated function. However, these documents may only become a routine accumulation of unrelated obligations. Only an organized set of knowledge permits the conversion of these program documents into what their initiators motivate a special purpose - the massive use of RES reclamation.

Exactly the municipalities, according to their responsibilities and functional structure, there are those organizations that could implement RES technologies on a large scale. However, it needs to be understood that the RES project will be one of many parallel programs and will only be figures if the benefits to other related programs at the state and municipal levels are not assessed. One of the major problems with the knowledge economy is the creation of separate programs with different goals and sources of funding.

Different types of RES have a very broad and distinctive scale of use therefore, each renewable requires its own specific support. This topic has been focussed on the potential analysis of wind, solar, and geothermal energy for small scale applications. Every renewable has a wide developing scale of technologies, which is becoming cheaper due to the growth of supply. What is more, every renewable has different significance level in terms of external benefit, thus support schemes can differ significantly. This depends on the environmental situation in various areas. External conditions and current infrastructure, where RES technologies could be applied, differ as well; therefore, spatial planning via urban energy development plans is the most appropriate tool for benefit assessment.

Most countries support RES technologies mainly on the supply side, while existing opportunities to use solar energy at the consumers' side, such as small systems of solar collectors in multi-apartment buildings, are significant as well. Support for the consumers is the most appropriate via support programs (and not by supporting scattered consumers), as it enables achieving actual effect. Renovation of buildings by districts enables planned actions, which could solve technical and financial problems for district heating companies due to reduced consumption.

Application of the schemes mentioned above for small producers increases administration costs and is often not acceptable due to high complexity level. Therefore, territorial administration is needed. The main problem is that the programs for implementation of legally delegated functions have no consolidating unity. This might lead to serious problems: renovation of multi-apartment residential houses would reduce the heat consumption significantly. As a result, the district heating tariffs would increase due to growing fixed heat generation and supply costs.

Although the EU directives and national laws provide for the functions of the municipalities of the Republic of Lithuania in developing software documents for the energy sector in general and for RES-technologies are rather precise, in practice, plans are just beginning to be formed. Having analysed the current laws of the Republic of

Lithuania, it is clear that they regulate in a sufficiently detailed manner the responsibilities of municipalities and the development of the use of RES. But the main problem is that separate programs are being developed for the implementation of individual EU directives, which do not have a consolidated unity. Meanwhile, functions such as the Special Needs Planning Development Plan, as well as future Environmental Protection Plans, which are already beginning to plan for the implementation of commitments made under the Paris Agreement, are directly linked to the development of RES, are formed separately. In this way, the financial resources and modest forces of specialists working in municipalities are dispersed. A stable and balanced program with carefully selected subsidizing, enabling the interaction between consumers and heat suppliers, is necessary for solving these problems, as proposed in Figure 4.

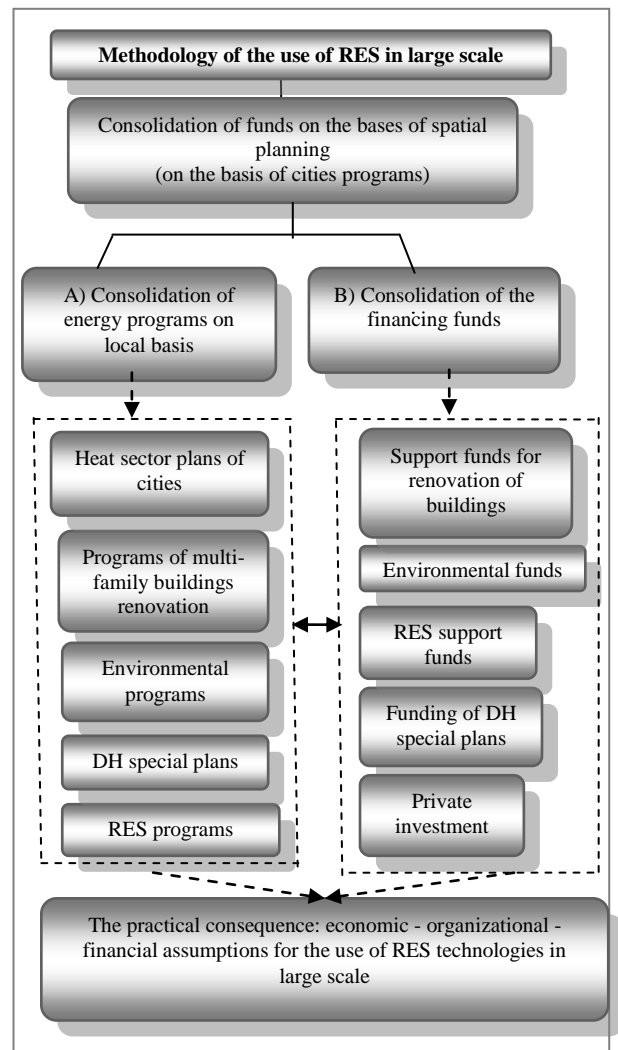

Figure 4. Methodology of the use of RES in large scale.

Periodization of economic age and assessment of various RES support forms, with regard to the specifics, has

different goals and tasks from the macroeconomic perspective.

There are two blocks of local programs and financing sources, which are to be described: A) and B).

*A. Consolidation of cities energy programs on the uniform basis of knowledge economy*

Lithuanian legal system of self-government has granted fairly broad opportunities to participate in increasing energy efficiency and development of renewable energy. Law on Local Self-Government in Lithuania distinguishes independent functions of municipalities, such as preparation and implementation of municipal strategic planning documents and planning documents implementing them. Law on Energy from Renewable Sources initiates preparing local RES development plans. Municipalities also administer the implementation of measures of Rural Development program such as carrying out the delegated function of the State. Law on Local Self-Government establishes that municipalities organize the heat supply within their territory. Law on Heat Sector regulates the special planning of heat, which is one of the implementation mechanisms of those obligations. In addition to broad responsibilities for the preparation of planning documents, the role of municipalities has been reinforced for renovation (modernization) of multi-family buildings in recent years.

The need for single energy policy formation with an economic support system for RES (as one of the compounds) has been notified for several years already.

Through the INTERREG RUSE project, we had the opportunity to get acquainted with examples of dozens of countries in the field of good practice in RES-industry. Particularly noteworthy is that the best results are achieved when municipalities play an active role in the field of implementation of RES projects. Several key moments are typical and characteristic: (a) the adoption of RES-technologies is a key element of all environmental programs; b) state-owned funds can use cities for environmental protection according to the extent to which they plan to acquire RES-technologies; c) households are one of the most important objects in the installation of low-power RES-equipment.

This process has been going on for a long time and is not just a declaration and not just declarations. In parallel, in the world, and especially in Europe, long-term programs are being developed and implemented in order to ensure that cities and regions receive energy from purely RES-technologies. There are about 40 such cities in Germany. It is worth noting that all cities that have announced these ambitious plans are focusing on a wide variety of R & D and the development of smart grid technologies. It would seem that this requires billions of EUR, but the theory of circular economics and the evidence of this theory show that more support and resources are needed at an early stage. Consolidation of programs according example presented in Figure 5 would be a good solution as RES have a significant impact on various aspects and especially in the formation of consolidated financing fund program.

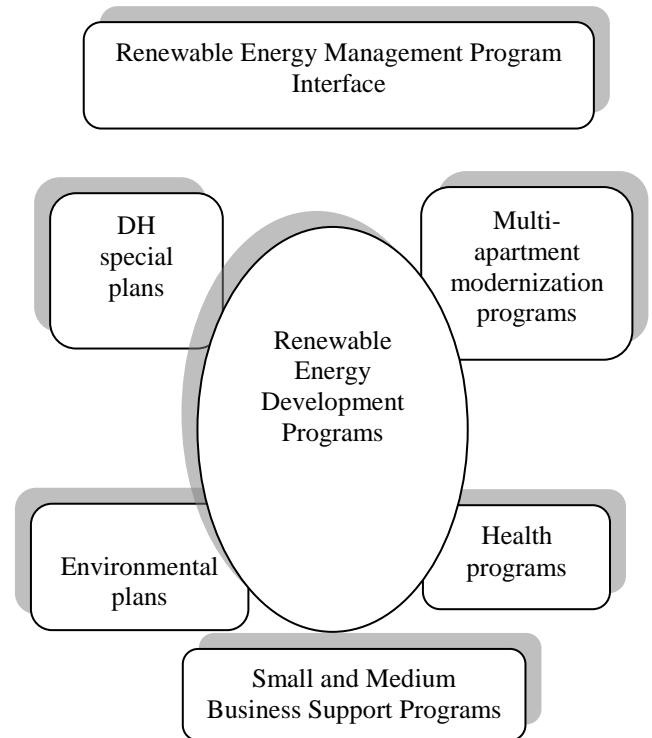

Figure 5. Renewable Energy Management Program Interface.

Such program consolidation might be organizational and the integration of RES technologies could be financed using Structural Funds simultaneously solving the tasks of other related programs.

They continue to become a normal business, except that respect for nature is rarely seen as an unconditional value in business relationships. Educational activities are needed that would demonstrate that the link between human activity and the eternal laws of natural evolution, which supports human viability, is interrupted. Particular role in this process is attributable to cities and smaller rural or suburban communities. And although this will be a long process of transformation, it is one of two alternatives - either further destruction of natural environment or the adoption of economy that would operate in circular economies.

*B. The second block shows consolidation of the financing funds program for sustainable development.*

It is necessary not only to foresee the results that are expected in the use of RES but also to form the best prerequisites and financial resources that it would be possible to realize positive external effects. However, considering the possibility of incorporating efficient use of resources and RES into planning documents of municipalities, there is an issue of financing. Independent functions of municipalities, including implementation of the program documents, are funded from local budgets. These funds are limited; therefore, it is difficult to expect a decision of allocating funds to these areas on a larger scale.

Therefore, the main role of municipalities is organizational, which would allow mobilizing larger resources. A special issue is lack of energy specialists who could prepare complex programs.

Scattered generation character and the fact that most of these installations can be implemented on demand side are left for private initiative. In order to involve hardly competing energy sources, the institution for investment management is required. Municipalities could act as institutions seeking for the development of wide scale RES technologies. Actual legislation in Lithuania shows that municipal powers and responsibilities regarding RES are regulated in detail. There are no barriers, except financing issues for the actions of municipalities. Some of them have signed the Covenant of Mayors; some have adopted RES development action plans, however, only a few of them are actually acting.

The promotion of RES on wider scale was implemented in EU by creating green settlements or the so-called eco villages [35]. For example, the state funded project Climate Menu in Netherlands, which enabled towns to select sectors which needed exceptional attention in order to meet national obligations. Environmental policy is implemented by towns, where the best possibilities are concentrated and problems are the most visible.

However, when considering the possibility of including efficient resource use and RES in municipal planning documents, there is a question of financing. The implementation of autonomous functions of municipalities, including the implementation of program documents, is financed from municipal budgets. These funds are limited, so it is difficult to expect decisions to spend on these areas at a wider scale. The functions transferred by the state to municipalities are financed from the state budget or state funds and transferred to municipalities as a special targeted grant. In any case, financial resources can only be very modest and dispersed according to individual programs, which is why the central role of city authorities is organizational, which would allow mobilization of larger resources. A particular problem is the lack of energy specialists who can develop complex programs.

Therefore, the most important prerequisite for solving financing issues may be the public-private partnership - long-term cooperation between the public sector body and the private-sector partner in the implementation of the complex of activities (for example, the design, construction, reconstruction, repair and maintenance of the infrastructure). However, in our opinion, this concept needs to be extended to the justification for financing sustainable urban development programs, consolidating and managing the funds on this basis for implementation of the program. In the field of financing RES, it is possible to use examples of various regional and even global partnerships. They play an important role in financing the RES sector in developing countries (Figure 6). Financial resources of the private sector for RES projects implementation have become attractive in the last few decades.

This diagram shows how cities can form consolidated funds on a public-private partnership basis. For this,

essential conditions are required - the formation of city information systems and programs that are required to be drawn up by law into a long-term integrated urban sustainable development program that synchronizes and duplicate individual short-term plans.

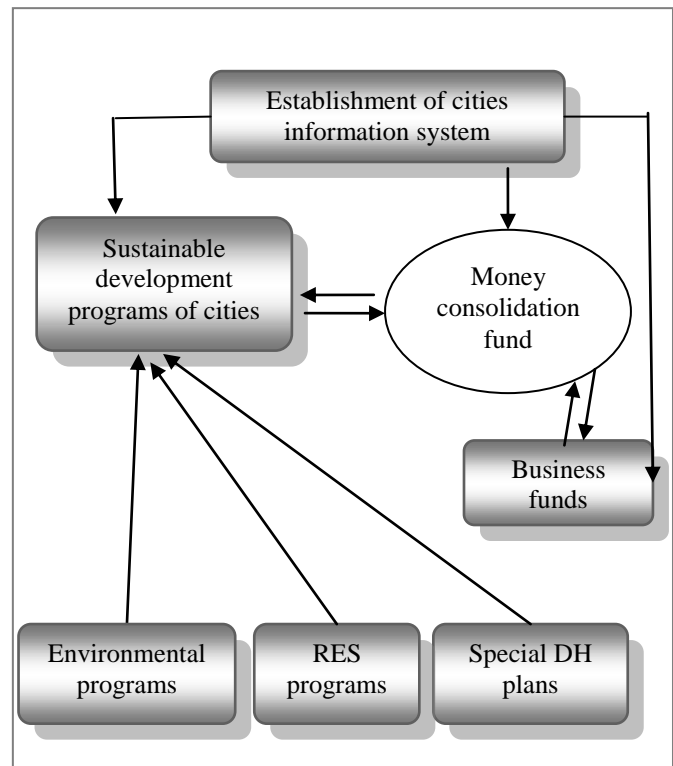

Figure 6. Financing opportunities system for RES technologies in Lithuania

In general, environmental programs in all parts of the world are based on wider use of RES, and the centralized heat supply plans could become the most rational instrument for combining various renewable energy projects into a coherent system, both on production and on the consumer side.

These financial resources are used in the public sector for infrastructure construction and maintenance purposes as well as for industrial equipment installation. However, examples of developing countries show that RES sector funding by using internal private financing channels are limited. Liming and Behrens distinguish several reasons why the involvement of the private sector is insufficient:

- investments in the RES sector have characteristics of public goods (i.e., costs and benefits are not always experienced by the same economic entity);
- developing countries do not have effective legal regulation of environmental sector;
- initial capital costs of RES technologies are high;
- there are additional risks caused by long payback period of technologies;

- higher than normal investment risks (such as market and currency risks) require a higher return on investment in developing countries;
- transaction costs of small and medium-sized projects are relatively high.

Therefore, the aforesaid reasons are due to the fact that RES sector is not always attractive to private investors in developing countries. In order to attract private sector investment, it is recommended establishing public-private partnerships. Moreover, the use of existing measures is recommended.

Figure 3 shows that cities can form consolidated funds on the principle of public-private partnerships. This requires fundamental conditions, such as forming cities' information systems and programs, which are mandatory by law, into the long-term unified urban sustainable development program that will synchronize and avoid duplication of individual short-term plans. Basically, environmental programs in all countries of the world are based on a wider use of RES, and special DH plans could become the most rational measure combining various RES projects into the unified system on both production and consumer sides.

The role of Government in financing RES sector is ambiguous because the role of Government is highly dependent on economic, social, and political environment. Thus, the role of Government in financing RES sector could be both active and passive. The Government solves problems of energy security and access to energy, job creation, improving the competitiveness and economic growth; RES sector could greatly contribute to resolving such problems. Therefore, the Government in this case actively participates in financing RES sector. There are several reasons why the Government takes active role in RES sector. Firstly, the Government financial support allows filling in the gap between the private sector's supply of investment and demand for investment. Secondly, the Government understands that the social return of investments in the RES sector is significantly higher than the private (individual) return. As a consequence, the Government increases social returns by creating economic incentives for investors. Some authors emphasize that governmental funding remains the most important source of funding RES sector in developing countries. Active role of the Government starts during implementation of national programs, providing subsidies, soft loans, loan guarantees, and tax incentives. The Government assistance with a mobilizing investment of private sector into RES sector has been increasing in recent years.

Partnership advantages are that the risks of implemented project are distributed among partners, according to their abilities to manage risks. Moreover, public-private partnerships ensure necessary investments in the public sector;

- ensuring timely and better quality public services;
- in many cases, projects are implemented on time and does not require additional unforeseen public expenditures;

- private sector entity is given an opportunity to ensure long-term income;
- during implementation of projects, private sector skills and experience are used;
- proper allocation of risks allows reducing costs to control them.

Of course, there may be disadvantages, such as developed infrastructure, or services could be more expensive;

- delaying public sector payments of the partnership project to the future it could be adversely affected subsequent periods of public sector fiscal indicators;
- purchase of services through partnership takes longer and is more expensive compared with traditional public procurement;
- partnership projects are long-term, complex and relatively inflexible contracts because it is difficult to predict and assess all factors which may affect the future performance of the envisaged activities.

## V. CONCLUSION

A particular obstacle to the widespread use of RES is the lack of evaluation of the benefits to society (reduction of pollution, energy supply of the future for generations, huge and never-ending potential of energy resources such as solar, wind energy) when introducing RES-technologies. Therefore, when formally calculating, RES-technologies are not sufficiently competitive compared to fossil-fuel technologies. This work deals specifically with the problem of the impact of RES-technologies.

There are controversial phenomena, especially in the heat sector, where huge disproportion of used RES has appeared. Unreasonably huge role is assigned to biomass in usage projections of RES. Biomass is an energy resource that is the result of economic activity and depends on continuity of economic activity. Meanwhile, the use of an inexhaustible solar and geothermal energy potential is absolutely insufficient.

The analysis of positive and negative impact of the use of RES on research in Lithuania and other countries has shown that major part of the positive impact of the development of RES is related to GHG and other pollutant emissions, job creation and rural development, increase in employment in the regions, the reduction of heat prices and the lower emissions of some fossil fuels. Investigation has allowed the formation of a targeted, reliable methodology compatible with the status of existing statistical information.

Each RES has a different value in terms of external benefit, thus respective promotion schemes can and must differ significantly. This depends on the environmental situation in certain area. External conditions and current infrastructure for RES technologies differ, thus spatial planning, such as urban energy development plans, is the most appropriate tool for the benefit assessment.

More and more scientists say that decisions are needed in this area by territorial units. The key issue is, in the long term, to achieve the possibility that different types of RES would find a niche in the long run, which basically means



the stability of energy prices and the assurance of all elements related to sustainable development. In essence, this means consolidating the knowledge system into an effective set of practical implementation.

The methodology, which is based on spatial planning, identifies certain aspects that usually are not covered by routine investment evaluation techniques, namely, the existing problems in cities: high atmospheric pollution, unemployment, etc., may determine validity conditions that allow interpolating results to assess technology for spatial energy planning for solving problems mentioned above. Combination of different types of RES may create large external effect and make a significant impact not only on individual consumer of RES, but on the whole society as well. Therefore, the benefit from using RES, especially in urban areas, should be evaluated during the decision making process.

Urban programs should be the main form for consolidation of investment funds and promotion on the basis of possible rational use of investment as a complex macroeconomic effect can be measured and achieved on the territorial basis.

#### REFERENCES

- [1] V. Klevas and A. Kleviene, "The sustainable growth use of renewable energy based on spatial energy planning," The Tenth International Conference on Bioinformatics, Biocomputational Systems and Biotechnologies BIOTECHNO 2018 IARIA, May 20 - 24, 2018, ISSN: 2308-4383. ISBN: 978-1-61208-639-2.
- [2] European Council. Directive 2009/28/EC of the European Parliament and of the Council on the promotion of the use of energy from renewable sources and amending and subsequently repealing Directives 2001/77/EC and 2003/30/EC. Off. J. Eur. Communities, 5.6.2009, L 140/16, 2009.
- [3] V. Klevas, V. Bobinaite, M. Marciukaitis and D. Tarvydas, "Microeconomic analysis for the formation of renewable energy support policy: the case of wind power sector in Lithuania," Engineering Economics, ISSN 1392-2785, vol. 29, No. 2, pp. 188-196, 2018, doi: org/10.5755/j01.ee.29.2.13626.
- [4] Y. C. Shen, G.T. Lin, K. P. Li, B. J. and C Yuan, "An assessment of exploiting renewable energy sources with concerns of policy and technology," Energy Policy, vol. 38, pp. 4604–4616, 2010, doi:10.1016/j.enpol.2010.04.016
- [5] European Commission. State aid: Commission adopts new rules on public support for environmental protection and energy [Online]. Available from: [http://europa.eu/rapid/press-release\\_IP-14-400\\_en.htm](http://europa.eu/rapid/press-release_IP-14-400_en.htm). 2014
- [6] European Commission. European Commission guidance for the design of renewable energy support schemes, Commission staff working document, 2013
- [7] A. C. Marques, J. A. Fuinhas and J. R. Pires Manso, "Motivations driving renewable energy in European countries: a panel data approach," Energy Policy, vol. 38, pp. 6877–6885, 2010, doi:10.1016/j.enpol.2010.07.003.
- [8] R. Camagni, "On the concept of territorial competitiveness: sound or misleading?" Urban Stud., vol. 39, pp. 2395–2411, 2002.
- [9] B. J. de Vries, D. P. van Vuuren and M. M. Hoogwijk, "Renewable energy sources: their global potential for the first-half of the 21st century at a global level," Energy Policy, vol. 35, pp. 2590–2610, 2007, doi:10.1016/j.enpol.2006.09.002.
- [10] N. L. Panwar, S. C. Kaushik and S. Kothari "Role of renewable energy sources in environmental protection: a review." Renew. Sustain. Energy Rev., vol. 15, pp. 1513–152, 2011, doi:10.1016/j.rser.2010.11.037.
- [11] A. Bergmann, S. Colombo and N. Hanley, "Rural versus urban preferences for renewable energy developments" Ecol. Econ., vol. 65, pp. 616–625, 2008, doi:10.1016/j.ecolecon.2007.08.011.
- [12] J. Hofierka and J. Kaňuk, "Assessment of photovoltaic potential in urban areas using open-source solar radiation tools," Renew. Energy, vol. 34, pp. 2206–2214, 2009, doi:10.1016/j.renene.2009.02.021.
- [13] W. T. Chong, M. S. Naghavi, S. C. Poh, T. M. I. Mahlia and K. C. Pan, "Techno-economic analysis of a wind-solar hybrid renewable energy system with rainwater collection feature for urban high-rise application," Appl. Energy, vol. 88, pp. 4067–4077, 2011, doi:10.1016/j.apenergy.2011.04.042.
- [14] P. Droege, "Urban Energy Transition", Elsevier, 2008, doi:10.1016/B978-0-08-045341-5.00029-3.
- [15] V. Castán Broto and H. Bulkeley, "A survey of urban climate change experiments in 100 cities," Glob. Environ. Change, vol. 23, pp. 92–102, 2013, doi:10.1016/j.gloenvcha.2012.07.005.
- [16] E. Strantzali and K. Aravossis, "Decision making in renewable energy investments: A review," Renew. Sustain. Energy Rev., vol. 55, pp. 885–898, 2016, doi:10.1016/j.rser.2015.11.021.
- [17] V. Klevas, "Justification of long-term economic policy of renewable energy sources New York: Nova Science Publishers, 2015," ISBN 978-1-63483-203-8 (print), ISBN 978-1-63484-020-0 (e-book),
- [18] G. Tanguay, J. Rajaonson, J. Lefevre and P. Lanoie, "Measuring the sustainability of cities: An analysis of the use of local indicators," Ecol. Indic., vol. 10, pp. 407–418, 2010.
- [19] Y. Xing, R. Horner, M. El-Haram and J. Bebbington, "A framework model for assessing sustainability impacts of urban development," Account Forum, vol. 33, pp. 209–224, 2009.
- [20] V. Klevas, Regional approach for policies and measures aiming to sustainable energy development. In: Paths to sustainable energy, Rijeka: InTech, pp. 117-132, 2010, ISBN 978-953-307-401-6.
- [21] V. Klevas, "Analysis of support assumptions and measures for promotion of renewable energy sources demand in regional aspect," Advances in energy research, New York: Nova Science Publishers, pp. 99–122, 2012, ISBN 978-1-61470-485.
- [22] V. Klevas, K. Biekša and L. Murauskaitė, "Innovative method of RES integration into the regional energy development scenarios," Energy Policy, vol. 64, pp. 324–336, 2014, doi:10.1016/j.enpol.2013.08.088.
- [23] R. Wang, D. Hu, F. Li and B. Larry, "Understanding eco-complexity: Social-Economic-Natural Complex Ecosystem approach," Ecol. Complex., vol. 8, pp. 15–29, 2011, doi:10.1016/j.ecocom.2010.11.001.
- [24] L. Dusonchet, E. Telaretti, "Economic analysis of different supporting policies for the production of electrical energy by solar photovoltaics in eastern European Union countries," Energy Policy, vol. 38, pp. 4011–4020, 2010, doi:10.1016/j.enpol.2010.03.025.
- [25] V. Bobinaite and D. Tarvydas, "Financing instruments and channels for the increasing production and consumption of renewable energy: Lithuanian case," Renew. Sustain. Energy Rev., vol. 38, pp. 259–276, 2014, doi:10.1016/j.rser.2014.05.039.
- [26] V. Shiva, "The greening of global reach", The Ecologist, vol. 22(6), pp. 327–328, 1992.
- [27] I. Harmaajärvi, "EcoBalance model for assessing sustainability in residential areas and relevant case studies in

- Finland,” *Environ. Impact Assess. Rev.*, vol. 20, pp. 373–380, 2000, doi:10.1016/S0195-9255(00)00048-2.
- [28] A.P. Palojarvi, “Experiences with ecological technologies and practices”, Vilnius: BMK Press, 2013.
- [29] K. Tzoulas et al., “Promoting ecosystem and human health in urban areas using Green Infrastructure: a literature review,” *Landscape Urban Plan.*, vol. 81, pp. 167–178, 2007, doi:10.1016/j.landurbplan.2007.02.001.
- [30] H. Bulkeley and M. Betsill, “Rethinking Sustainable Cities: Multilevel Governance and the Urban Politics of Climate Change,” *Clean prod.*, vol.14, pp. 42–63, 2005, doi:10.1080/0964401042000310178.
- [31] C. Kalenda, “Ecological ethics” [in Lithuanian], Vilnius: Rosma, 2007.
- [32] B. Bayulken and D. Huisingh, “Are lessons from eco-towns helping planners make more effective progress in transforming cities into sustainable urban systems: a literature review,” *Clean Prod.*, 2015, doi:10.1016/j.jclepro.2014.12.099.
- [33] D. Hu and R. Wang, “Exploring eco-construction for local sustainability: An eco-village case study in China,” *Ecol. Eng.*, Vol. 11, pp. 167–176, 1998, doi:10.1016/S0925-8574(98)00032-9.
- [34] Y.Y. Zheng and S. Gao, “Exploration on the Eco-Village Planning from the Perspective of Low-Carbon,” *Appl. Mech. Mater.*, pp. 357–360, 2013, doi:10.4028/www.scientific.net/AMM.357-360.1945.
- [35] H. Barton, “Sustainable Communities: The Potential for Eco-neighbourhoods”, London: Earthscan Publications, 2000.

## A Smart Healthcare Tracking and Monitoring System

Ali Bazzi, Majd Ghareeb, Samih Abdul-Nabi

Department of Computer and Communication Engineering,  
International University of Beirut, BIU  
Beirut, Lebanon  
{ali.bazzi; majd.ghareeb; samih.abdunabi}@b-iu.edu.lb

Muslem Ghamloush, Mostafa Ibrahim, Hassan  
Khachfe

Lebanese Institute for Biomedical Research and Application  
Lebanese International University, LIU  
Beirut, Lebanon  
{41030013; 41410026}@students.liu.edu.lb;  
Hassan.khachfe@liu.ed.lb

**Abstract**—Although technology advances cannot help in limiting the dreadful missing-in-action that occurs either in war or in dangerous sports, they could at least help in reducing its effects and casualties. One way to help in this aim could be by tracking and monitoring the location and health situation of the concerned persons. The main objective of the work presented in this paper is to design and implement a complete tracking system. The system is composed of a mini portable server, defined as a central unit hosted on a Raspberry Pi and used to monitor members' location, state, and health information. This will be done through wireless communications to small devices equipped with the necessary sensors and attached to the member's arm. Moreover, the system provides an emergency button to request help if pressed when the member is facing an urgent situation. A set of test cases has been applied and the results achieved by our prototype have presented a promising accuracy and efficiency when applying such a system.

**Keywords**-Healthcare monitoring; tracking system; Raspberry PI; Arduino; WIFI Communication.

### I. INTRODUCTION

As we already stated in [1], on September 28 1951, Daniel Hunt, from Columbiaville was a member of the 1st Battalion conducting operations near an area referred to as Heartbreak Ridge. The Chinese launched an attack, which the army repelled. Prior to their attack, the Chinese launched a barrage of mortar fire against the Americans in which survivors withdrew to friendly lines. Hunt was reported missing in action. During an investigation by the U.S. Army Casualty office, three members of Hunt's unit reported him been killed during the fight. The Army therefore declared him deceased. Today, 7780 Americans remain unaccounted for from the Korean War [2].

On the other hand, on February 13 2017, an avalanche in France has left four skiers dead and five missing when a mass of snow swept them away in the resort of Tignes. Resort workers reportedly witnessed the disaster, which struck an off-piste slope at around 10.30am local time, alerting emergency services. Mountain security authorities in nearby town Albertville said those who are unaccounted for are believed to be "buried under a large amount of snow" [3]. Thousands of cases like "Hunt" and the skiers are encountered around the world, showing that the issue of

unaccounted people is a common in wars, sports and other even of our daily life.

Some people believe that known communication tools can help to avoid problems encountered in the previously mentioned cases and save lives. In these cases and in all scenarios in this paper we define members as a group of people in a mission with a leader on the head of the mission. Monitoring members by their leader is not an easy task because of natural factors, lack of knowledge about the place of accident, loss of connection between the leader and the members, power failure of the tools, barrage jamming, and snow swept and so on, constitute obstacles limiting communication between members and their leaders.

These and many other problems have led researchers to think about new solutions benefiting from the evolution of technologies. Throughout the years, many technologies have been invented to solve the Missing-In-Action problem, but they remained weak. Most of these systems are based on tracking the movements of people in missions, which is not always an efficient way to detect threads and does not give the real status on the group on the ground. Navigating and situating are important, but need tiring activities which GPS (Global Positioning System) makes easier. The GPS has turned out to be a significant technology for the U.S. military and other defense forces around the world since the 1980's [3]. With the ability to provide accurate positioning continuously, day or night, in any conditions, GPS has helped ground troops in Iraq and Afghanistan navigate across expansive, barren deserts that have few markers or distinguishable features. Although GPS provides the position of skiers and hikers, it is still considered weak and far away from healthcare when any of health issues are faced during any type of missions.

From all the previously-mentioned issues, the objective of our paper is to present the design of a new "smart healthcare tracking and monitoring system" that would significantly reduce the effects of problems encountered through the literature review we conducted. Our system grants the leader the ability to track his team members on a map based application and monitor their health statuses in a continuous and real time way, even in upper mountains and hard conditions. This is done via a web interface installed on a stand-alone server or via a mobile application. This paper is an extension of the work presented in [1]. The rest of it is

organized as follows. In Section II, we talk about some similar applications to our system. Section III gives an overview of the system architecture and design. Section IV talks about the used components and describes the implementation in detail, and we conclude in Section V with a summary about the main contribution of this paper.

## II. RELATED WORKS

Medically, health statuses of members with critical conditions are a great concern for leaders who seek new and innovative healthcare systems. In the past, sports leaders were monitoring their members with the aid of primitive communication systems, such as the walkie-talkie, until the technological development enabled tracking systems using satellites.

### A. Walkie-Talkie

During the Second World War Donald L. Hings, radio designer Alfred J. Gross, and engineering teams at Motorola, invented a walkie-talkie. The hand-held, compact, two-way radio handset, utilized for field artillery and tank units. After the war, the basic walkie-talkie idea quickly expanded into a family of devices, the forerunners of later citizen's band radios in the 1970s and the first analog cell phones in the early 1980s [5].

This device improved the leader-members communication during and after a mission, however, this technology has a limited usage because it can't be used in a low-profile situation or in the case of injury. In addition, this device is energy consuming and sensitive to natural factors and man-made noises.

### B. Movement/tracking system

The United States Army invented a Movement Tracking System (MTS) that is a logistics communication platform under the Program Executive Office for Enterprise Information Systems (PEO EIS) [6]. It is designed for commanders (leaders) to track assets (members) on the battlefield with encrypted text messaging. It is a satellite-based tracking and communicating system designed to provide command and control between the leader and the soldiers.

This device can continuously monitor the soldier's location during battle, which improves the leader's control of the troops without the need for primitive communication tools which require manual usage. MTS's main disadvantage is that the health statuses of members remain absent from such systems.

### C. Smart systems for healthcare monitoring using communication means

In recent years, health monitoring systems have rapidly evolved recently, and smart different systems have been proposed to monitor patient's current health conditions. In a recent work [7], authors are proposing a "Smart real-time healthcare monitoring and tracking system using GSM/GPS technologies", which concentrates on checking the patient's blood pressure and body temperature. This system was built

for social healthcare in the light of GSM and GPS innovations and as a compelling application for real time health monitoring and tracking. In case of emergency, a short message service (SMS) will be sent to the doctor's mobile number along with the measured values through the GSM module. Moreover, the GPS gives the location data of the patient who is under observation all the time. While this system covers the issue of healthcare status provision, it cannot continuously track the person's required information. In addition, the usage of GSM to send short messages is more expensive and can face some limitations, such as when the doctor's phone is out of service or due to natural conditions in case of ski, etc.

In another work [8], authors proposed "Patient Health Management System". This system is based on smart devices and wireless sensor networks for real time analysis of various parameters of patients. This system is aimed at developing a set of modules which can facilitate the diagnosis for the doctors through tele-monitoring of patients. It also facilitates continuous investigation of the patient for emergencies looked over by attendees and caregivers. A set of medical and environmental sensors is used to monitor the health, as well as the surroundings, of the patient. This sensor data is then relayed to the server using a smart device or a base station.

Each of the systems discussed in this section provides a required and specific feature needed before, during and after a mission. Walkie-talkie system provides the aural communication between leader and members but the tracking of members functionality is missing. MTS provides continuous tracking of members' movements, but their health statuses are missing, "Smart real-time healthcare monitoring" system provides health statuses tracing, but not continuously, "Patient Health Management System" provides health monitoring using smartphones over the Internet or using servers to extract information.

In our design, we try to take full advantage of existing systems by combining their features in one small wearable device. An important advantage of our system compared to other products is manifested in its ability to simultaneously keep an eye on members' health status alongside their locations without the need for manual control, which facilitates leader-members communication, even on Upper Mountains and under hard conditions. Moreover, the central unit, unlike the systems discussed, is a small portable device to be held by the leader. It hosts the information locally without any need of larger servers or connecting devices between members and their leaders.

## III. SYSTEM DESIGN

In this section, we present a thorough description of our system design. This description encompasses four parts: the first, presents the use case and activity diagrams; the second, presents the system architecture; the third, shows the state diagram and the last one, contains the conclusion about the system overview. This description allows seeing the system from different perspectives and fosters a better understanding of its functionalities.

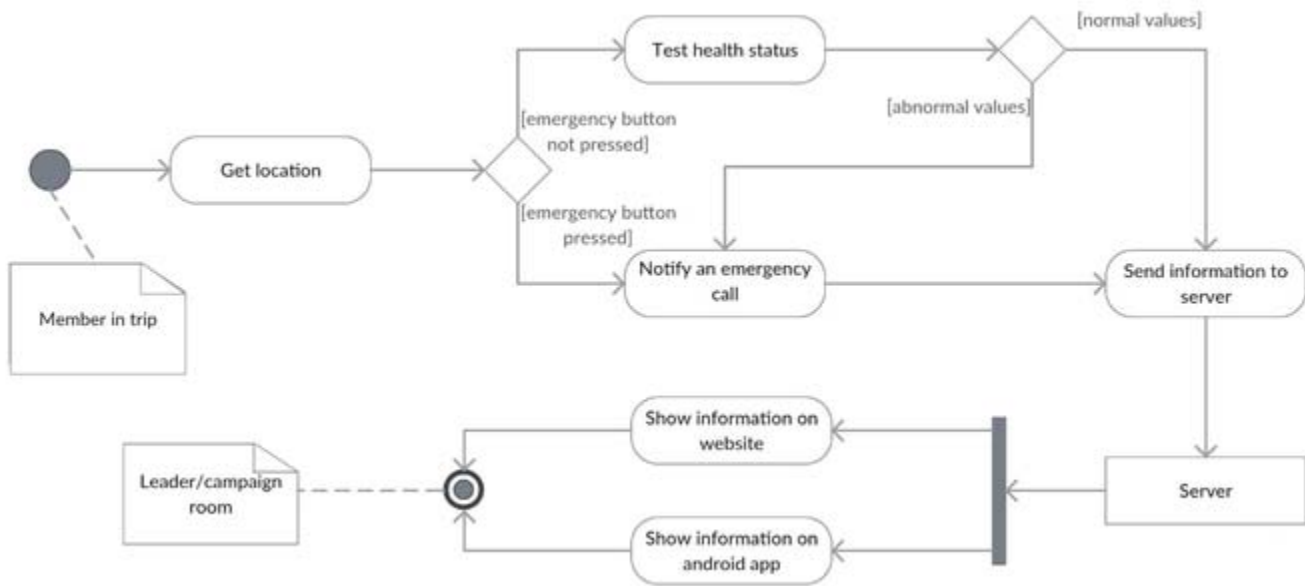

Figure 1: Activity Diagram of the system

#### A. Requirements and Specification analysis

In this section, the overall requirements of the system are defined together with the use cases of members and their leader; it also shows a UML activity diagram of the system.

- Each member requires a wearable device before the mission.
- This device records the heart rate, oxygen in the blood and body temperature of the member and sends data periodically to the server component.
- The device has a button which may be pressed in an emergency situation.
- On the other side, there is a device held by the leader and wirelessly connected with this wearable device.
- The leader requires a web browser or an android device, which are available on the leader's device to monitor his members.
- The system will notify the leader if any of the member's status is abnormal or an emergency request is taking place.
- The leader can track his members by receiving their locations from their wearable devices.
- A suitable decision is taken by the leader or monitoring room depending on the faced situation.

A use case diagram at its simplest is a representation of a user's interaction with the system that shows the relationship between the user and the different use cases in which the

user is involved. Figure 2 shows the use case diagram of our proposed system by identifying each user interaction with the system. The device held by a member has the capability of testing the life signs and send all required information to the server, it also provides an emergency button to use it when needed in any encountered issue. The system allows the leader or the monitoring room to closely track the members.

An activity diagram is another important diagram in UML to describe the dynamic aspects of the system. Figure 1 shows the same idea of Figure 2 but as flow chart to represent the flow from an one activity to another between members and their leader.

#### B. System Architecture

The system architecture shows the hardware and software side of the system. It is explained using a figure showing the placement of the equipment used and the role of each part. The software part is related to the server and the website or android application that used to monitor persons on maps.

Figure 3 displays the hardware part in detail by showing the member side as an Arduino, sensors required and the WIFI module. The leader side is shown as a Raspberry Pi, both connected to an access point to transmit and receive data. Note that the access point can be on the PI itself if members are close enough. This figure also shows the software part and how it obtains data from the server.

As depicted in Figure 3, we have two main components. The first one is the central unit that plays the role of a server and it is usually controlled by the leader. The second one holds the monitoring units worn by each member.

The central unit is portable with light weight and small size. For simplicity of connection, this unit could provide an access point to the members to make sure no intermediate equipment is needed. This server will host all the needed information, such as the database and the Web pages. Hence, data retrieval will be done locally and no need for any external connection such as GSM or Internet will be needed. This will help in increasing the system security, connection speed and data localization, since the information of the members does not need to be published on a large scale. This unit can be controlled via a Web application that could be accessed directly from the PI or via a mobile application that is designed to do the same objective.

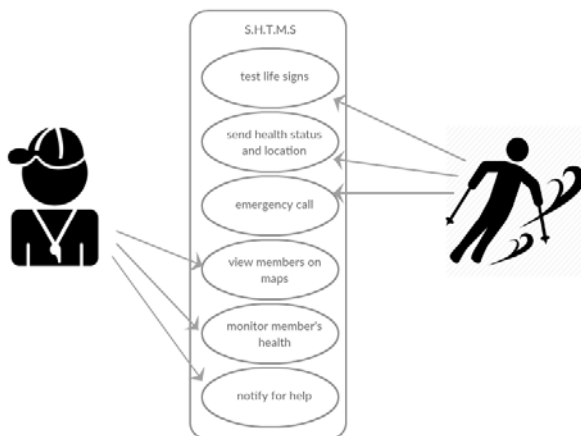

Figure 2: Use Case Diagram of the system

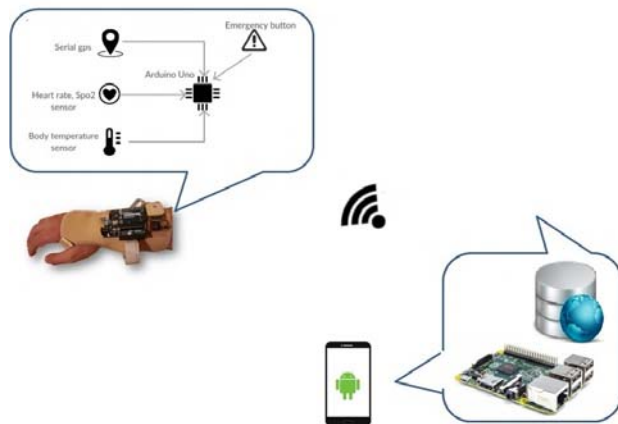

Figure 3: System Architecture Diagram

The other main component of our system is a small wearable glove that is equipped with all the sensors and detectors to connect members to their monitoring campaign or leader. This will be done by detecting body temperature, oxygen level in the blood, heart beat rate, speed and location of each member. All this information will be sent periodically and automatically to the central unit notifying

the leader of any issue, injury or maybe death. Additionally, system provides an emergency button that gives the member the possibility to request help when facing a non-medical urgent problem.

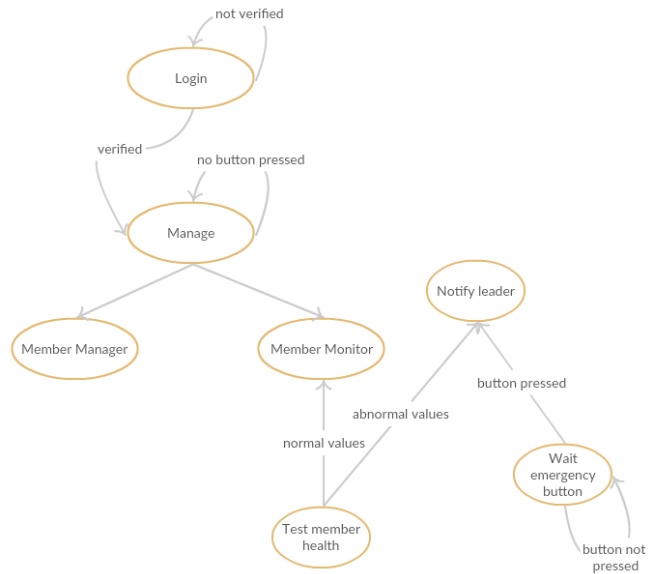

Figure 4: State Diagram of the system



Figure 5: Arduino Uno

### C. State Diagram

The state diagram in an additional design documentation needed to outlining the different stages of the system. A state diagram is used to model the dynamic nature of the system. It defines different states of an object during its life time, and describes the control from one state to another. In this part, the function of the system depends on the health status of members as shown in Figure 4. In addition, the leader after login in can either manage members or monitor them during the mission.

### D. Conclusion

System design can be a combination of use cases, system architecture, and state diagram, which are useful to give an idea about how this system works, from its start to its end. Also, defining the overall requirement of the system, such as hardware and software is important, and where to place and use them is helpful to know about what the system consists of. State diagram used to model the dynamic overview of the system, describes the control from one state to another, and



shows the starting and the ending point of the system lifecycle.

#### IV. IMPLEMENTATION TOOLS AND DETAILS

The proposed system is a smart healthcare tracking and monitoring system in Server-Client architecture. This system is collecting health status and locations of a member from one small wearable device to the server. The wearable device is Arduino UNO based and continuously sends member's statuses via WIFI connection without need for manual controlling to the server based on a Raspberry Pi and controlled by the leader. This system facilitates member-leader communication even in hard conditions.



Figure 6: Pulse sensor

##### A. Monitoring Unit implementation

In our system, the monitoring unit is composed of a microcontroller connected to a heart pulse sensor, oxygen level and body temperature sensor, serial GPS, emergency button, and ESP8266.

The Arduino Uno is a small, complete, and breadboard-friendly board shown in Figure 5. It has 14 digital pins, and each of them can be used as an input or output. It also has 8 analog pins, each of which provides 10 bits of resolution [9]. In this system, we used this type of Arduino just for simulation, but more practical prototype can be used to minimize the size of the device.

We connected the heart pulse sensor to an analog pin of the microcontroller. The pulse sensor shown in Figure 6 reads a waveform and calculates the BPM (Beats per Minute), as well as the IBI (Inter Beat Interval), which is the time between beats [10].

The oxygen level and body temperature are both measured using the MAX30100 chip shown in Figure 9. The only required connection to the sensor is the I2C bus (SDA, SCL lines, pulled up). The MAX30100 shown in Figure 9 is an integrated pulse oximetry, body temperature, and heart-rate monitor sensor solution [11]. The accuracy of the pulse sensor was better, so we ignored the heart rate value measured by MAX30100 and we used it as a supporter in case of fault within the heart pulse sensor.

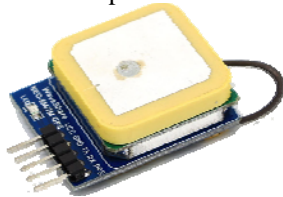

Figure 7: NEO-6M GPS Module

In addition, we used NEO-6M GPS Module shown in Figure 7 to measure the speed of each member beside his location as latitude and longitude values.



Figure 8: Touchable LCD screen with Bluetooth keyboard.

The serial GPS communicates serially with the microcontroller. This GPS Module uses the latest technology to give the best possible position information. Also, it comes with ceramic antenna.

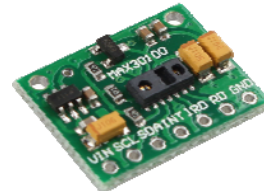

Figure 9: MAX30100 sensor

Finally, the microcontroller sends all measured values using serial communication to the WIFI module, which is connected to digital pins. The WIFI Module (ESP8266) shown in Figure 10 is programmed to get values from the microcontroller following a specific algorithm; then, it sends these values through WIFI to the central unit where the leader monitors. The ESP8266 is a self-contained system on chip with integrated TCP/IP protocol stack that can give any microcontroller access to any WIFI network. The ESP8266 is capable of either hosting an application or offloading all WIFI networking functions from another application processor.

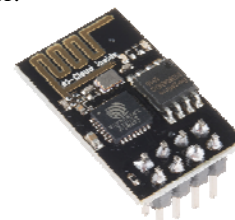

Figure 10: ESP8266 WIFI Module

The whole monitoring implementation board after connecting these components is shown in Figure 11.

##### B. Central unit implementation

Raspberry Pi with Linux operating system is the central unit. The leader can browse the Web page built for the system to track and monitor his members. In addition, we added a 7 Inch LCD touchable screen and a keyboard shown in Figure 8 to allow the leader to access the Web site directly from the server.

As shown in Figure 12, the central unit is a portable device with small dimensions (15 cm widths x 15 cm height and less than 10cm depth) so the leader can hold it during the mission. Even if hard conditions according, the metal box that built for this purpose is strong enough and allow the leader to stay connected with his team members.

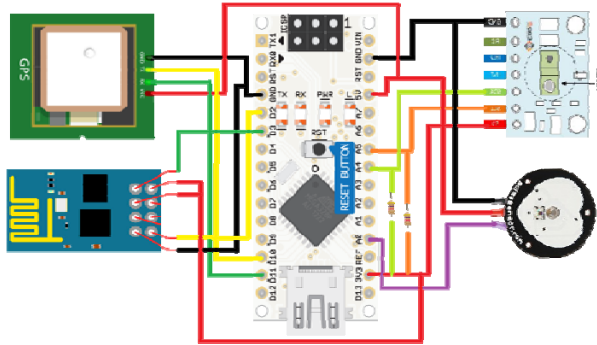

Figure 11: Monitoring unit implementation board



Figure 12: Portable central unit based on Raspberry Pi

The Raspberry Pi is a small computer with a processor, RAM (Random Access Memory) and graphics chip. It has various interfaces and connectors for external devices communication [12]. In our system, we configured it as a server. We used Raspberry Pi V3 Model B which has 512 MB of RAM.

### C. Webpage development

Each member in the trip held a user-friendly wearable device composed of the microcontroller, sensors required and a WIFI Module. A real prototype of the monitoring unit is shown in Figure 13.

The microcontroller gathers data from all sensors and sends them to the central unit directly using WIFI signals without passing through any access point.

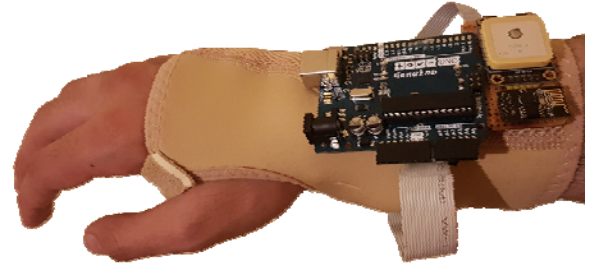

Figure 13: Member's wearable device

Each member must turn on his own device, which is programmed only for his unique I.D., without any need for any manual configuration. This device will send the member's I.D., health status and location information continuously. In addition, any member of the team with normal health status can notify his leader by pressing an emergency button if he needs any help. The leader can track and monitor his team directly from the small portable access unit, or any other PC connected locally to this unit, by accessing the Web page built for the system from any browser. After login, the Web page displays a map showing all the members in the trip or wearing their devices, as shown in Figure 16. The members are represented by markers; on mouse over Marker, a window will pop-up displaying the member's profile information, as shown in Figure 14.

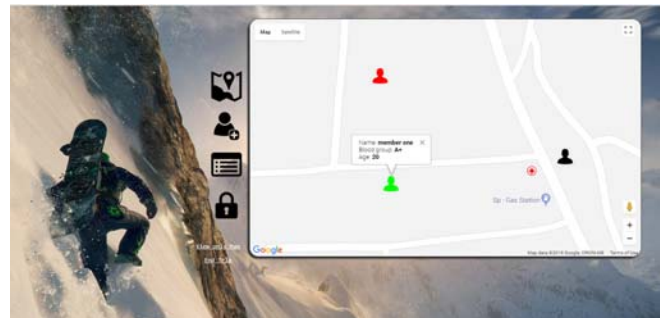

Figure 14: Shows a player in a normal case on mouse over icon

On mouse click on Marker, a window displays the member's health information, as shown in Figure 15.

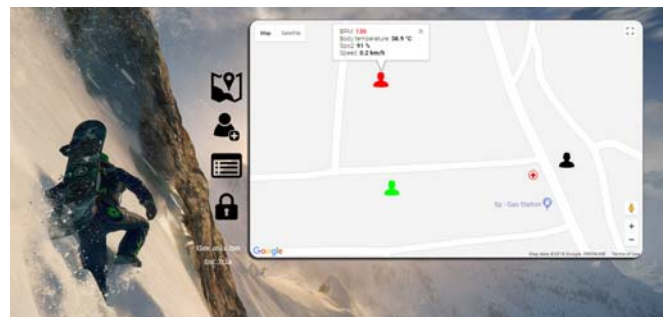

Figure 15: Shows a player in an abnormal case on mouse click on icon

The icon of a marker changes depending on the health status, or in case of an emergency as follows: A red icon indicates an anomaly in one or more value of life signs,

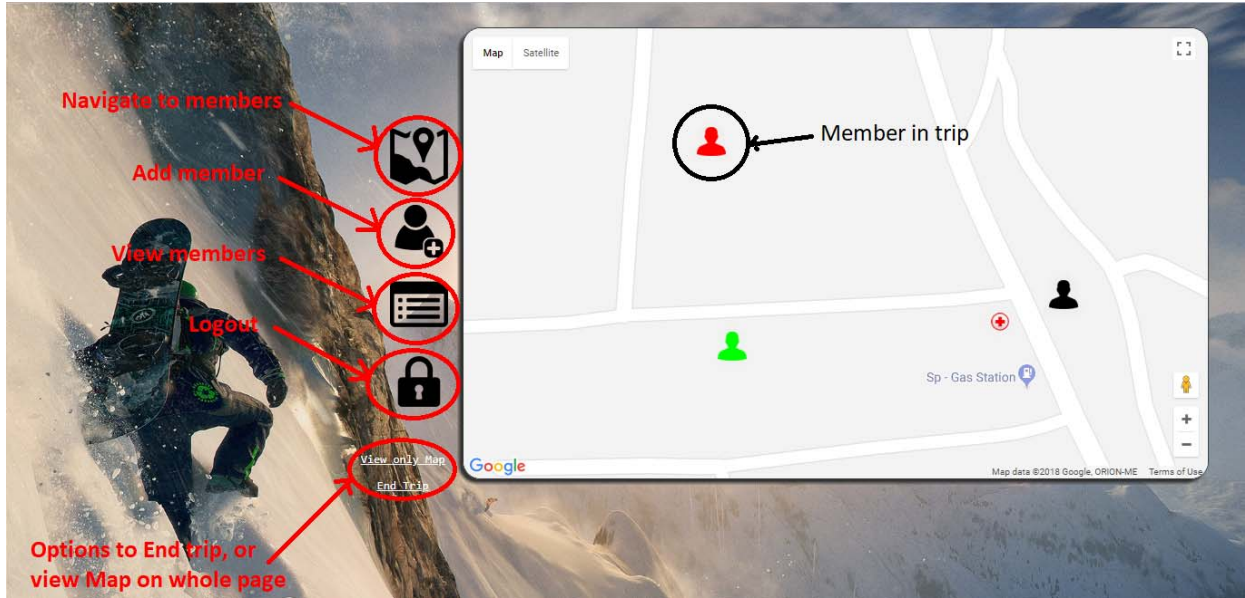

Figure 16: The main webpage shows the maps with markers

a black marker indicates that no more heart beats are detected any longer; an emergency sign indicates that the soldier has a normal health status and needs help. An option of viewing only the Map on a full screen mode is available. The leader can also use the Web page to add, remove, and view any member of his team and their personal information as shown in Figure 17 and Figure 18. After each trip, the leader must press on End trip to clear the markers from the map.

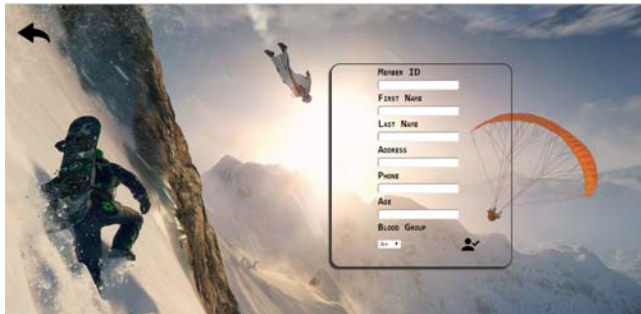

Figure 17: A page to add members to the team



Figure 18: A page to view team members or remove them

#### D. Android Application Development

We developed an Android application to allow the leader to use it instead of the Web page. This application allows the leader be able to track and monitor his team on a map as well as the website does. Figure 19 shows the main application page and the control panel that can be used by the leader.

Also, this app allows the leader to add members and show health statuses and personal information of members in trip displaying them in a list as shown in Figure 20.

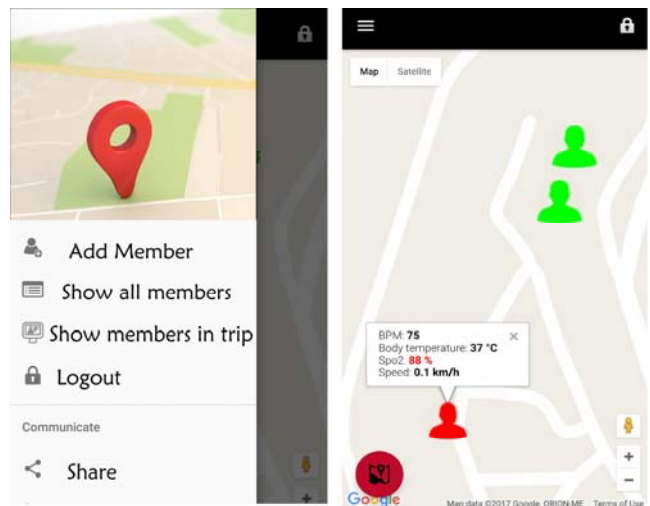

Figure 19: Maps and leader's control panel

In addition, the leader can view all his team members in a list showing if members are in trip or not as shown in Figure 21.



## V. CONCLUSION

The main objective of this paper was to present the design and implementation of a complete system for monitoring and tracking people's health information and location in a sport trip, battle, patients, etc. Our system provides a wearable device for each member and a portable device for the leader. This enhances the leader's ability to care about the band benefiting from a Web page and an Android application. This system has a humanitarian impact since it can decrease the effects of many issues in trips including unaccounted for and the difficulty of health status monitoring.

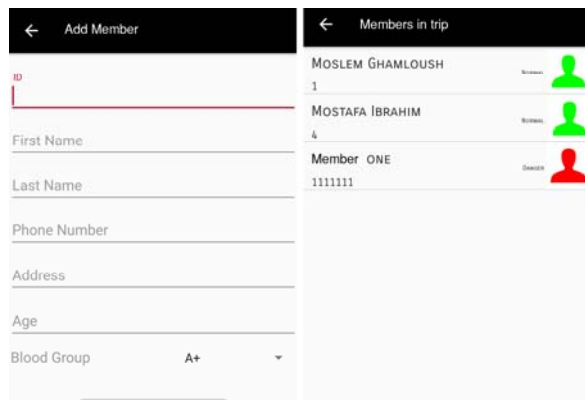

Figure 20: Add and show members in trip pages on Android application

The system security can be addressed using encryption technologies, such as AES (Advanced Encryption Standard) for the data exchanged between the central unit and the members. This system could be tested on real members to prove its applicability.

This system can be enhanced by providing an agreed upon secret code to be sent with the emergency button to prevent anyone from misusing this device. Moreover, the range of the WIFI signals is limited

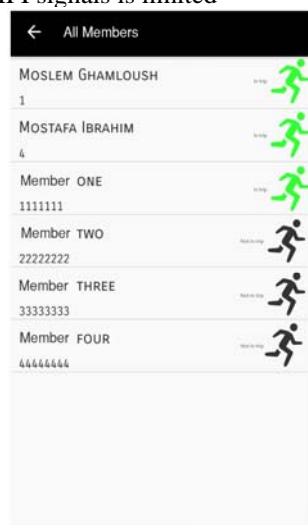

Figure 21: A page shows all members of team

100 m, and the GSM cannot be used because its signals are weak in the sports area or they do not even exist. Our system can also be improved by introducing a new communication system using microwave signals with frequencies lower than WIFI band (around 2.4 GHz).

## REFERENCES

- [1] A. Bazzi, M. Ghamloush, M. Ibrahim, M. Ghareeb, S. Abdul-Nabi, H. Khachfe, "Smart Military Healthcare Monitoring and Tracking System on Raspberry Pi," in *GLOBAL HEALTH 2017 : The Sixth International Conference on Global Health Challenges*, Barcelona, Spain, 2017.
- [2] D. Hunt, "Soldier Missing From Korean War Accounted For (Hunt)," [Online]. Retrieved May 10, 2018 from: <http://www.dpaa.mil/News-Stories/News-Releases/Article/1011148/soldier-missing-from-korean-war-accounted-for-hunt/>.
- [3] S. Howes, T. Ross, T. Hornall, "Tignes avalanche: At least four killed and five missing at ski resort popular with Brits," 13 February 2017. [Online]. Retrieved September 10, 2018 from: <https://www.mirror.co.uk/news/world-news/tignes-avalanche-least-four-killed-9809720>.
- [4] S. Smith, "GPS - An Important Technology to U.S. Troops," [Online]. Retrieved February 13, 2017 from: <https://www.thebalance.com/gps-an-important-technology-to-u-s-troops-3345076>.
- [5] C. H. Sterling, "Military Communications: From Ancient Times to the 21st Century", ABC-CLIO; 1 edition (October 16, 2007). p. 504.
- [6] J. J. Hilt, R. L. Jones "MTS: An Untold Commo Success Story in OIF.," *Field Artillery*, September-October 2004, pp. 30-32.
- [7] K. Aziz, S. Tarapiah, S. H. Ismail and S. Atalla, "Smart real-time healthcare monitoring and tracking system using GSM/GPS technologies," *2016 3rd MEC International Conference on Big Data and Smart City (ICBDSC)*, Muscat, 2016, pp. 1-7.
- [8] S. Mukherjee, K. Dolui, S.K. Datta, "Patient HealthManagement System using e-Health Monitoring Architecture," *2014 IEEE International Advance Computing Conference (IACC)*, Gurgaon, 2014, pp. 400-405.
- [9] "Arduino Uno & Genuino Uno," Arduino, 2017. Retrieved February 13, 2017 from: <https://www.arduino.cc/en/main/arduinoBoardUno>.
- [10] J. Murphy, Y. Gitman, "Pulse Sensor Advanced," Pulse sensor, 2011. [Online]. Retrieved February 13, 2017 from: <https://pulsesensor.com/pages/code-and-guide>.
- [11] Maxim, "Pulse Oximeter and Heart-Rate Sensor IC," Maxim integrated, [Online]. Retrieved February 13, 2017 from: <https://datasheets.maximintegrated.com/en/ds/MAX30100.pdf>.
- [12] David Thompson, "Raspberry Pi 3 Model B," [Online]. Retrieved February 13, 2017 from: <https://www.raspberrypi.org/products/raspberry-pi-3-model-b/>.



[www.iariajournals.org](http://www.iariajournals.org)

**International Journal On Advances in Intelligent Systems**

📄 issn: 1942-2679

**International Journal On Advances in Internet Technology**

📄 issn: 1942-2652

**International Journal On Advances in Life Sciences**

📄 issn: 1942-2660

**International Journal On Advances in Networks and Services**

📄 issn: 1942-2644

**International Journal On Advances in Security**

📄 issn: 1942-2636

**International Journal On Advances in Software**

📄 issn: 1942-2628

**International Journal On Advances in Systems and Measurements**

📄 issn: 1942-261x

**International Journal On Advances in Telecommunications**

📄 issn: 1942-2601